

Foreword

Welcome to the growing group of value-conscious people who drive Toyotas. We are proud of the advanced engineering and quality construction of each vehicle we build.

This Owner's Manual explains the features of your new Toyota. Please read it and follow the instructions carefully so that you can enjoy many years of safe motoring.

When it comes to service, remember that your Toyota dealer knows your vehicle best and is interested in your complete satisfaction. He will provide quality maintenance and any other assistance you may require.

Please leave this Owner's Manual in this vehicle at the time of resale. The next owner will need this information also.

All information and specifications in this manual are current at the time of printing. However, because of Toyota's policy of continual product improvement, we reserve the right to make changes at any time without notice.

Please note that this manual applies to all models and explains all equipment, including options. Therefore, you may find some explanations for equipment not installed in your vehicle.

TOYOTA MOTOR CORPORATION

® 1996 TOYOTA MOTOR CORPORATION

All rights reserved. This material may not be reproduced or copied, in whole or in part, without the written permission of Toyota Motor Corporation.

New vehicle warranty

Your new vehicle is covered by the following Toyota limited warranties:

- ◀ New vehicle warranty
- ◀ Emission control systems warranty
- ◀ Others

For further information, please refer to the separate “Owner’s Guide”, “Owner’s Manual Supplement” or “Warranty Booklet”.

Your responsibility for maintenance

It is the owner’s responsibility to make sure that the specified maintenance is performed. Part 6 gives details of these maintenance requirements. Also included in Part 6 is general maintenance. For scheduled maintenance information, please refer to the separate “Owner’s Manual Supplement/Maintenance Schedule”.

Accessories, spare parts and modification of your Toyota

A wide variety of non genuine spare parts and accessories for Toyota vehicles are currently available in the market. You should know that Toyota does not warrant these products and is not responsible either for their performance, repair or replacement, or for any damage they may cause to, or adverse effect they may have on, your Toyota vehicle.

This vehicle should not be modified with non genuine Toyota products. Modification with non genuine Toyota products could affect its performance, safety or durability, and may even violate governmental regulations. In addition, damage or performance problems resulting from the modification may not be covered under warranty.

Spark ignition system of your Toyota

The spark ignition system of your Toyota meets all requirements of the Canadian Interference-Causing Equipment Standard.

Installation of a mobile two-way radio system

As the installation of a mobile two-way radio system in your vehicle could affect electronic systems such as multipoint fuel injection systems/sequential multipoint fuel injection system, cruise control system, anti-lock brake system and SRS airbag system, be sure to check with your Toyota dealer for precautionary measures or special instructions regarding installation.

Scrapping of your Toyota

The SRS airbag devices in your Toyota contains explosive chemicals. If the vehicle is scrapped with the airbag left as it is, it may cause an accident such as a fire. Be sure to have the SRS airbag system removed and disposed of by a qualified service shop or by your Toyota dealer before you dispose of your vehicle.

Quick index

Ⓜ If a service reminder indicator or warning buzzer comes on	61
Ⓜ If your vehicle will not start	135
Ⓜ If your engine stalls while driving	138
Ⓜ If your vehicle overheats	139
Ⓜ If you have a flat tire	140
Ⓜ If your vehicle needs to be towed	146
Ⓜ Tips for driving during break-in period	117
Ⓜ How to start the engine	129
Ⓜ General maintenance	158
Ⓜ Complete index	203

Gas station information

Fuel type:

Premium UNLEADAD gasoline, Research Octane Number 96 (Octane Rating 91) or higher

See page 117 for detailed information.

Fuel tank capacity:

70 L (18.5 gal., 15.4 Imp. gal.)

Engine oil:

API SH, "Energy-Conserving II" multigrade engine oil or ILSAC multigrade engine oil is recommended.

Use SAE 5W-30 if normal temperatures are above -18°C (0°F).

See page 170 for detailed information.

Tire information: See pages 173 through 178.

Tire pressure: See page 198.

Publication No. OM14525U

Part No. 01999-14525

Printed in Japan 01-9607-00 1

スーブラ(北米U)

Part 1

OPERATION OF INSTRUMENTS AND CONTROLS—

Chapter 1–1

Overview of instruments and controls

- ④ Instrument panel overview
- ④ Instrument cluster overview
- ④ Indicator symbols on the instrument panel

Instrument panel overview

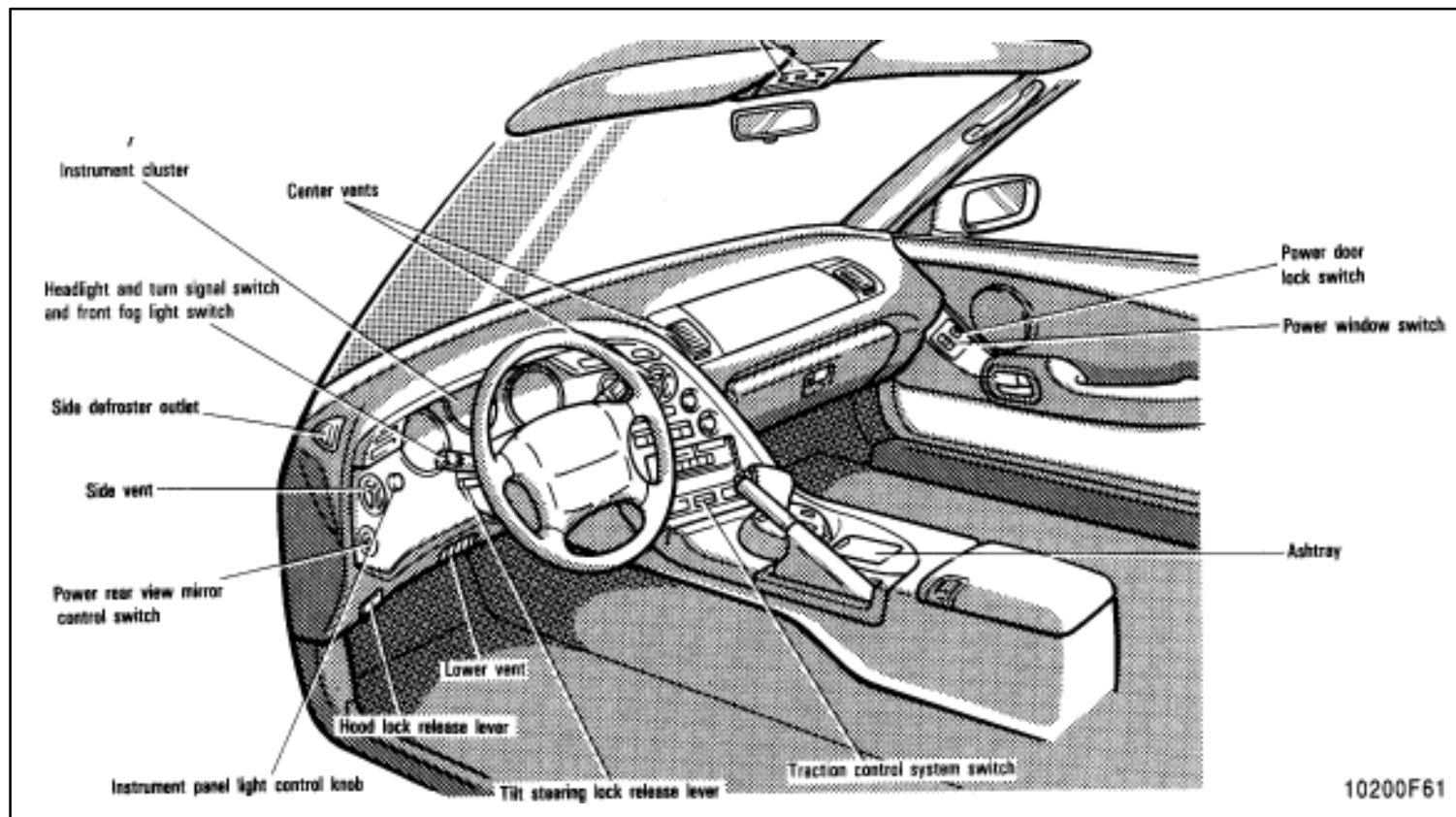

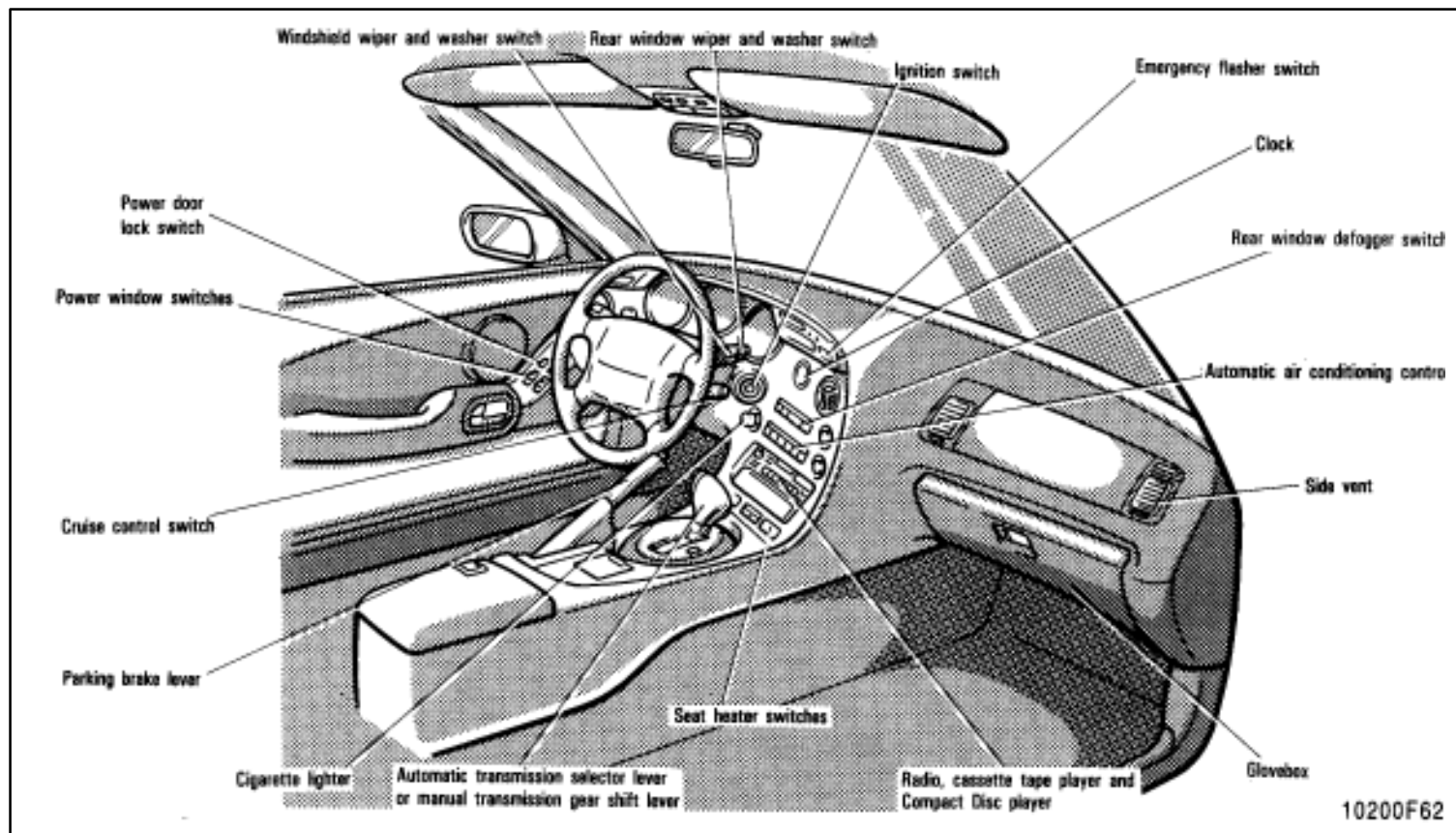



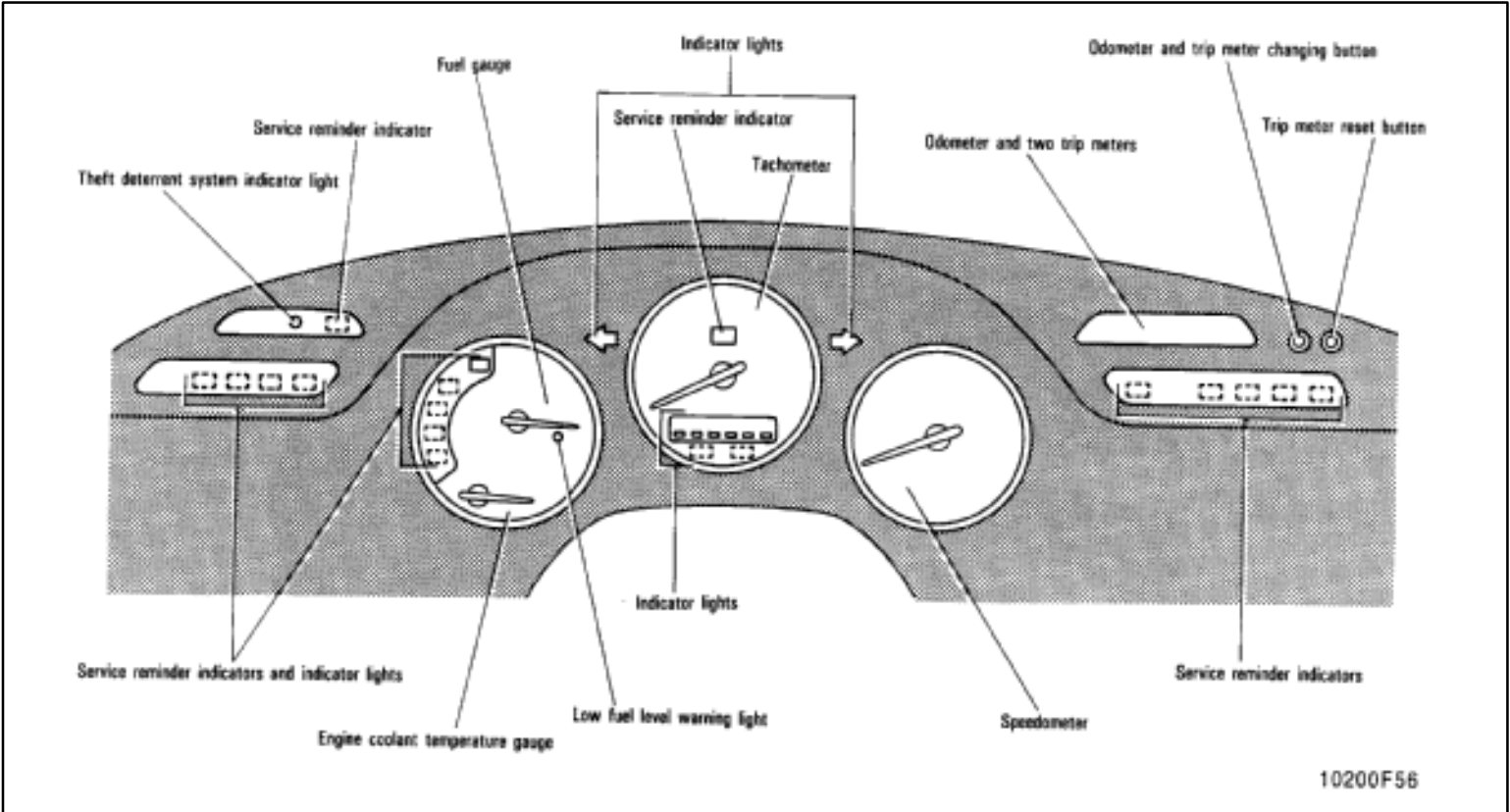















Instrument cluster overview



Indicator symbols on the instrument panel

	Master warning light *1
BRAKE (type A)  (type B)	Brake system warning light *1
	Seat belt reminder light*1
	Discharge warning light*1
	Malfunction indicator light*1
	Low oil pressure warning light*1
	Low engine oil level warning light*1

ABS (type A)  (type B)	Anti-lock brake system warning light *1
	Open door warning light*1
	Rear light failure warning light*1
	SRS airbag warning light*1
TRAC OFF	Traction control system off indicator/ warning light*1
	Slip indicator light
SNOW	Snow mode indicator light

	Turn signal indicator lights
	Headlight high beam indicator light
	Overdrive-off indicator light
	Automatic transmission manual mode indicator light *2
	Automatic transmission indicator lights
	Cruise control indicator light *3

*1: For details, see “Service reminder indicators and warning buzzers” in Chapter 1–5.

*2: If this light flashes, see “Automatic transmission” in Chapter 1–6.

*3 If this light flashes, see “Cruise control” in Chapter 1–6.

Part 1

OPERATION OF INSTRUMENTS AND CONTROLS—

Chapter 1–2

Keys and Doors

- Ⓡ Keys
- Ⓡ Side doors
- Ⓡ Power windows
- Ⓡ Back door
- Ⓡ Hood
- Ⓡ Theft deterrent system
- Ⓡ Fuel tank cap
- Ⓡ Sport roof

Keys

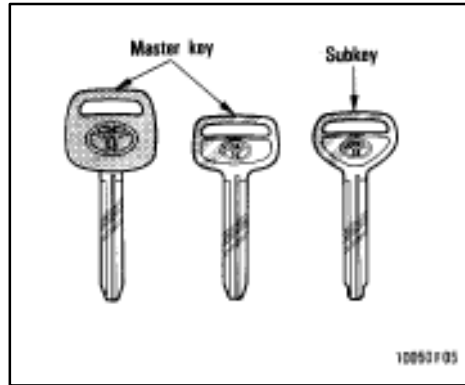

The master key works in every lock. The subkey will not work in the glovebox.

To protect things locked in the glovebox when you have your vehicle parked, leave the subkey with the attendant.

Since the side doors and back door can be locked without a key, you should always carry a spare master key in case you accidentally lock your keys inside the vehicle.

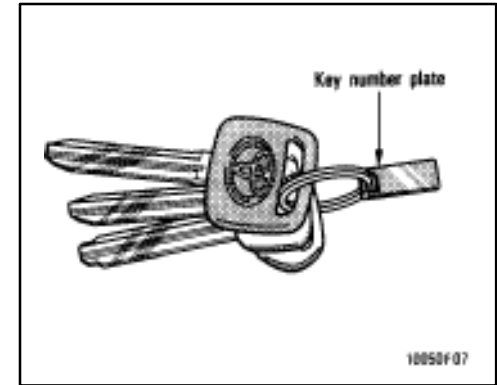

Keep the key number plate in a safe place such as your wallet, not in the vehicle.

If you should lose your keys or if you need additional keys, duplicates can be made by a Toyota dealer using the key number.

You should also put a copy of the key number with your important papers.

Side doors

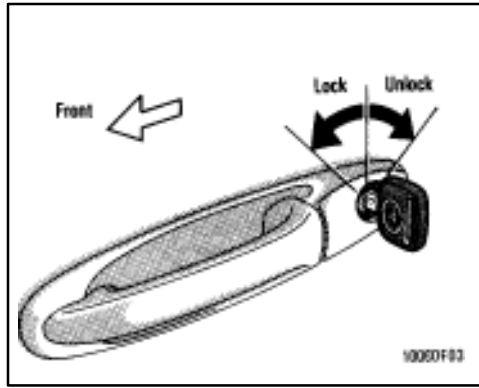

LOCKING WITH KEY

Turn the key toward the front of the vehicle to lock and towards the back to unlock.

Both doors locks and unlock simultaneously with either door. In the driver's door lock, turning the key once will unlock the driver's door and twice in succession will unlock both doors simultaneously.

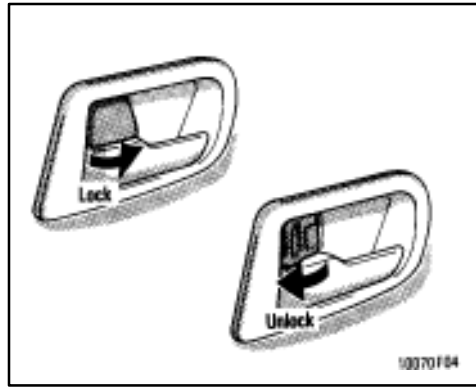

LOCKING WITH INSIDE LOCK KNOB

Turn the lock knob forward to lock and backward to unlock the door.

Closing the door with the lock knob in the lock position will also lock the door. Be careful not to lock your keys in the vehicle. The door cannot be locked if you leave the key in the ignition switch.

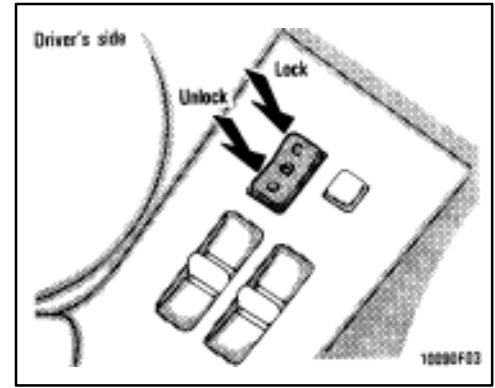

LOCKING WITH POWER DOOR LOCK SWITCH

To lock both of the doors simultaneously, push the power door lock switch on the LOCK side. Pushing on the UNLOCK side will unlock them.

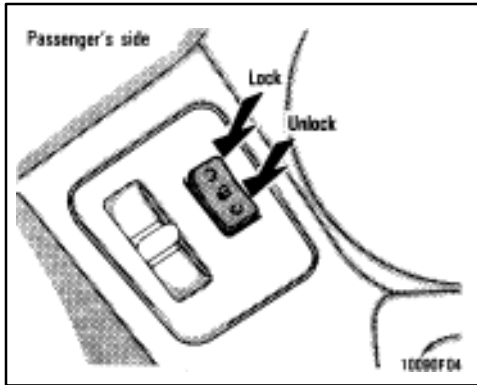

! CAUTION

Before driving, be sure that the doors are closed and locked, especially when small children are in the vehicle. Along with the proper use of seat belts, locking the doors helps prevent the driver and passengers from being thrown out from the vehicle during an accident. It also helps prevent the doors from being opened unintentionally.

Power windows

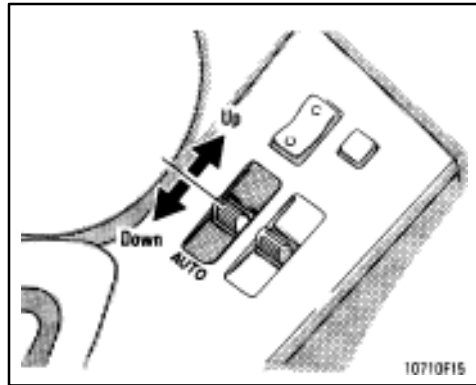

The windows can be operated with the switch on each side door.

The power windows work when the ignition switch is in the "ON" position. However, if both side doors are closed, they work for 60 seconds even after the ignition-switch is turned off. They stop working when either side door is opened.

OPERATING THE DRIVER'S WINDOW

Use the switch on the driver's door.

Normal operation: The window moves as long as you hold the switch.

To open: Lightly pull down the switch.

To close: Push up the switch.

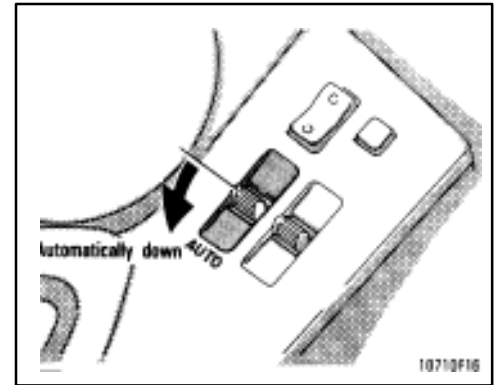

Automatic operation (to open only):

Pull the switch completely down and then release it. The window will fully open. To stop the window partway, lightly push the switch up and then release it.

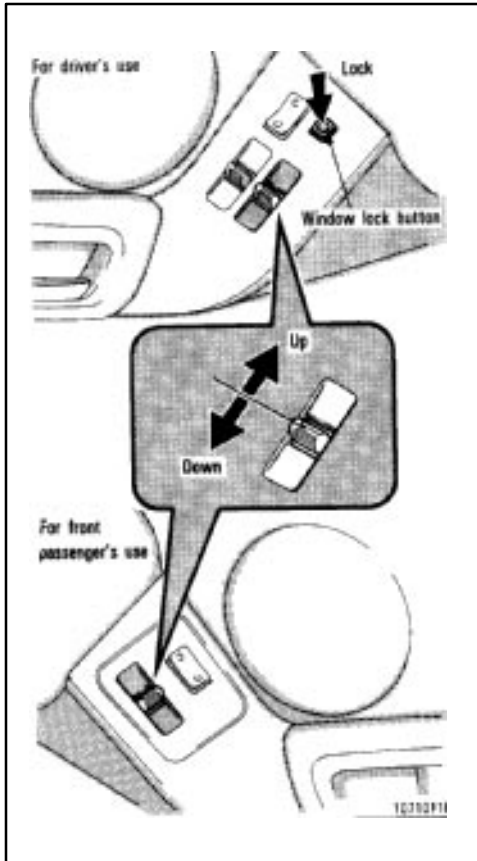

OPERATING THE PASSENGER'S WINDOW

Use the switch on the passenger's door. The driver's door also has a switch that controls the passenger's window.

The window moves as long as you hold the switch.

To open: Pull down the switch.

To close: Push up the switch.

If you push in the window lock button on the driver's door, the passenger's window cannot be operated.



To avoid serious personal injury, you must do the following.

- Ⓡ Always make sure the head, hands and other parts of the body of all occupants are kept completely inside the vehicle before you close the power windows. If someone's neck, head or hands gets caught in a closing window, it could result in a serious injury. When anyone closes the power windows, be sure that they operate the windows safely.
- Ⓡ When small children are in the vehicle, never let them use the power window switches without supervision. Use the window lock button to prevent them from making unexpected use of the switches.
- Ⓡ Never leave small children alone in the vehicle, especially with the ignition key still inserted. They could use the power window switches and get trapped in a window. Unattended children can become involved in serious accidents.

Back door—

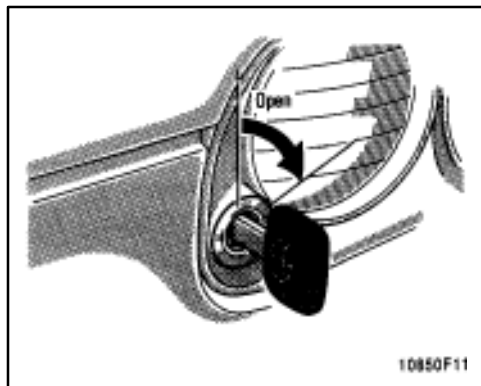

To open the back door from the outside, insert the key and turn it clockwise.

See “Luggage storage precautions” in Part 2 for precautions to observe in loading luggage.

To close the back door, lower it and press down on it. After closing the back door, try pulling it up to make sure it is securely closed.



Keep the back door closed while driving. This not only keeps the luggage from being thrown out but also prevents exhaust gases from entering the vehicle.

—Lock release lever

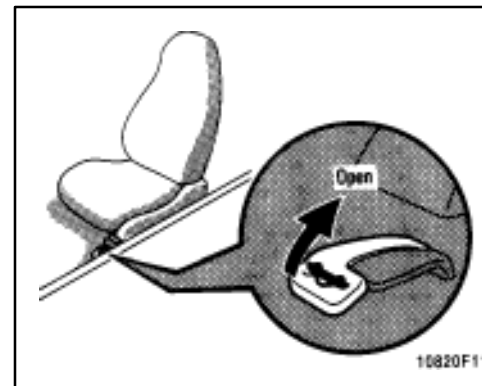

To open the back door from the driver's seat, pull up on the lock release lever.

Hood

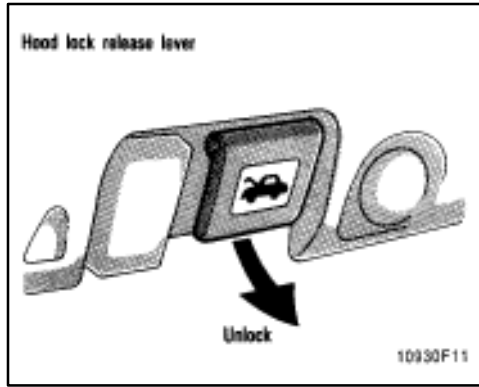

To open the hood, do the following.

1. Pull the hood lock release lever.
The hood will spring up slightly.

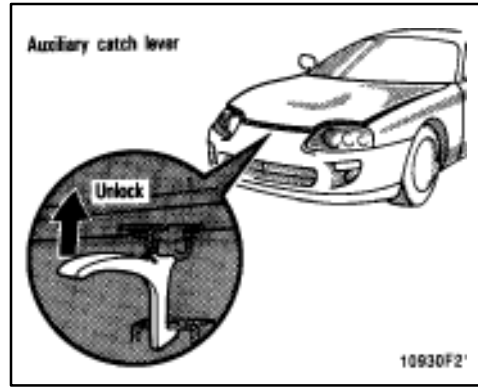

2. In front of the vehicle, pull up on the auxiliary catch lever and lift the hood.

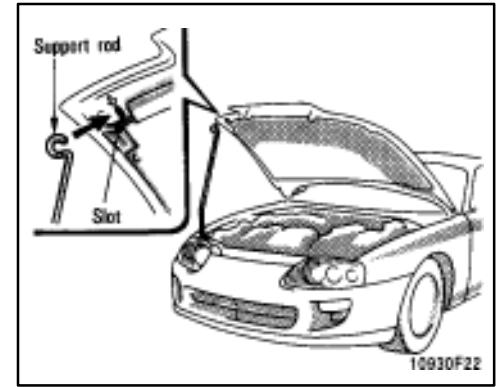

3. Hold the hood open by inserting the support rod into the slot.

Before closing the hood, check to see that you have not forgotten any tools, rags, etc. and return the support rod to its clip—this prevents rattles.



After inserting the rod, make sure it supports the hood security.

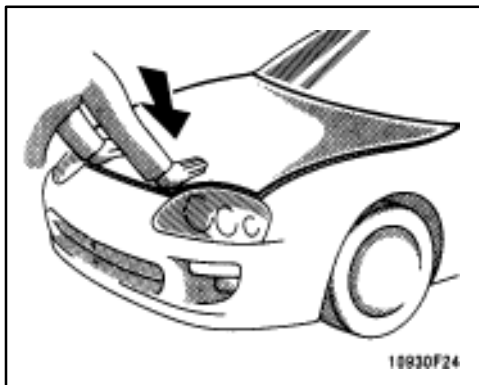
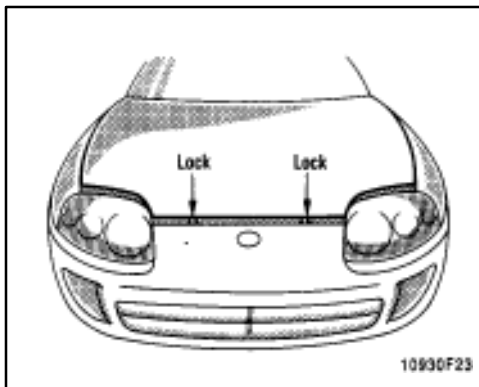

Your Supra has two hood locks at the front edge of the hood.

To close the hood, lower the hood until it is about 30 cm (12 in.) above the engine compartment and release it. If the hood is still not fully closed, press down on it above the two hood locks. Make sure the hood is locked securely.

If you notice while driving that the hood is not locked, stop the vehicle at once and close the hood.

! CAUTION

When closing the hood, be careful not to get your hands caught between the hood and the vehicle body.

NOTICE

Do not press hard on the hood except above the hood locks, or you may deform the hood.

Theft deterrent system



To deter the vehicle theft, the system is designed to give an alarm and keep the engine from being started if any of the side doors, back door or hood is forcibly unlocked or the battery terminal is disconnected and then reconnected when the vehicle is locked.

The alarm blows the horn intermittently and flashes the headlights, tail lights and other exterior lights. The engine cannot be started because the starter circuit will be cut.

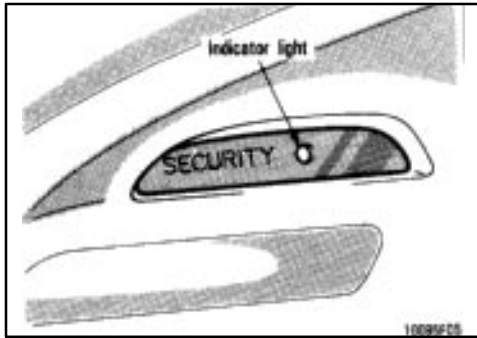

SETTING THE SYSTEM

1. Turn the ignition key to the “LOCK” position and remove it.
2. Have all passengers get out of the vehicle.
3. Close and lock all the side doors, back door and hood.

The indicator light will come on when all the side doors, back door and hood are closed and locked.

As the side doors are locked, the system will give you a preparation time of 30 seconds before the setting, during which the side doors, back door and hood may be opened to prepare for the setting.

Be careful not to use the key when opening any side door. This will cancel the system.

4. After making sure the indicator light starts flashing, you may leave the vehicle.

The system will automatically be set after the preparation time passes. The indicator light will flash to show the system is set. If any of the side doors, back door or hood is open at that time, the setting is interrupted until it is closed and locked.

Never leave anyone in the vehicle when you set the system, because unlocking from the inside will activate the system.

WHEN THE SYSTEM IS SET

Activating the system

The system will give the alarm and cut the starter circuit under the following conditions:

- Ⓡ If any of the side doors, back door or hood is unlocked without using the key.
- Ⓡ If the battery terminal is disconnected and then reconnected

After one minute, the alarm will automatically stop with the starter circuit cut kept on.

Reactivating the alarm

Once set, the system automatically resets the alarm each time all the side doors, back door and hood are closed after the alarm stops.

The alarm will be activated again under the following conditions:

- Ⓡ If any of the side doors, back door or hood is opened
- Ⓡ If the battery terminal is disconnected and then reconnected

Stopping the alarm

Turn the ignition key from the “LOCK” to “ACC” position. The alarm will be stopped with the starter circuit cut kept on. Stopping the alarm in this manner will keep the alarm from being reactivated when any of the side doors, back door or hood is opened.

Interrupting the setting

When the system set, the back door can be opened by using the key without setting off the system. While the back door is open, the setting is interrupted and the side doors and hood may be opened in addition. However, when the battery terminal is disconnected and then reconnected, the system is activated.

Close and lock the side doors and hood, and the system will automatically be reset after two seconds when the back door is closed with the key removed.

CANCELLING THE SYSTEM

Unlock either side door with the key.

This cancels the system completely and the starter circuit cut will be cancelled at once.

INDICATOR LIGHT

The indicator light gives the following three indications.

FLASHING—The system is set. You need the key to open the side doors, back door and hood.

ON—The system will automatically be set when the time comes. The side doors, back door and hood may be opened without a key.

OFF—The system is inactive. You may open any door, trunk and hood.

TESTING THE SYSTEM

1. Open the windows
2. Set the system as described above. The side doors should be locked with the key. Be sure to wait until the indicator light starts flashing.
3. Unlock either side door from the inside. The system should activate the alarm
4. Cancel the system by unlocking either side doors with the key.
5. Repeat this operation for the other side doors, back door and hood. When testing on the hood, also check that the system is activated when the battery terminal is disconnected and then reconnected.

If the system does not work properly, have it checked by your Toyota dealer.

Fuel tank cap

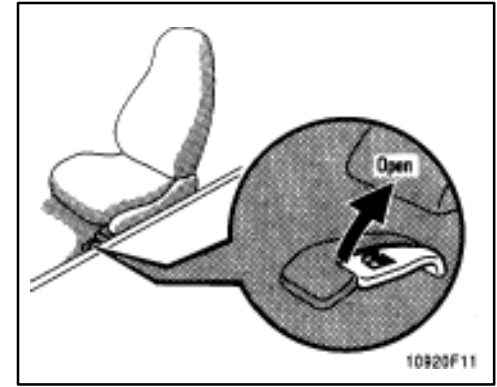

1. To open the fuel filler door, pull the lever up.



- Ⓡ Do not smoke, cause sparks or allow open flames when refuelling. The fumes are flammable.
- Ⓡ When opening the cap, do not remove the cap quickly. In hot weather, fuel under pressure could cause injury by spraying out of the filler neck if the cap is suddenly removed.

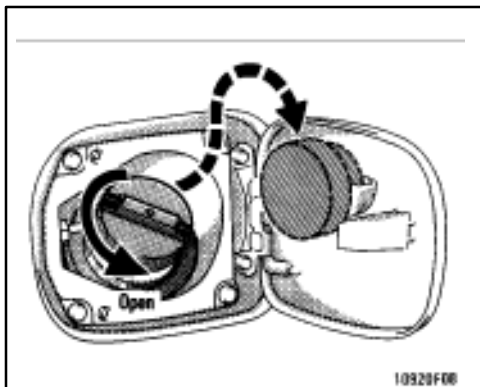

2. To remove the fuel tank cap, turn the cap slowly counterclockwise, then pause slightly before removing it. After removing the cap, hang it on the cap hanger.

It is not unusual to hear a slight swoosh when the cap is opened. When installing, turn the cap clockwise till you hear a click.



CAUTION

- ⑥ Make sure the cap is tightened securely to prevent fuel spillage in case of an accident.
- ⑥ Use only a genuine Toyota fuel tank cap for replacement. It has a built in check valve to reduce fuel tank vacuum.

Sport roof— —Detaching from vehicle

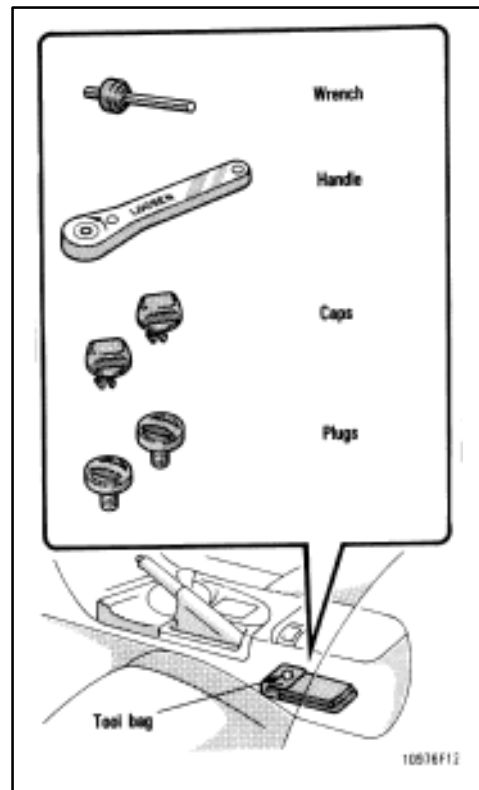

1. Get the tool bag out of the console box.

In the tool bag, you will find a special kit consisting of:

- ® Wrench and handle
 - For turning the center lock and the front and rear bolts
- ® Caps
 - For covering the front bolts
- ® Plugs
 - For stopping up the rear holes

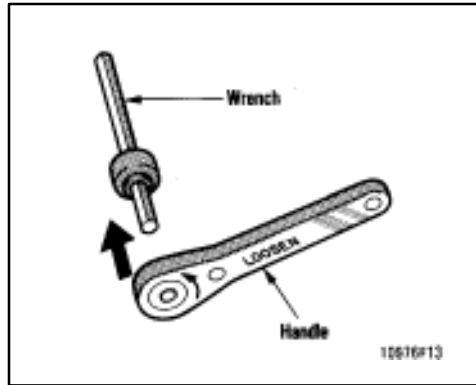

2. Face the “LOOSEN” side of the handle toward you and insert the wrench into the handle.

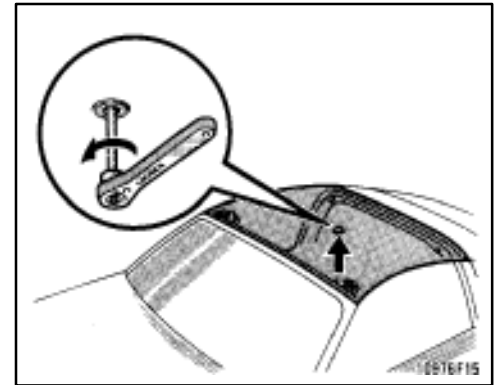

3. Unlock the center lock by inserting the wrench and turning it a 1/4 turn counterclockwise.

Before detaching the sport roof from the vehicle, fully open both of the side doors and windows, and clear the seats.

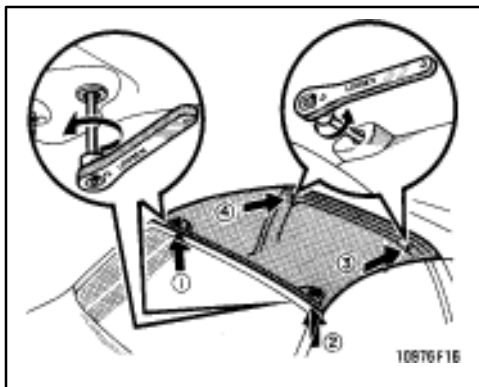

4. Loosen the bolts in the order shown by turning the wrench counterclockwise. Then lift up the front edge of the sport roof and lift off the roof forward.



Be careful not to get your hands or fingers caught between the sport roof and the vehicle body when detaching the roof.

NOTICE

Take care not to hit the sport roof against the vehicle body to avoid damage to the roof when detaching the roof.

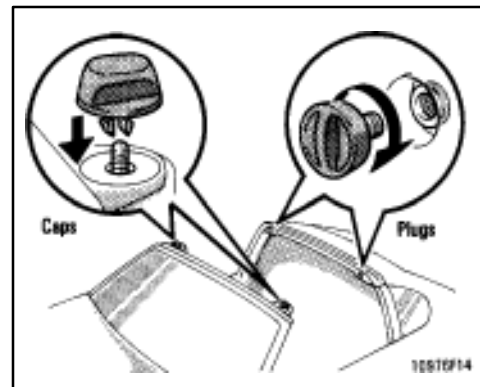

5. After removing the roof, put the caps on the front bolts and insert the plugs into the rear holes



- Ⓡ Do not stick your head, arms or any objects out of the opening while the vehicle is moving.
- Ⓡ Never attempt to remove the roof while driving.
- Ⓡ Do not sit on top of the vehicle around the opening.

—Stowing in luggage compartment

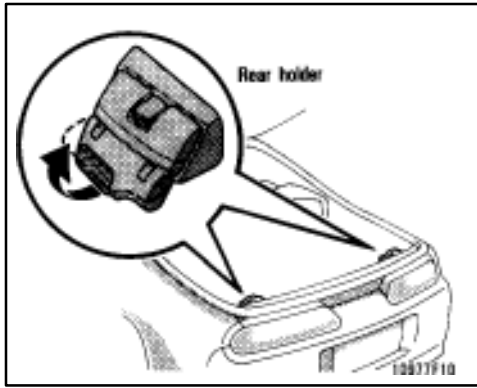

1. Open the back door and set up the rear holders as shown above.

Before stowing the roof in the luggage compartment, be sure to remove the luggage cover. (See “Luggage cover” in Chapter 1–8.)

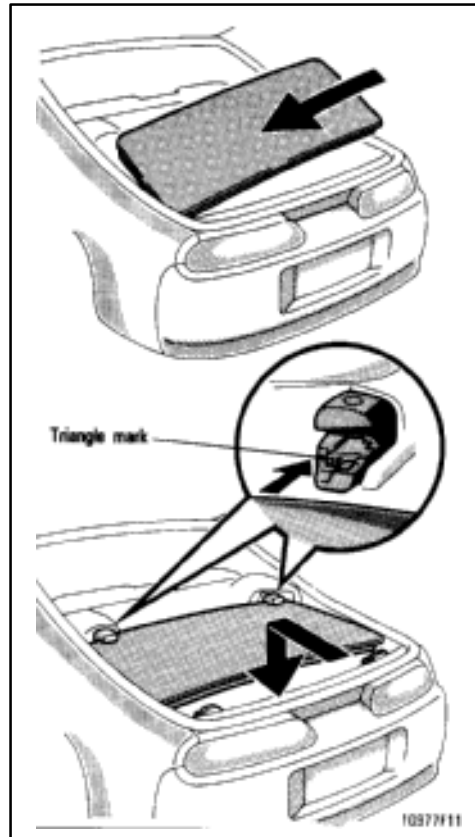

2. Put in the roof from the left side as shown. Then insert the front edge of the roof in the front holders, and engage the rear edge with the rear holders.

Put the front edge on the triangle marks of the front holders.

To engage the rear edge of the roof with the rear holders, put the rear edge on the holders while pushing the front edge fully forward against the front holders.



To minimize the risk of personal injury, make sure all four corners of the roof are securely locked in the holders after installation.

NOTICE

To avoid damage the roof panel, do not press on the center of the stowed roof panel and do not put anything on the stowed roof panel.

—Reinstalling on vehicle

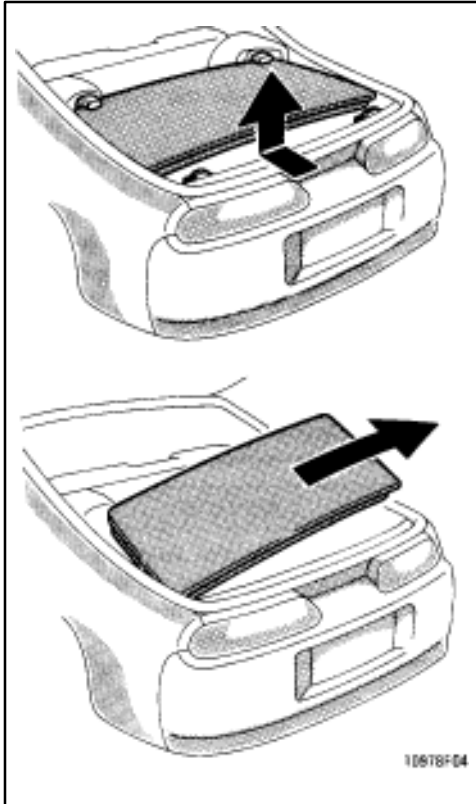

1. Lift up the rear edge while pushing the roof fully forward, then pull the front edge out of the holders. Remove the roof from the right side as shown.

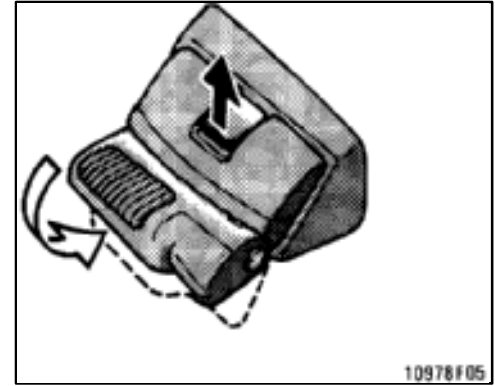

After removing the roof, put back the rear holders by pulling up the lock release knob.

NOTICE

Do not operate the knob until the roof has been removed.

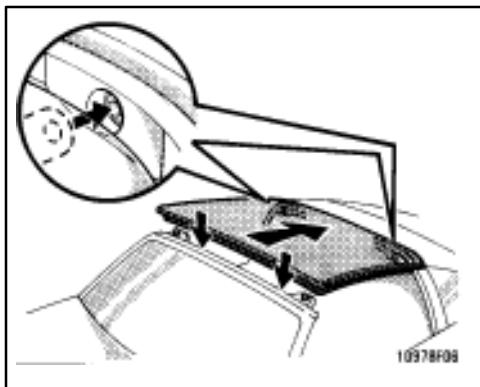

2. Place the rear edge on first and then the front edge.

Before installation, be sure to take the caps and plugs off.



To minimize the risk of personal injury, make sure all four corners are securely fixed on the brackets after installation.

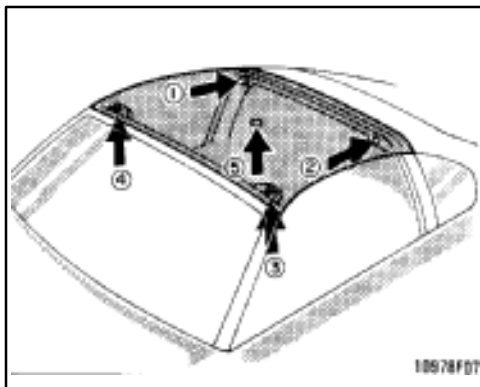

3. Tighten the bolts and lock the center lock in the order shown. (See “-Detaching from vehicle” for details.)

Note that all five connections need to be tight to secure the sport roof.

Reverse the wrench handle so the “TIGHTEN” side faces toward you and turn it clockwise.

Check that the roof is correctly installed by lightly trying to move the roof.

Put the wrench, handle, caps and plugs back in the tool bag in the console box.



CAUTION

Make sure to tighten all four bolts and to lock the center lock when installing the sport roof.

Part 1

OPERATION OF INSTRUMENTS AND CONTROLS—

Chapter 1–3

Seats, Seat belts, Steering wheel and Mirrors

- Ⓡ Seats
- Ⓡ Front seats
- Ⓡ Fold-down rear seat
- Ⓡ Seat heaters
- Ⓡ Seat belts
- Ⓡ SRS airbags
- Ⓡ Child restraint
- Ⓡ Tilt steering wheel
- Ⓡ Outside rear view mirrors
- Ⓡ Anti-glare inside rear view mirror

Seats

While the vehicle is being driven, all vehicle occupants should have the seatback upright, sit well back in the seat and properly wear the seat belt provided.



- Ⓡ Do not drive with the occupants not properly seated such as sitting on top of a folded-down seatback, or in the luggage compartment. Persons not properly seated and not properly restrained by seat belts can be severely injured in the event of emergency braking or a collision.
- Ⓡ During driving, do not allow passengers to stand up or move around between seats. Severe injuries can occur in the event of emergency braking or a collision.

Front seats—

—Seat adjustment precautions

Adjust the driver's seat so that the foot pedals, steering wheel and instrument panel controls are within easy reach of the driver.



- Ⓡ Adjustments should not be made while the vehicle is moving, as the seat may unexpectedly move and cause the driver to lose control of the vehicle.
- Ⓡ When adjusting the seat, be careful not to hit the seat against a passenger, luggage or rear seat.
- Ⓡ After adjusting the seat position, try sliding it forward and backward to make sure it is locked in position.
- Ⓡ After adjusting the seatback, exert body pressure to make sure it is locked in position.
- Ⓡ Do not put objects under the seats as they may interfere with the seat-lock mechanism or unexpectedly push up the seat position adjusting lever; the seat may suddenly move, causing the driver to lose control of the vehicle.

—Adjusting front seats (manual seat)

Ⓜ While adjusting the seat, do not put your hands under the seat or near the moving parts. You may catch and injure your hands or fingers.



ADJUSTING SEAT POSITION

Pull the lock release lever up. Then slide the seat to the desired position with slight body pressure and release lever.

ADJUSTING SEATBACK ANGLE

Lean forward and pull the lock release lever. Then lean back to the desired angle and release the lever.



To reduce the risk of sliding under the lap belt during a collision, avoid reclining the seatback any more than needed. The seat belts provide maximum protection when the driver and the passenger are sitting up straight and well back in the seats. If you are reclined, the lap belt may slide past your hips and apply restraint forces directly to the abdomen. Therefore, in the event of a frontal collision, the risk of personal injury may increase with increasing recline of the seatback.

—Adjusting front seats (power seat)

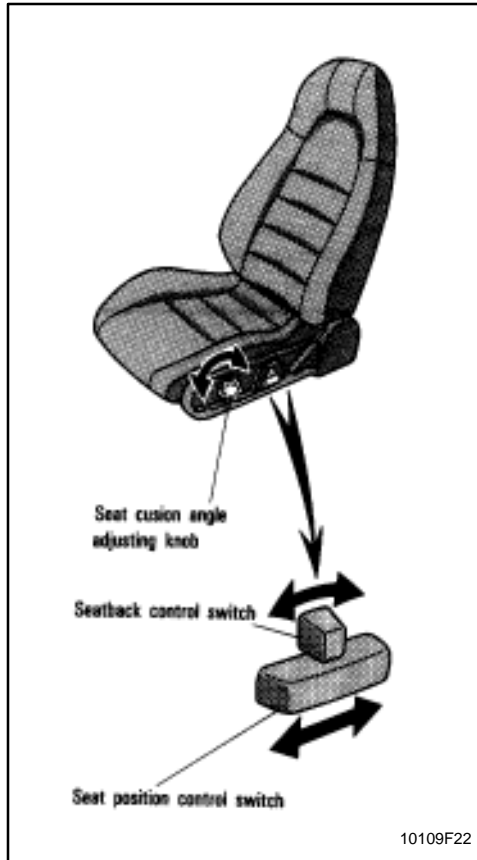

ADJUSTING SEAT POSITION

Move the control switch to the desired direction.

Releasing the switch will stop the seat at that position.

Do not place anything under the front seats. It might interfere with the seat movement.

ADJUSTING SEATBACK ANGLE

Move the control switch in the desired direction.

Releasing the switch will stop the move in that position.



To reduce the risk of sliding under the lap belt during a collision, avoid reclining the seatback any more than needed. The seat belts provide maximum protection when the driver and the passenger are sitting up straight and well back in the seats. If you are reclined, the lap belt may slide past your hips and apply restraint forces directly to the abdomen. Therefore, in the event of a formal collision, the risk of personal injury may increase with increasing recline of the seatback.

ADJUSTING SEAT CUSHION ANGLE

Turn the knob either way.

—Tilting driver's seatback for rear seat entry

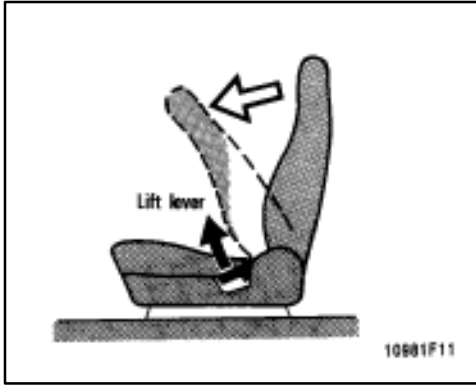

Lift seatback lock release lever—the seatback will tilt forward.

This allows passengers to get into or out of the rear seat easily. After passengers are in lift up on the seatback.



CAUTION

After putting back the seatback, try pushing the seatback forward and rearward to make sure it is secured in place.

—Moving passenger's seat for rear seat entry

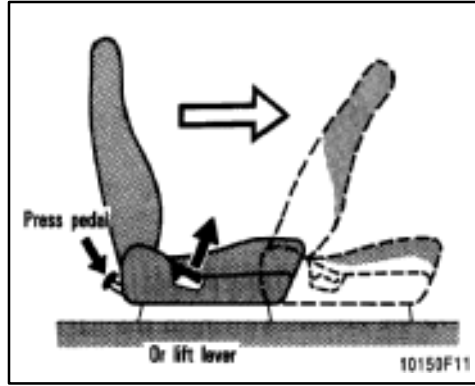

For easy access to the rear seat, do this.

1. Lift the seatback lock release lever or press the release pedal. The seat will slide forward slightly.
2. Move the seat to the front-most position.

After passengers are in, lift up the seatback and return the seat until it locks.



CAUTION

- ⑥ **After putting back the seat, try pushing the seatback forward and rearward to make sure it is secured in place.**
- ⑥ **Never allow anyone to rest their foot on the release pedal while the vehicle is moving.**

Fold-down rear seat

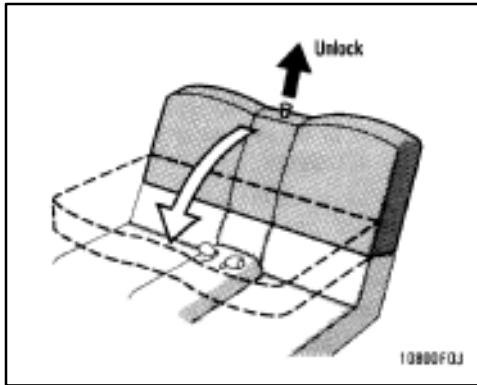

FOLDING DOWN REAR SEAT

Unlock the seatback, and fold it down.

This will enlarge the luggage compartment as far as the front seatbacks. See “Luggage stowage precautions” in Part 2 for precautions to observe in loading luggage.

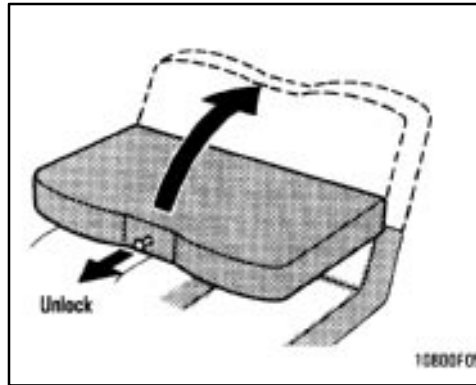

SETTING UP REAR SEAT

Unlock the seatback, and set it up.



When returning the seatback to the upright position:

- Ⓢ **Make sure the seat belts are not twisted or caught in the seatback and are arranged in their proper position for ready to use.**
- Ⓢ **Make sure the seatback is securely locked by pushing forward and rearward on the top of the seatback.**

Seat heaters

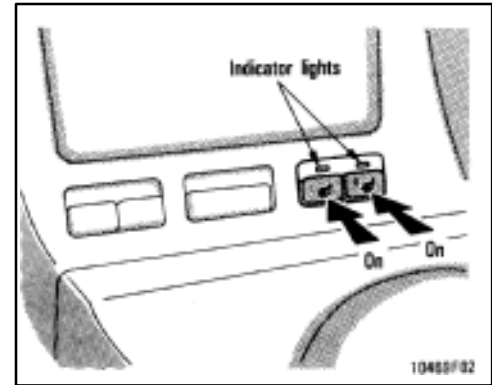

To turn on the seat heater, push the “L” switch for the driver’s seat, and “R” switch for the passenger’s seat.

The key must be in the “ON” position.

Once the seat is warmed up, the heat of the seat heater is reduced automatically. The indicator light above the switch illuminates when the seat heater is operating.



CAUTION

Use control for persons who are mentioned below in the use of the seat heater because it may make them feel too hot or cause burns at low temperatures (erythema, varicella).

- ⑧Baby, small child, elderly person, sick person or handicapped person
- ⑧Persons who have delicate skin
- ⑧Persons who are exhausted
- ⑧Drunk person or those who have taken drugs which induce sleep (sleeping drug, cold remedy, etc.)

To prevent the seat overheating, do not use the seat heater with a blanket, cushion, or other insulating objects which cover the seat.

NOTICE

◀***Do not put unevenly weighed objects on the seat and do not stick sharp objects (needles, nails, etc.) on the seat.***

◀***When cleaning the seats, do not use organic substances (paint thinner, benzine, alcohol, gasoline, etc.). They may damage the heater and seat surface.***

◀***To prevent the battery from being discharge, turn the switch on when the engine is running.***

Seat belts— —Seat belt precautions

Toyota strongly urges that the driver and passengers in the vehicle be properly restrained at all times with the seat belts provided. Failure to do so could increase the chance of injury and/or the severity of injury in accidents.

Child. Use a child restraint system appropriate for the child until the child becomes large enough to properly wear the vehicle's seat belts. See "Child restraint" for details.

If a child is too large for a child restraint system, the child should sit in the rear seat and must be restrained using the vehicle's seat belt. According to accident statistics, the child is safer when properly restrained in the rear seat than in the front seat.

If a child must sit in the front seat, the seat belts should be worn properly. If an accident occurs and the seat belts are not worn properly, the force of the rapid inflation of the airbag may cause serious injury to the child.

Do not allow the child to stand up or kneel on either rear or front seats. An unrestrained child could suffer serious injury during emergency braking or a collision. Also, do not let the child sit on your lap. It does not provide sufficient restraint.



CAUTION

Use control for persons who are mentioned below in the use of the seat heater because it may make them feel too hot or cause burns at low temperatures (erythema, varicella).

- ⑧Baby, small child, elderly person, sick person or handicapped person
- ⑧Persons who have delicate skin
- ⑧Persons who are exhausted
- ⑧Drunk person or those who have taken drugs which induce sleep (sleeping drug, cold remedy, etc.)

To prevent the seat overheating, do not use the seat heater with a blanket, cushion, or other insulating objects which cover the seat.

NOTICE

◀***Do not put unevenly weighed objects on the seat and do not stick sharp objects (needles, nails, etc.) on the seat.***

◀***When cleaning the seats, do not use organic substances (paint thinner, benzine, alcohol, gasoline, etc.). They may damage the heater and seat surface.***

◀***To prevent the battery from being discharge, turn the switch on when the engine is running.***

Seat belts— —Seat belt precautions

Toyota strongly urges that the driver and passengers in the vehicle be properly restrained at all times with the seat belts provided. Failure to do so could increase the chance of injury and/or the severity of injury in accidents.

Child. Use a child restraint system appropriate for the child until the child becomes large enough to properly wear the vehicle's seat belts. See "Child restraint" for details.

If a child is too large for a child restraint system, the child should sit in the rear seat and must be restrained using the vehicle's seat belt. According to accident statistics, the child is safer when properly restrained in the rear seat than in the front seat.

If a child must sit in the front seat, the seat belts should be worn properly. If an accident occurs and the seat belts are not worn properly, the force of the rapid inflation of the airbag may cause serious injury to the child.

Do not allow the child to stand up or kneel on either rear or front seats. An unrestrained child could suffer serious injury during emergency braking or a collision. Also, do not let the child sit on your lap. It does not provide sufficient restraint.

If the shoulder belt falls across the child's neck or face, have the child sit slightly closer to the buckle side to the seat so that the belt lays across the shoulder.

Pregnant woman. Toyota recommends the use of a seat belt. Ask your doctor for specific recommendations. The lap belt should be worn securely and as low as possible over the hips and not on the waist.

Injured person. Toyota recommends the use of a seat belt. Depending on the injury, first check with your doctor for specific recommendations.



CAUTION

Persons should ride in their seats properly wearing their seat belts whenever the vehicle is moving. Otherwise, they are much more likely to suffer serious bodily injury in the event of sudden braking or a collision.

When using the seat belts, observe the following:

③ Use the belt for only one person at a time. Do not use a single belt for two or more people—even children.

⑧ **Avoid reclining the seatbacks too much. The seat belts provide maximum protection when the seatbacks are in the upright position. (See the seat adjustment instructions.)**

⑧ **Be careful not to damage the belt webbing or hardware. Take care that they do not get caught or pinched in the seat or doors.**

⑧ **Inspect the belt system periodically. Check for cuts, fraying, and loose parts. Damaged parts should be replaced. Do not disassemble or modify the system**

⑧ **Keep the belts clean and dry. If they need cleaning, use a mild soap solution or lukewarm water. Never use bleach, dye, or abrasive cleaners—they may severely weaken the belts.**

⑧ **Replace the belt assembly (including bolts) if it has been used in a severe impact. The entire assembly should be replaced even if damage is not obvious.**

—Seat belts



Adjust the seat as needed (front seats only) and sit up straight and well back into the seat. To fasten your belt, pull it out of the retractor and insert the tab into the buckle.

You will hear a click when the tab locks into the buckle.

The seat belt length automatically adjusts to you size and the seat position.

The retractor will lock the belt during a sudden stop or on impact. It also may lock if you lean forward too quickly. A slow, easy motion will allow the belt to extend, and you can move around freely.

If the seat belt cannot be pulled out of the retractor, firmly pull the belt and release it. You will then be able to smoothly pull the belt out of the retractor.

When a passenger's shoulder belt is completely extended and is then retracted even slightly, the belt is locked in that position and cannot be extended. This feature is used to hold the child restraint system securely. (For details, see "Child restraint" in this chapter.) To free the belt again, fully retract the belt and then pull the belt out once more.



CAUTION

- Ⓜ **After inserting the tab, make sure the tab and buckle are locked and that the belt is not twisted.**
- Ⓜ **Do not insert coins, clips, etc. in the buckle as this may prevent you from properly latching the tab and buckle.**
- Ⓜ **If the seat belt does not function normally, immediately contact your Toyota dealer.**

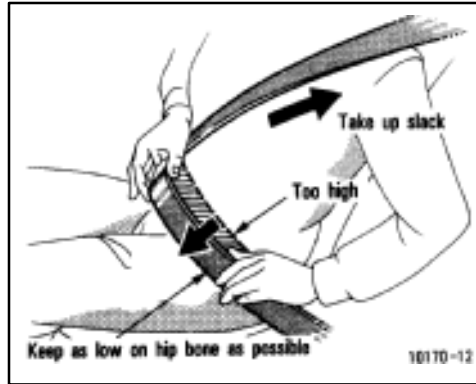

Adjust the position of the lap and shoulder belts

Position the lap belt as low as possible on your hips—not your waist, then adjust it to a snug fit by pulling the shoulder portion upward through the latch plate.



CAUTION

- Ⓜ **High-positioned lap belts and loose-fitting belts both could increase the chance of injury due to sliding under the lap belt during an accident or other unintended result. Keep the lap belts as low on your hip bone as possible.**
- Ⓜ **For your safety, do not place the shoulder belt under your arm.**

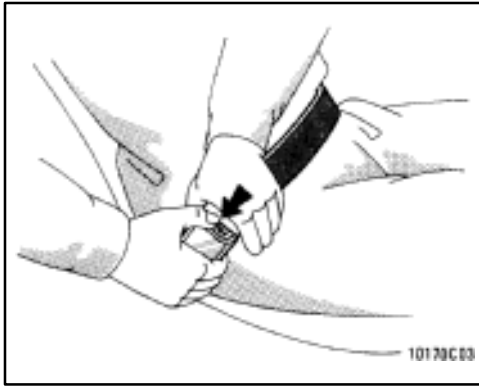

To release the belt, press the buckle-release button and allow the belt to retract.

If the belt does not retract smoothly, pull it out and check for kinks or twists. Then make sure it remains untwisted as it retracts.

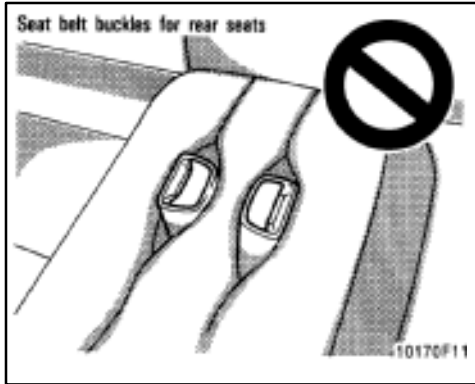

 **CAUTION**

For your safety, do not use the rear seat belts with the buckle in the rear seats.

—Seat belt extender

If your seat belt cannot be fastened securely because it is not long enough, a personalized seatbelt extender is available from your Toyota dealer free of charge.

Please contact your local Toyota dealer so that the dealer can order the proper required length for the extender. Bring the heaviest coat you expect to wear for proper measurement and selection of length. Additional ordering information is available at your Toyota dealer.

 **CAUTION**

When using the seat belt extender, observe the following. Failure to follow these instructions could result in less effectiveness of the seat belt restraint system in case of vehicle accident, increasing the chance of personal injury.

Ⓢ Never use the seat belt extender if you can fasten the seat belt without it.

ⓈRemember that the extender provided for your may not be safe when used on a different vehicle, or for another person or at a different seating position than the one originally intended for.

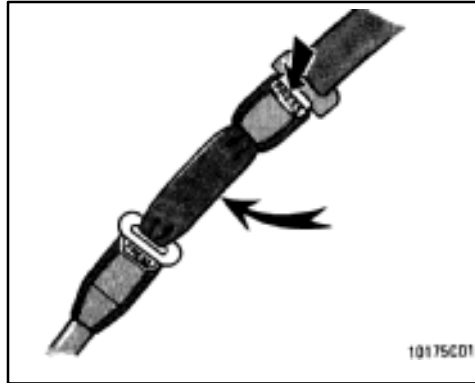

To connect the extender to the seat belt, insert the tab into the seat belt buckle so that the “PRESS” signs on the buckle—release buttons of the extender and the seat belt are both facing outward as shown.

You will hear a click when the tab locks into the buckle.

When releasing the seat belt, press on the buckle—release button on the extender, not on the seat belt. This helps prevent damage to the vehicle interior and extender itself.

When not in use, remove the extender and store in the vehicle for future use.



CAUTION

- ⓈAfter inserting the tab, make sure the tab and buckle are locked and that the seat belt extender is not twisted.
- ⓈDo not insert coins, clips, etc. in the buckle as this may prevent you from properly latching the tab and buckle.
- ⓈIf the seat belt does not function normally, immediately contact your Toyota dealer.

SRS airbags

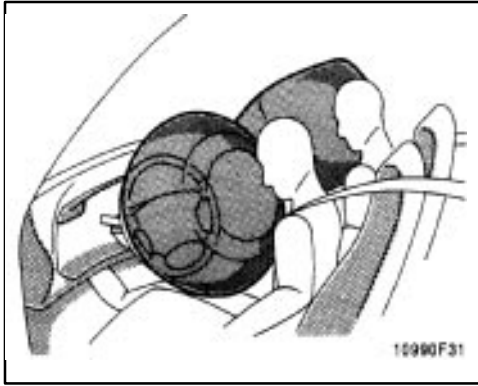

The SRS (Supplemental Restraint System) airbags are designed to provide further protection to the driver and front passenger when added to the primary protection provided by the seat belts.

In response to a severe frontal impact, the SRS airbags work together with the seat belts to help preventing or reduce injury by inflating, in order to decrease the likelihood of the driver's or front passenger's head or chest directly hitting the steering wheel or dashboard. The passenger airbag is activated even with no passenger in the front seat.

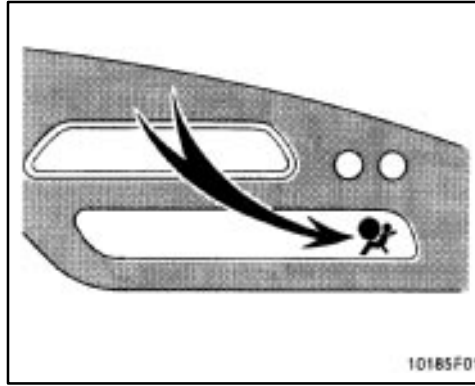

This indicator comes on when the ignition key is turned to the “ACC” or “ON” position. It goes off after about 6 seconds. This means the SRS airbags are operating properly.

The SRS airbag warning light system monitors the airbag sensor assembly, inflators, warning light, interconnecting wiring and power sources.

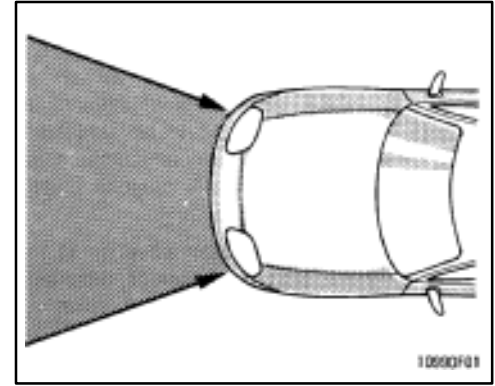

The SRS airbag system is designed to activate in response to a severe frontal impact within the shaded area between the arrows in the illustration.

The SRS airbags will deploy if the severity of the impact is above the designed threshold level, comparable to an approximate 20 km/h (14 mph) collision when impacting straight into a fixed barrier that does not move or deform.

If the severity of the impact is below the above threshold level, the SRS airbags may not deploy.

However, this threshold velocity will be considerably higher if the vehicle strikes an object, such as a parked vehicle or sign pole, which can move or deform on impact, or if it is involved in an underride collision (e.g. a collision in which the nose of the vehicle “underrides”, or goes under, the bed of a truck).

It is possible with collision severity at the marginal level of airbag sensor detection and activation that only one of your vehicle’s two airbags will deploy.

For the safety of all occupants, be sure to always wear seat belts.

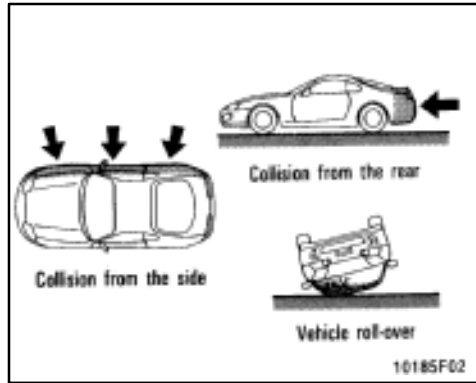

The SRS airbags are not designed to inflate if the vehicle is subjected to a side or rear impact, if it rolls over, or if it is involved in a low-speed frontal collision.

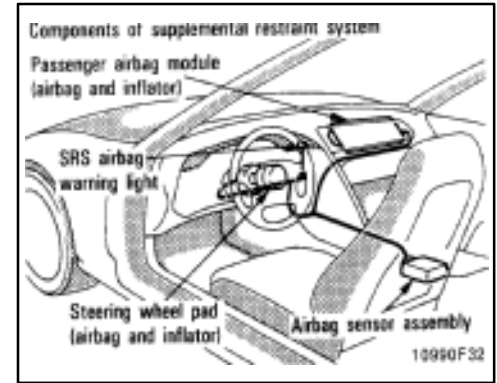

The airbag sensor assembly consists of a safing sensor and airbag sensor.

In a severe frontal impact, sensors detect deceleration and the system triggers the airbag inflators. Then a chemical reaction in the inflators momentarily fills the airbags with non-toxic nitrogen gas to help restrain the forward motion of the occupants.

When the airbags inflate, they produce a fairly loud noise and release some smoke along with the nitrogen or argon gas. This is not harmful and does not indicate a fire. Be sure to wash off any residue as soon as possible to prevent minor skin irritation. Deployment of the airbags happen in a fraction of a second, so the airbags must inflate with considerable force. While the system is designed to reduce serious injuries, it may also cause minor burns or abrasions and swellings.

Parts of the airbag module (steering wheel hub, dashboard) may be hot for several minutes, but the airbags themselves will not be hot. The airbags are designed to inflate only once.

A crash severe enough to inflate the airbags may break the windshield as the vehicle buckles. In vehicles with a passenger airbag the windshield may also be damaged by absorbing some of the force of the inflating airbag.



- ®The SRS airbag system is designed only as a supplement to the primary protection of the driver side and front passenger side seat belt systems. The front seat occupants are particularly susceptible to injury if they do not wear their seat belts; when sudden braking or a collision occurs, they may be thrown forward. To obtain maximum protection in an accident, the driver and all passengers in the vehicle should always wear their seat belts when driving because serious injuries can result to unrestrained occupants. For instructions and precautions concerning the seat belt systems, see "Seat belts" in this chapter.
- ®A baby or small child who is too small to use a seat belt should be properly secured in a rear seat using a child restraint system.



- ®Never put a rear-facing child restraint system in the front seat because the force of the rapid inflation of the passenger airbag can cause severe injury to the child. Vehicles with a passenger airbag display a caution label on the passenger side instrument panel as shown above to remind you not to install a rear-facing child restraint system on the front seat.

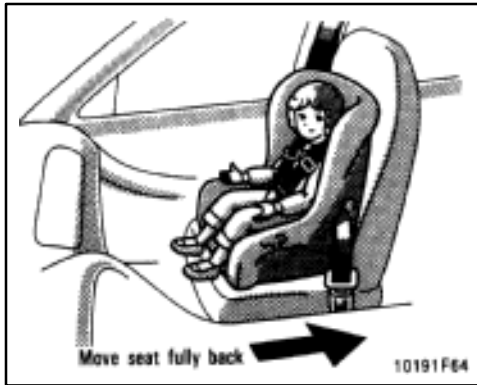

Ⓜ If you must use a forward-facing child restraint system in the front seat, the seat must be moved as far back as possible. For instructions concerning the installation of a child restraint system, see “Child restraint” in this chapter.

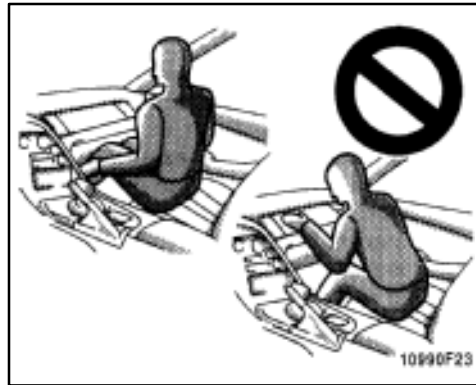

Ⓜ Do not sit on the edge of the seat or lean over the dashboard when the vehicle is in use. The airbags inflate with considerable speed and force; you may be severely injured. Sit up straight and well back in the seat, and always use your seat belt.



Ⓜ Do not allow a child to stand up, or to kneel on the front passenger seat. The airbag inflates with considerable speed and force; the child may be severely injured.

Ⓜ Do not hold a child on your lap or in your arms. Use a child restraint system in the rear seat. For instructions concerning the installation of a child restraint system, see “Child restraint” in this chapter.



Failure to follow these instructions can result in death or serious injuries.

NOTICE

Do not perform any of the following changes without consulting your Toyota dealer. Such changes can interfere with proper operation of the SRS airbag system in some cases.

- ◀ *Installation of electronic items such as a mobile two-way radio, cassette tape player or compact disc player*
- ◀ *Modification of the suspension system*
- ◀ *Modification of the front end structure*
- ◀ *Attachment of a grille guard (bull bar, kangaroo bar, etc.), snowplow, winches or any other equipment to the front end*
- ◀ *Repairs made on or near the front end structure, console, steering column, steering wheel or dashboard near the front passenger airbag*

- Ⓡ **Do not put objects on or in front of the dashboard or steering wheel pad that houses the airbag system. They might restrict inflation or cause personal injury as they are projected rearward.**
- Ⓡ **Do not modify, remove or open any components or wiring, such as the steering wheel column cover, front passenger airbag cover, front passenger airbag, airbag sensor assembly. Doing any of these may cause sudden SRS airbag inflation or disable the system, which could result in personal injury.**

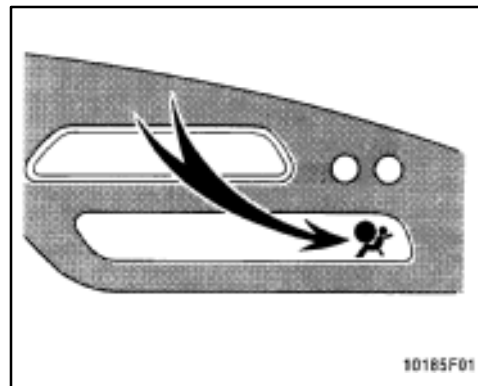

This SRS airbag system has a service reminder indicator to inform the driver of operating problems. If either of the following conditions occurs, this indicates a malfunction of the airbags. Contact your Toyota dealer as soon as possible to service the vehicle.

- Ⓡ The light does not come on when the ignition key is turned to the "ACC" or "ON" position, or remains on.
- Ⓡ The light comes on while driving.

Child restraint— —Child restraint precautions

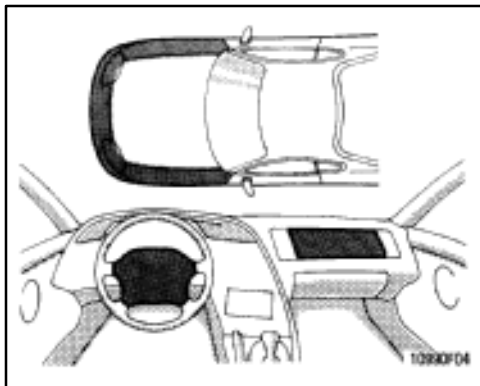

In the following cases, contact your Toyota dealer as soon as possible:

- ® The SRS airbags have been inflated.
- ® The front part of the vehicle (shaded in the illustration) was involved in an accident not of the extent to cause the SRS airbags to inflate
- ® The pad section of the steering wheel or front passenger airbag cover (shaded in the illustration) is scratched, cracked, or otherwise damaged.

Toyota strongly urges the use of child restraint systems for children small enough to use them.

The laws of all fifty states in the U.S.A. and Canada now require the use of a child restraint system.

Your vehicle conforms to SAEJ1819.

If a child is too large for a child restraint system, the child should sit in the rear seat and must be restrained using the vehicle's seat belt. See "Seat belts" for details.



- ® **For effective protection in automobile accidents and sudden stops, children must be properly restrained using a seat belt or child restraint system depending on the age and size of the child. Holding a child in your arms is not a substitute for a child restraint system. In an accident, the child can be crushed against the windshield, or between you and the vehicle's interior.**

® **Toyota strongly urges use of a proper child restraint system which conforms to the size of the child and is put on the rear seat. According to accident statistics, the child is safer when properly restrained in the rear seat than in the front seat.**

® **Never install a rear-facing child restraint system on the front seat. In the event of an accident, the force of the rapid inflation of the airbag can cause severe if a rear-facing child restraint system is put on the front seat.**

® **Unless it is unavoidable, do not put a forward-facing child restraint system on the front seat.**

® **If you must install a forward-facing child restraint system on the front seat, move the seat as far back as possible.**

® **Make sure that you have complied with all installation instructions provided by the child restraint manufacturer and that the system is properly secured.**

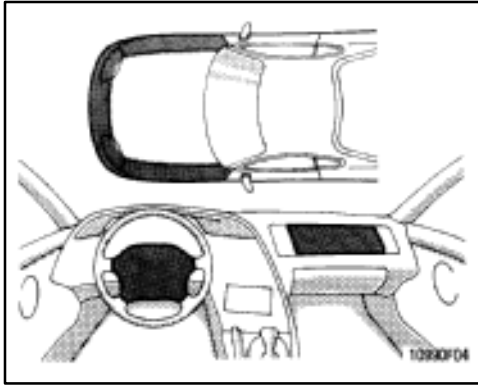

In the following cases, contact your Toyota dealer as soon as possible:

- ® The SRS airbags have been inflated.
- ® The front part of the vehicle (shaded in the illustration) was involved in an accident not of the extent to cause the SRS airbags to inflate
- ® The pad section of the steering wheel or front passenger airbag cover (shaded in the illustration) is scratched, cracked, or otherwise damaged.

Child restraint— —Child restraint precautions

Toyota strongly urges the use of child restraint systems for children small enough to use them.

The laws of all fifty states in the U.S.A. and Canada now require the use of a child restraint system.

Your vehicle conforms to SAEJ1819.

If a child is too large for a child restraint system, the child should sit in the rear seat and must be restrained using the vehicle's seat belt. See "Seat belts" for details.



® **For effective protection in automobile accidents and sudden stops, children must be properly restrained using a seat belt or child restraint system depending on the age and size of the child. Holding a child in your arms is not a substitute for a child restraint system. In an accident, the child can be crushed against the windshield, or between you and the vehicle's interior.**

® **Toyota strongly urges use of a proper child restraint system which conforms to the size of the child and is put on the rear seat. According to accident statistics, the child is safer when properly restrained in the rear seat than in the front seat.**

® **Never install a rear-facing child restraint system on the front seat. In the event of an accident, the force of the rapid inflation of the airbag can cause severe if a rear-facing child restraint system is put on the front seat.**

® **Unless it is unavoidable, do not put a forward-facing child restraint system on the front seat.**

® **If you must install a forward-facing child restraint system on the front seat, move the seat as far back as possible.**

® **Make sure that you have complied with all installation instructions provided by the child restraint manufacturer and that the system is properly secured.**

—Child restraint system

A child restraint system for a small child or baby must itself be properly restrained on the seat with either the lap belt or the lap portion of the lap/shoulder belt. You must carefully consult the manufacturer's instructions which accompany your child restraint system.

To provide proper restraint, use a child restraint system following the manufacturer's instructions about the appropriate age and size of the child for the child restraint system.

Install the child restraint system correctly following the instructions provided by its manufacturer of the system.

Toyota recommends installing the child restraint system on the rear seat. According to accident statistics, the child is safer when properly restrained in the rear seat than in the front seat.



- Ⓡ Never install a rear-facing child restraint system on the front seat. In the event of an accident, the force of the rapid inflation of the airbag can cause death or serious injury if a rear-facing child restraint system is installed on the front seat.**
- Ⓡ Unless it is unavoidable, do not install a forward-facing child restraint system on the front seat.**
- Ⓡ If you must install a forward-facing child restraint system on the front seat, move the seat as far back as possible.**
- Ⓡ After installing the child restraint system, make sure it is secured in place following the manufacturer's instructions. If it is not restrained securely, it may cause injury to the child in the event of a sudden stop or accident.**

When not using the child restraint system, keep it secured with the seat belt. This will prevent it injuring passengers in the event of a sudden stop or accident.

Your vehicle has anchors for securing the top strap of a child restraint system. The anchor nuts are welded beneath the sheet metal to permit installation of an anchor bracket for a child restraint system.

To install an anchor bracket, use an 8 mm X 30 mm X 1.25 mm coarse thread metric bolt and 15mm (0.6 in.) spacer. Note that the bolts accompanying many child restraint systems are not metric. You can damage the anchor nuts on our vehicle if you force bolts with different thread into the anchor nuts.

For instructions about how to install the anchor bracket, see "Top strap anchors and locations."

If your child restraint system does not provide any of the necessary parts, you can purchase the following items from your Toyota dealer.

- * CRS installation kit
(Part No. 04731-22012)—contains 1 bolt, 3 types of spacers and 1 locking clip.
- * Bolt (Part No. 91511-60830)

—Types of child restraint system

Child restraint systems are classified into the following 3 types depending on the child's age and size.

- (A) Infant seat
- (B) Convertible seat
- (C) Booster seat

Install the child restraint system following the instructions provided by its manufacturer.

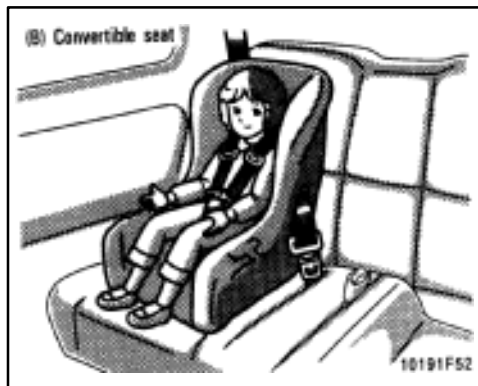
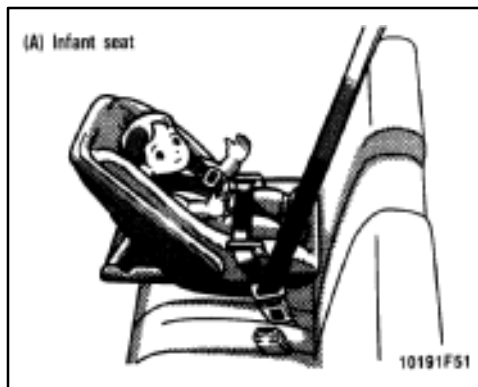

—Installation with 3-point type seat belt

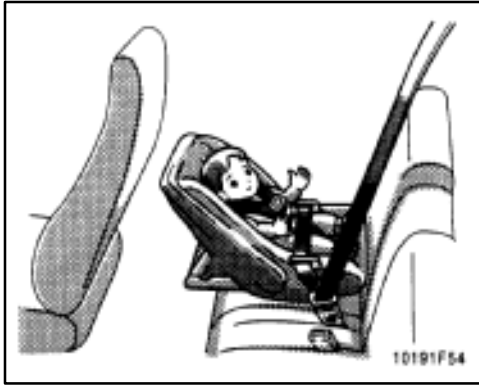

(A) INFANT SEAT INSTALLATION

An Infant seat is used in rear-facing only.



ⓈNever use rear-facing child restraint system in the front seat because the force of the rapid inflation of the passenger airbag can cause severe injury to the child. Vehicle with a passenger airbag display a caution label on the passenger side instrument panel as shown above to remind you not to install a rear-facing child restraint system on the front seat.

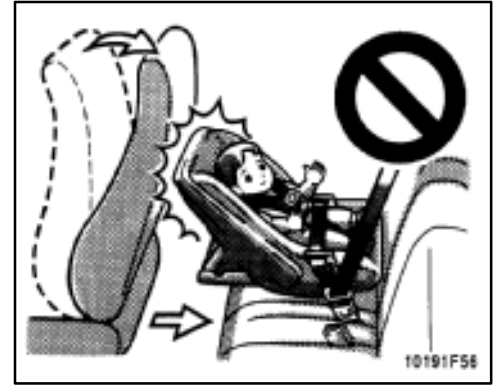

ⓈDo not use a rear-facing child restraint system in the rear seat if it interferes with the lock mechanism of the front seats. This can cause severe injury to the child and front passenger in case of sudden braking or a collision.

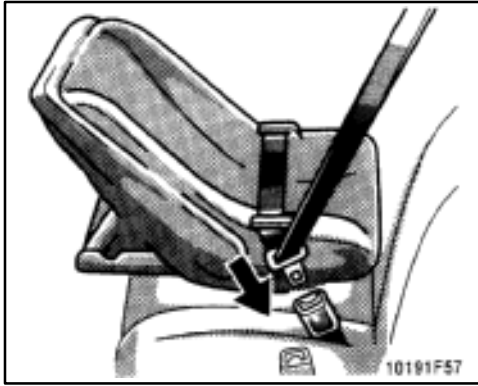

1. Run the lap and shoulder belt through or around the infant seat following the instructions provided by its manufacturer and insert the tab into the buckle taking care not to twist the belt. Keep the lap portion of the belt tight.

 **CAUTION**

- Ⓜ After inserting the tab, make sure the tab and buckle are locked and that the lap and shoulder portions of the belt is not twisted.
- Ⓜ Do not insert coins, clips, etc. in the buckle as this may prevent you from properly latching the tab and buckle.
- Ⓜ If the seat belt does not function normally, it cannot protect your child from injury. Contact your Toyota dealer immediately. Do not use the seat until the seat belt is fixed.

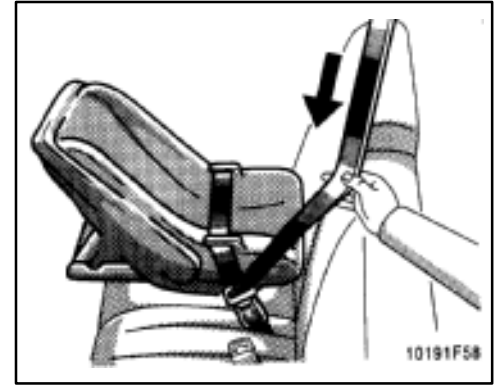

2. Fully extend the shoulder belt to put it in the lock mode. When the belt is then retracted even slightly, it cannot be extended.

To hold the infant seat securely, make sure the belt is in the lock mode before letting the before letting the belt to retract.

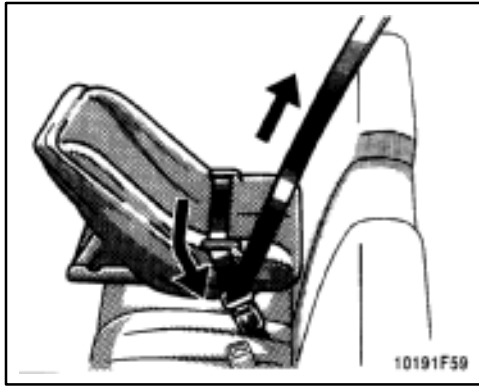

3. While pressing the infant seat firmly against the seat cushion and seat-back, let the shoulder belt retract as far as it will go to hold the infant seat securely.

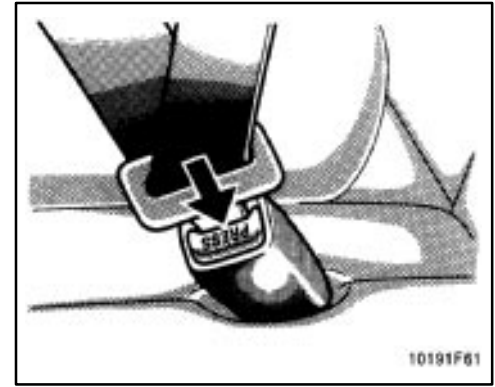
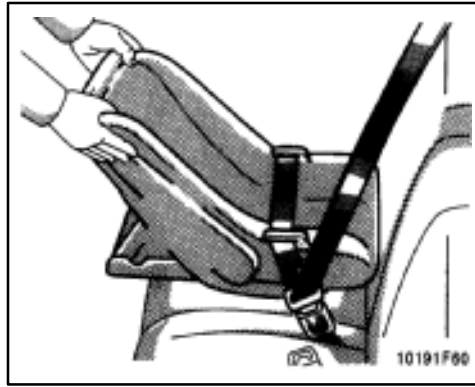

4. To remove the infant seat, press the buckle-release button and allow the belt to retract completely. The belt will move freely again and be ready to work for an adult or older child passenger.



CAUTION

Make sure the seat belt is securely locked. Also make sure the child restraint system is secure by pushing and pulling it in different directions. Follow all the installation instructions provided by its manufacturer.

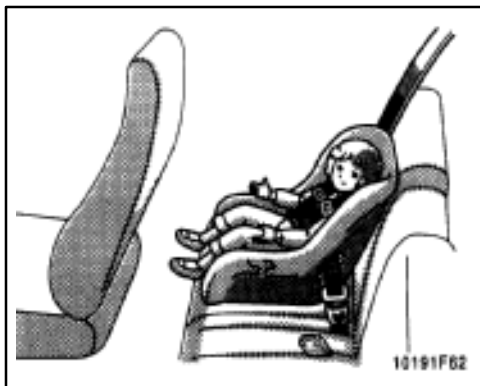

(B) CONVERTIBLE SEAT INSTALLATION

A convertible seats is used in forward-facing and rear-facing depending on the child's age and size. When installing, follow the manufacturer's instruction about the applicable child's age and size.



! CAUTION

Ⓢ Never use a rear-facing child restraint system in the front seat because the force of the rapid inflation of the passenger airbag can cause severe injury to the child. Vehicles with a passenger airbag display a caution label on the passenger side instrument panel as shown above to remind you not to install a rear-facing child restraint system on the front seat.

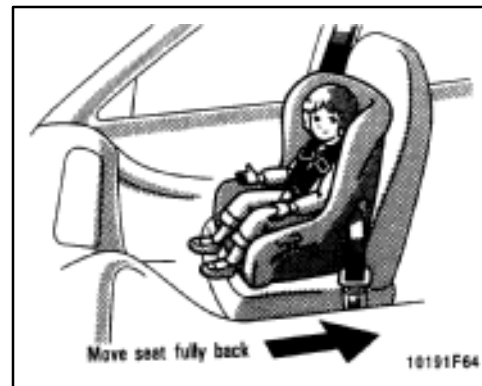

Ⓢ Only when it is unavoidable should a forward-facing child restraint system be used on the front seat. Always move the seat as far back as possible because the force of deploying airbag would cause serious injury to the child.

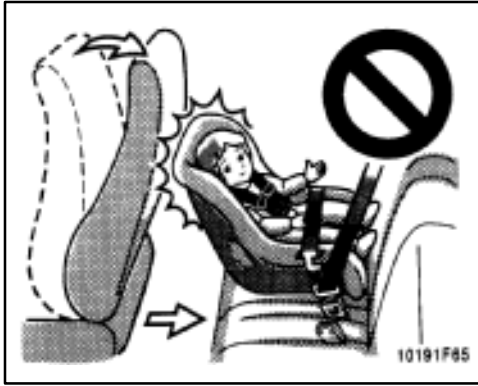

Ⓢ Do not use a rear-facing child restraint system in the rear seat if it interferes with the lock mechanism of the front seats. This can cause severe injury to the child and front passenger in case of sudden braking or a collision.



1. Run the lap and shoulder belt through or around the convertible seat following the instructions provided by its manufacturer and insert the tab into the buckle taking care not to twist the belt. Keep the lap portion of the belt tight.



- Ⓢ After inserting the tab, make sure the tab and buckle are locked and that the lap and shoulder portions of the belt is not twisted.
- Ⓢ Do not insert coins, clips, etc. in the buckle as this may prevent you from properly latching the tab and buckle.
- Ⓢ If the seat belt does not function normally, it cannot protect your child from injury. Contact your Toyota dealer immediately. Do not use the seat until the seat belt is fixed.

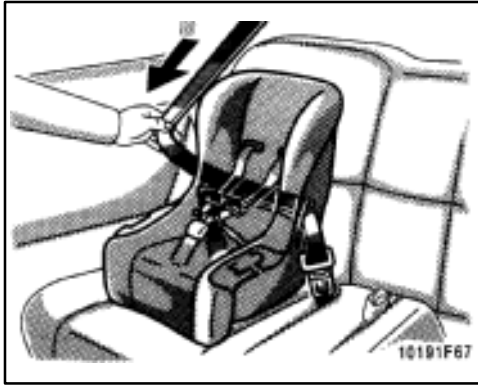

2. Fully extend the shoulder belt to put it in the lock mode. When the belt is then retracted even slightly, it cannot be extended.

To hold the convertible seat securely, make sure the belt is in the lock mode before letting the belt to retract.

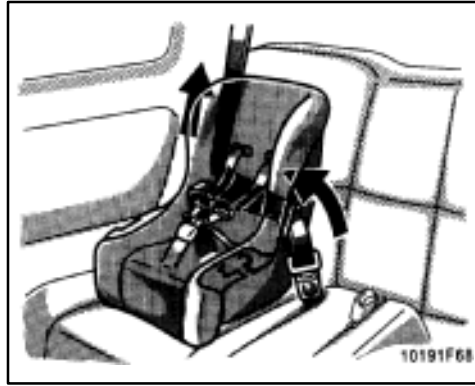

3. While pressing the convertible seat firmly against the seat cushion and seatback, let the shoulder belt retract as far as it will go to hold the convertible seat securely.



Make sure the seat belt is securely locked. Also make sure the child restraint system is secure by pushing and pulling it in different directions. Follow all the installation instructions provided by its manufacturer.

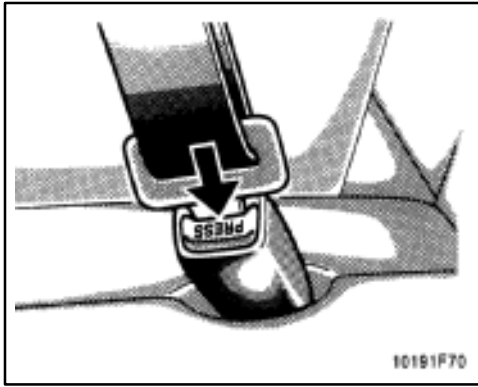

4. To remove the convertible seat, press the buckle–release button and allow the belt to retract completely. The belt will move freely again and be ready to work for an adult or older child passenger.

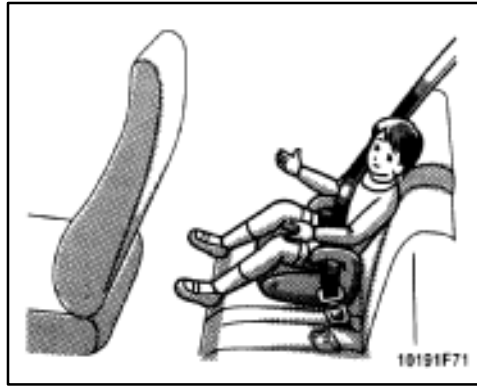

(C)BOOSTER SEAT INSTALLATION
A booster seat is used in forward-facing only.



! CAUTION

Only when it is unavoidable should a forward-facing child restraint system be used on the front seat. Always move the seat as far back as possible because the force of deploying airbag would cause serious injury to the child.



1. Sit the child on a booster seat. Run the lap and shoulder belt through or around the booster seat and child following the instructions provided by its manufacturer and insert the tab into the buckle taking care not to twist the belt.

Make sure the shoulder belt is correctly across the child's shoulder and that the lap belt is positioned as low as possible on child's hips. See "Seat belts" for details.

 **CAUTION**

- Ⓢ **Always make sure the shoulder belt is positioned across the center of child's shoulder. The belt should be kept away from child's neck, but not falling off child's shoulder. Failure to do so could reduce the amount of protection in an accident and increase the chance of injury.**
- Ⓢ **High-positioned lap belts and loose-fitting belts both could increase the chance of injury due to sliding under the lap belt during an accident. Keep the lap belt as low on your hip bone as possible.**
- Ⓢ **For the safety, do not place the shoulder belt under child's arm.**
- Ⓢ **After inserting the tab, make sure the tab and buckle are locked and that the lap and shoulder portions of the belt is not twisted.**
- Ⓢ **Do not insert coins, clips, etc. in the buckle as this may prevent you from properly latching the tab and buckle.**

Ⓢ If the seat belt does not function normally, it cannot protect your child from injury. Contact your Toyota dealer immediately. Do not use the seat until the seat belt is fixed.

—Top strap anchors and locations

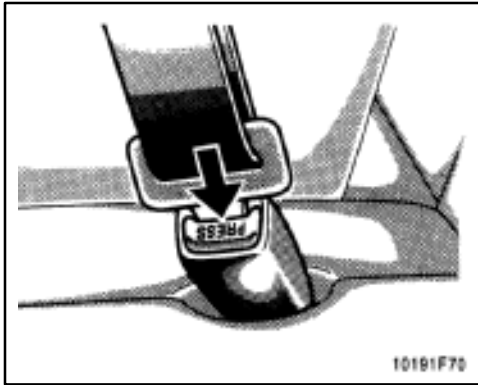

2. To remove the child restraint system, press the buckle–release button and allow the belt to retract.

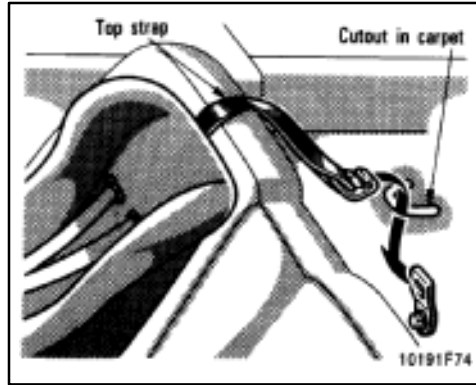

If your child restraint system requires the use of a top strap, latch the hood onto the anchor bracket and tighten the top strap.

Twist the top strap half a turn: make a twist at front top of the rear seatback, not behind it. Then pass the top strap through the cutout in the carpet on the rear cargo floor.

See the following instructions to install the anchor bracket.

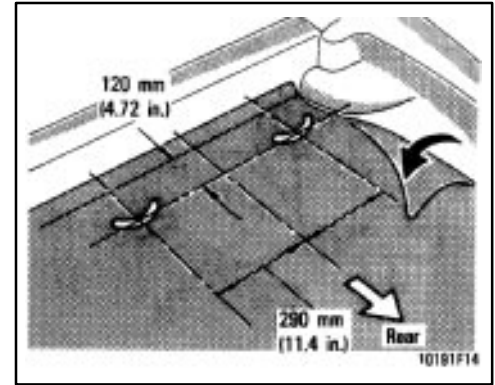

On the rear cargo floor

- a. Roll back the carpet on the rear cargo floor to find the anchor location you wish to use.
- b. Insert a 5 mm (0.5 in.) spacer and tighten down the anchor bracket for you child restraint system with a bolt. Torque the bolt to 16.5–24.7 N·m (1.68–2.52 kgf·m, 12.2–18.2 ft·lb.).

To make a cutout for the top strap passage, push open the carpet along the perforation with finger pressure. (The perforation can easily be seen from the back side of the carpet.)

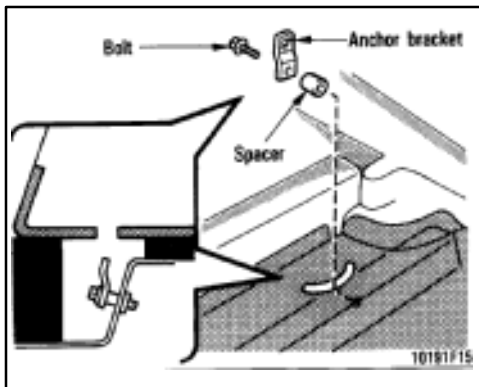

d. After installing the anchor, put the carpet back in place.

To comply with Canada Motor Vehicle Safety Standards, vehicles sold in Canada are provided with a bracket set in the glovebox, designed for use with any of the 3 anchor locations shown in the illustration.

If your child restraint system does not provide any of the necessary parts, ask your Toyota dealer. (See “—Child restraint system.”)

Tilt steering wheel

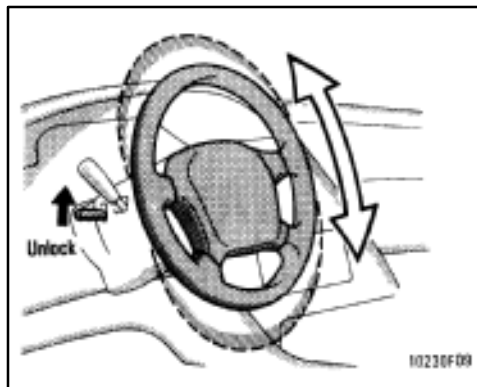

To change the steering wheel angle, hold the steering wheel, pull up the lock release lever, tilt the steering wheel to the desired angle and release the lever.

When the steering wheel is in a low position, it will spring up as you release the lock release lever.



Ⓢ **Do not adjust the steering wheel while the vehicle is moving.**

Ⓢ **After adjusting the steering wheel, try moving it up and down to make sure it is locked in position.**

Outside rear view mirrors—

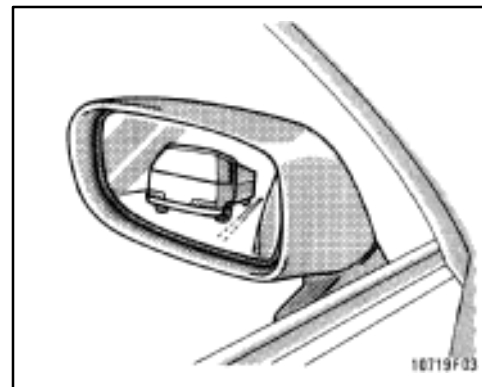

Adjust the mirror so you can just see the side of your vehicle in the mirror.

Be careful when judging the size or distance of any object seen in the outside rear view mirror on the passenger's side. It is a convex mirror with a curved surface. Any object seen in a convex mirror will look smaller and farther away than when seen in a flat mirror.

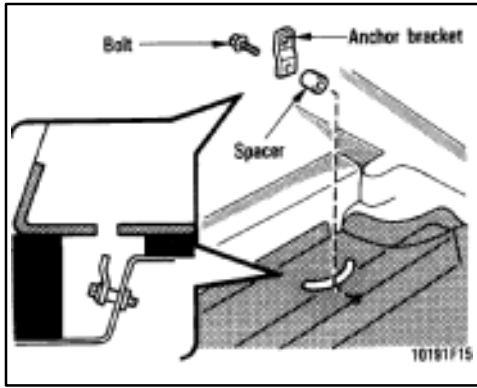

d. After installing the anchor, put the carpet back in place.

To comply with Canada Motor Vehicle Safety Standards, vehicles sold in Canada are provided with a bracket set in the glovebox, designed for use with any of the 3 anchor locations shown in the illustration.

If your child restraint system does not provide any of the necessary parts, ask your Toyota dealer. (See “—Child restraint system.”)

Tilt steering wheel

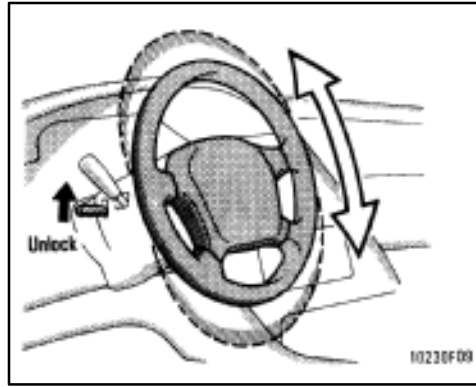

To change the steering wheel angle, hold the steering wheel, pull up the lock release lever, tilt the steering wheel to the desired angle and release the lever.

When the steering wheel is in a low position, it will spring up as you release the lock release lever.



Ⓢ Do not adjust the steering wheel while the vehicle is moving.

Ⓢ After adjusting the steering wheel, try moving it up and down to make sure it is locked in position.

Outside rear view mirrors—

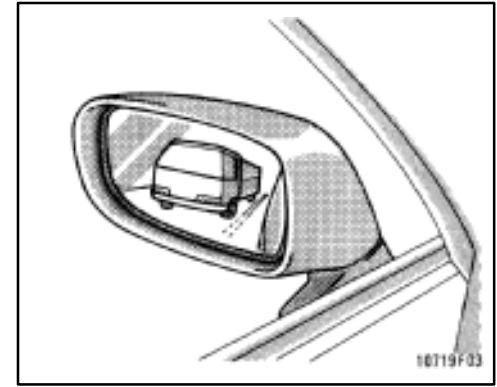

Adjust the mirror so you can just see the side of your vehicle in the mirror.

Be careful when judging the size or distance of any object seen in the outside rear view mirror on the passenger's side. It is a convex mirror with a curved surface. Any object seen in a convex mirror will look smaller and farther away than when seen in a flat mirror.

—Power rear view mirror control

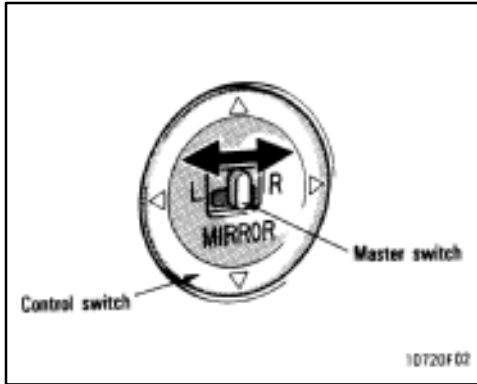

To adjust a power rear view mirror, first place the master switch at “L” (left) or “R” (right) depending on which mirror needs adjusting, then push the control switch in the desired direction.

If the engine is not running, the key must be in the “ACC” position.

NOTICE

If ice should jam the mirror, do not operate the control or scrape the mirror ice. Use a spray de-icer to free the mirror.

—Folding rear view mirrors

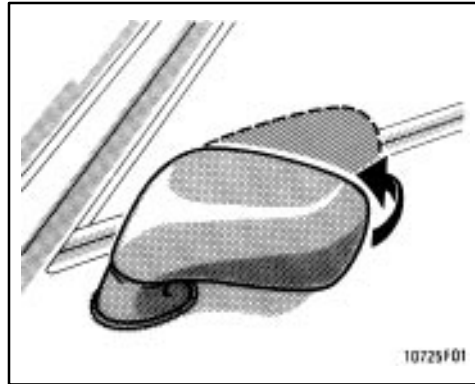

To fold the rear view mirror, push backward.

The rear view mirrors can be folded backward for parking in restricted areas.

Anti-glare inside rear view mirror

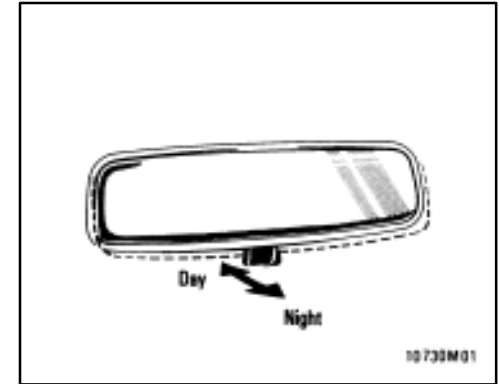

Pull the lever toward you to reduce glare from the headlights of the vehicle behind you during night driving.

Before adjusting the mirror to the position with most clarity, push the day-night change lever away from you (daylight driving position).

Remember that by reducing glare you also lose some rear view clarity.

Part 1

OPERATION OF INSTRUMENTS AND CONTROLS—

Chapter 1–4

Lights, Wipers and Defogger

- Ⓜ Headlights and turn signals
- Ⓜ Emergency flashers
- Ⓜ Instrument panel light control
- Ⓜ Front fog lights
- Ⓜ Interior lights
- Ⓜ Ignition switch light
- Ⓜ Luggage compartment light
- Ⓜ Windshield wipers and washer
- Ⓜ Rear window wiper and washer
- Ⓜ Rear window and outside rear view mirror defoggers

Headlights and turn signals

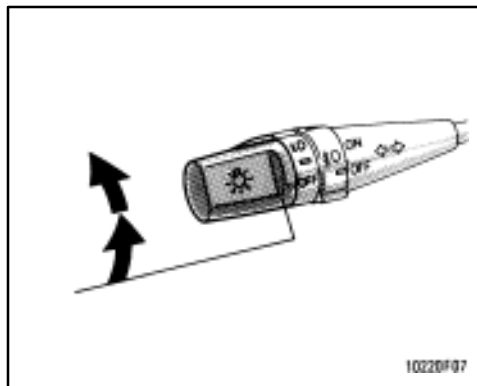

To turn the lights on, twist the knob on the end of the lever.

Daytime running light system (Canada only)—The headlights turn on when the parking brake is released with the engine started, even with the light switch in the “OFF” position. They will not go off until the ignition switch is turned off.

The turn on the other exterior lights and instrument panel lights, twist the knob to the first clickstop.

Under the daytime running light system, the headlights turn on at reduced intensity. Twist the knob to the second clickstop to turn to full intensity for driving at night.

FIRST CLICKSTOP: Only the parking, tail, license plate, side marker and instrument panel lights turn on.

SECOND CLICKSTOP: The headlights also turn on.

The lights automatically turn off when the driver’s door is opened with the ignition key turned off. To turn them on again, turn the key to the “ON” position or actuate the headlight switch. If you are going to park for over one week, make sure the headlight switch is off.

NOTICE

To prevent the battery from being discharged, do not leave the lights on for a long period when the engine is not running.

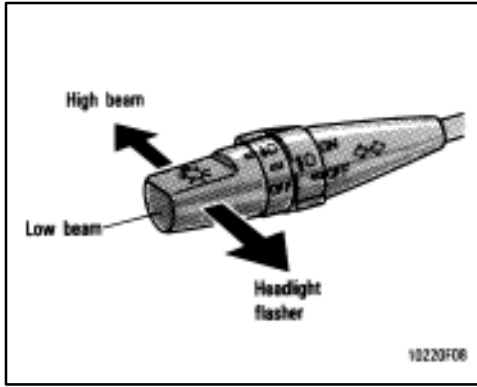

For high beam, push the lever away from you. Pull it toward you for low beam. For the headlight flasher, pull it further back.

A blue light in the instrument panel indicates high beam is on.

The headlight flasher works even when the headlight switch is off.

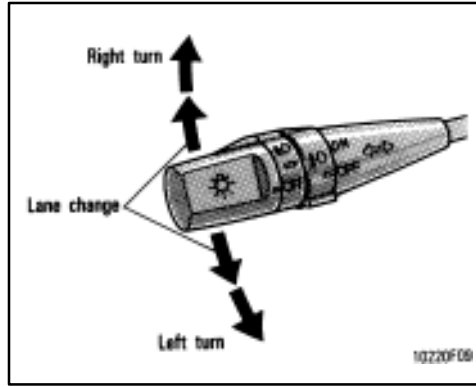

For signaling turns, move the lever up or down in the conventional manner.

The key must be in the “ON” position.

The turn signal is self-cancelling after a turn, but after a lane change, you may have to cancel it by hand. You can also signal a lane change by moving the turn signal lever partway and holding it there. If the green light in the instrument panel flashes faster than normal, it indicates that the front or rear turn signal bulb has burned out.

Emergency flashers

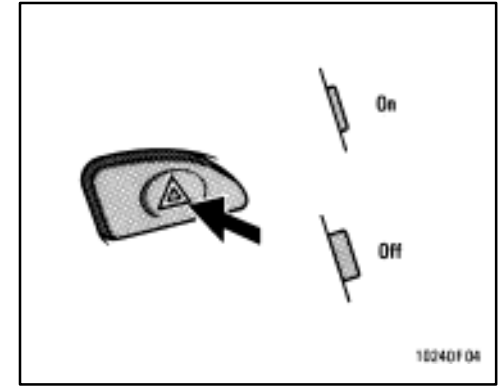

To turn on the emergency flashers, push the switch.

All the turn signal lights will flash.

Turn on the emergency flashers to warn other drivers if your vehicle must be stopped where it might be a traffic hazard. Always pull as far off the road as possible.

The turn signal light switch will not work when the emergency flashers are operating.

NOTICE

To prevent the battery from being discharged, do not leave the lights on for a long period when the engine is not running.

Instrument panel light control

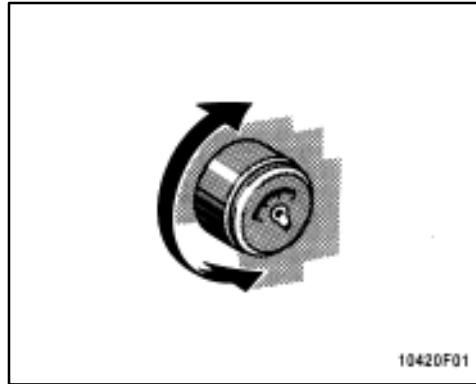

To adjust the brightness of the instrument panel lights, turn the knob.

Front fog lights

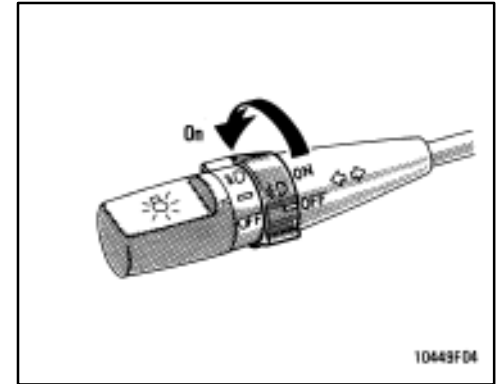

To turn on the front fog lights, twist the knob of the headlight and turn signal switch lever. They will come on when the headlights are turned on low beam.

Interior lights

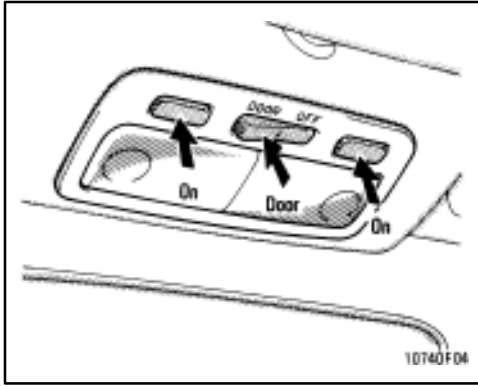

To turn on the interior light, slide the switch.

With the central switch pushed on the "DOOR" side, both lights come on when either of the side doors is opened. The lights remain on for a certain time after both doors are closed.

Ignition switch light

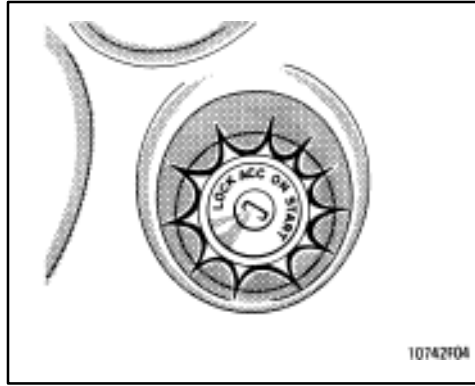

For easy access to the ignition switch, the ignition switch light comes on when either side door is opened.

The light remains on for a certain time after both side doors are closed.

Luggage compartment light

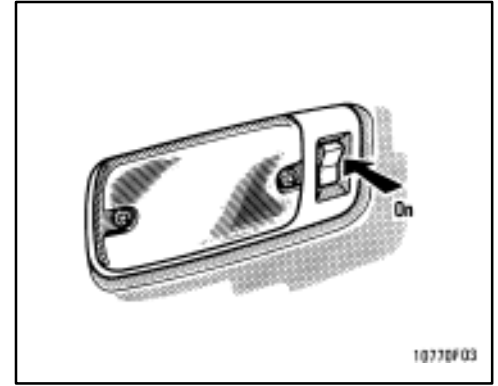

To turn the luggage compartment light on, open the back door and push the switch. Closing the back door will turn the light off.

Windshield wipers and washer

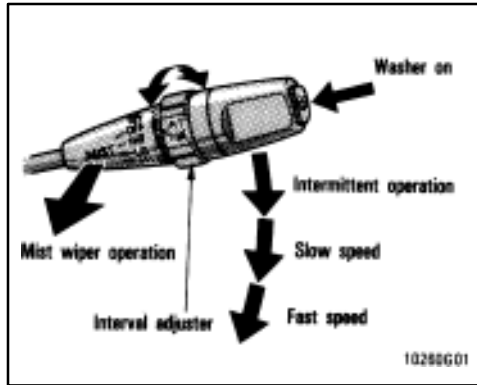

To turn the wipers on, move the lever. To make the washer squirt, push the button on the end of the lever.

The key must be in the "ON" position.

The wipers will operate at intervals when the lever is in the "INT" position. With the lever in this position, the wipers can be adjusted to operate at intervals of 3 to 12 seconds depending on the interval adjuster setting between "S" and "F".

If a single wipe is desired in mist, pull the lever toward you and release it.

Also, the wipers will automatically operate a couple of times after the washer squirts even with the lever in the "OFF" position.

If the washer does not work, check to see whether the washer tank is empty. For information on adding washer fluid, see "Adding washer fluid" in Chapter 7-3.

In cold weather, warm the windshield with the defroster before using the washer. This will help prevent icing, which could block your vision.

NOTICE

Do not operate the wipers if the windshield is dry. It may scratch the glass.

Rear window wiper and washer

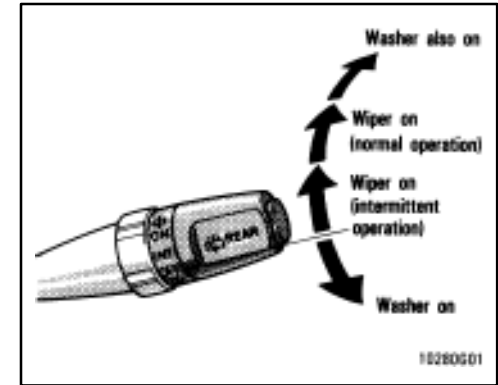

To turn the rear wiper and washer on, twist the knob at the end of the lever.

The key must be in the "ON" position.

The wiper will operate at intervals when the knob is in the "INT" position.

The washer squirts at the two marked knob positions. The knob will automatically return from these positions when it is released.

If the washer does not work, check to see whether the washer tank is empty. For information on adding washer fluid, see "Adding washer fluid" in Chapter 7-3.

NOTICE

Do not operate the wipers if the windshield is dry. It may scratch the glass.

Rear window and outside rear view mirror defoggers

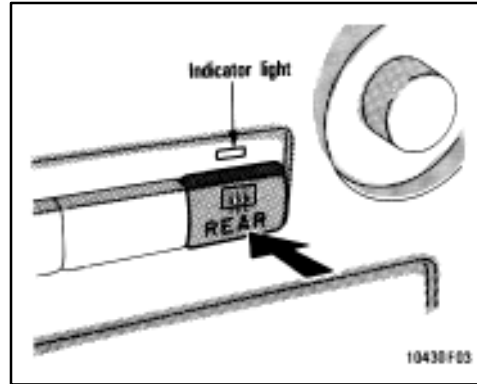

To defog or defrost the rear window, push the switch.

The key must be in the "ON" position.

The thin heater wires on the inside of the rear window will quickly clear the window surface. An indicator light will illuminate to indicate the defogger is operating.

On some models, the heater panels in the outside rear view mirrors will also quickly clear the surfaces. Keep your hands off the mirror faces when the switch is on.

Push the switch once again to turn the defogger off.

The system will automatically shut off after the defoggers have operated about 15 minutes.

Make sure you turn the defoggers off when the surfaces are clear. Leaving the defoggers on for a long time could cause the battery to discharge, especially during stop-and-go driving. The defoggers are not designed for drying rain water or for melting snow.

If the outside rear view mirrors are heavily coated with ice, use a spray de-icer before operating the switch.

NOTICE

When cleaning the inside of the rear window, be careful not to scratch or damage the heater wires.

Part 1

OPERATION OF INSTRUMENTS AND CONTROLS—

Chapter 1–5

Gauges, Meters and Service reminder indicators

- ® Fuel gauge
- ® Engine coolant temperature gauge
- ® Tachometer
- ® Odometer and two trip meters
- ® Service reminder indicators and warning buzzers

Fuel gauge

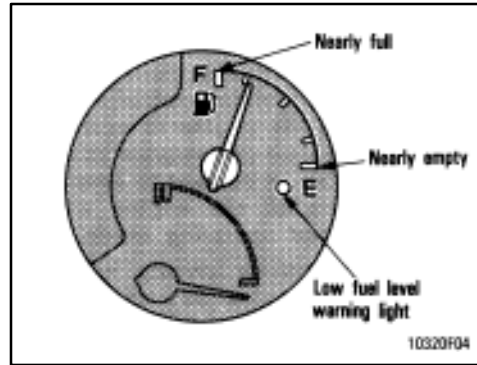

The gauge works when the ignition switch is on and indicates the approximate quantity of fuel remaining in the tank.

It is a good idea to keep the tank over 1/4 full.

This fuel gauge has a non–return type needle which remains at the last indicated position when the ignition switch is turned off.

If the level approaches “E” or the low fuel level warning light comes on, fill the fuel tank as soon as possible.

If the fuel tank is completely empty, the malfunction indicator lamp comes on. Fill the fuel tank immediately.

The indicator lamp goes off after driving several times. If the indicator lamp does not go off, contact your Toyota dealer as soon as possible.

Engine coolant temperature gauge

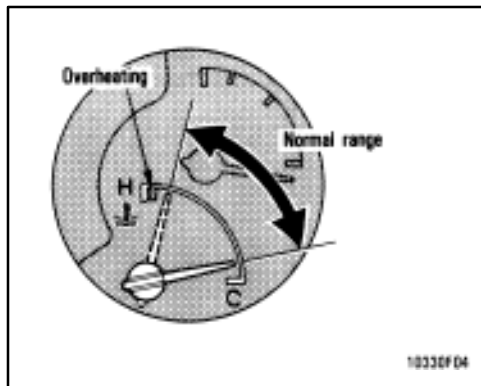

The gauge indicates the engine coolant temperature when the ignition switch is on. The engine operating temperature will vary with changes in weather and engine load.

If the needle points to the red zone or higher, stop your vehicle and allow the engine to cool.

Your vehicle may overheat during severe operating conditions, such as:

- Ⓡ Driving up a long hill on a hot day.
- Ⓡ Reducing speed or stopping after high speed driving.
- Ⓡ Idling for a long period with the air conditioning on in stop-and-go traffic.

NOTICE

◀ **Do not remove the thermostat in the engine cooling system as this may cause the engine to overheat. The thermostat is designed to control the flow of coolant to keep the temperature of the engine within the specified operating range.**

◀ **Do not continue driving with an overheated engine. See “If your vehicle overheats” in Part 4.**

Tachometer

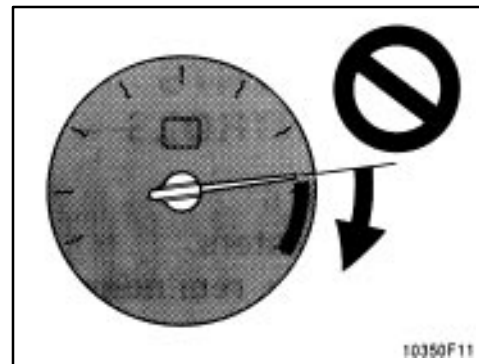

The tachometer indicates engine speed in thousands of rpm (revolutions per minute). Use it while driving to select correct shift points and to prevent engine lugging and overrevving.

Driving with the engine running too fast causes excessive engine wear and poor fuel economy. Remember, in most cases the slower the engine speed, the greater the fuel economy.

NOTICE

Do not let the indicator needle get into the red zone. This may cause severe engine damage.

Odometer and two trip meters

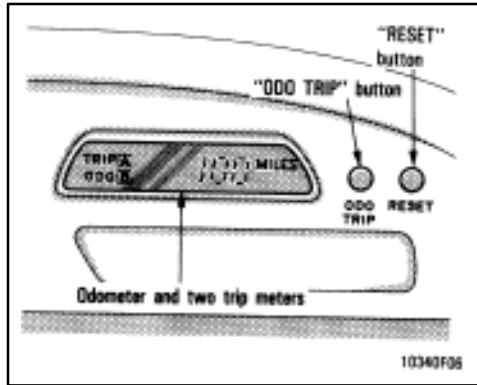





This meter displays the odometer and two trip meters. To change the odometer display to the trip meter display, push the “ODO TRIP” button. To reset the trip meter A to zero, display the meter A reading, then push the “RESET” button. The same applies for the trip meter B.





The odometer records the total distance the vehicle has been driven. The trip meters can record two different distances independently.

You can use one trip meter to calculate the fuel economy and the other to measure the distance on each trip. All trip meter data is cancelled if the electrical power source is disconnected.

The meter display changes each time you push the “ODO TRIP” button, changing in order from the odometer to trip meter A to trip meter B, then back to the odometer.

Service reminder indicators and warning buzzers

If the indicator or buzzer comes on...	Do this.
(a) 	Stop and check.
(b) BRAKE (type A)	If parking brake is off, stop and check.
 (type B)	
(c)  (Indicator and buzzer)	Fasten seat belts.
(d) 	Stop and check.
(e)  CHECK	Take vehicle to Toyota dealer.

If the indicator or buzzer comes on...	Do this.
(f) Low fuel level warning light	Fill up tank.
(g) 	Stop and check.
(h) 	Add engine oil.
(i) ABS (type A)	Take vehicle to Toyota dealer.
 (type B)	
(j) 	Close both side door and back door.
(k) 	Replace bulb.

If the indicator or buzzer comes on...	Do this.
(l) 	Take vehicle to Toyota dealer immediately.
(m) TRAC OFF	Take vehicle to Toyota dealer.
(n) Key reminder buzzer	Remove key.

(a) Master Warning Light

This light warns that another service reminder indicator (except seat belt reminder light, low fuel level warning lights, rear light failure warning light, SRS airbag warning light and “TRAC OFF” indicator/warning light) is on.

If it comes on while you are driving, check the other service reminder indicator that is on with reference to the following description of the indicator.

(b) Brake System Warning Light

This light has the following functions:

Parking brake reminder

If this light is on, make sure the parking brake is fully released. The light should go off.

Low brake fluid level warning

If this light comes on and stays on while you are driving, slow down and pull off the road. Then stop the vehicle carefully. There maybe a problem somewhere in the brake system. Check the fluid level of the see-through reservoir.

To make sure the parking brake has not caused the warning light to come on, check to see that the parking brake is fully released.

If the brake fluid level is low...

At a safe place, test your brakes by starting and stopping.

- ® If you judge that the brakes still work adequately, drive cautiously to your nearest dealer or shop for repairs.
- ® If the brakes are not working, have the vehicle towed in for repairs. (For towing information, see Part 4.)



CAUTION

It is dangerous to continue driving normally when the brake fluid level is low.

If the brake fluid level is correct...

Have the warning system checked by your Toyota dealer.

(c) Seat Belt Reminder Light and Buzzer

Once the ignition key is turned to “ON” or “START”, the reminder light and buzzer come on if the driver’s seat belt is not fastened. Unless the driver fastens the belt, the light stays on and the buzzer stops after about 4 to 8 seconds.

(d) Discharge Warning Light

This light warns that the battery is being discharged.

If it comes on while you are driving, there is a problem somewhere in the charging system.

The engine ignition will continue to operate, however, until the battery is discharged. Turn off the air conditioning, blower, radio, etc., and drive directly to the nearest Toyota dealer or repair shop.

NOTICE

Do not continue driving if the engine drive belt is broken or loose.

(e) Malfunction Indicator Lamp

This lamp comes on in the following cases.

- a. The fuel tank is completely empty. (See “Fuel gauge” in Chapter 1–5 for instructions.)
- b. There is a problem somewhere in your engine or automatic transmission electrical system.

If it comes on while you are driving in case b, have your vehicle checked/repaired by your Toyota dealer as soon as possible.

(f) Low Fuel Pressure Warning Light

This light comes on when the fuel level in the tank becomes nearly empty. Fill up the tank as soon as possible.

(g) Low Oil Level Warning Light

This light warns that the engine oil pressure is too low.

If it flickers or stays on while you are driving, pull off the road to a safe place and stop the engine immediately. Call a Toyota dealer or qualified repair shop for assistance.

The light may occasionally flicker when the engine is idling or it may come on briefly after a hard stop. There is no cause for concern if it then goes out when the engine is accelerated slightly.

The light may come on when the oil level is extremely low. It is not designed to indicate low oil level, and the oil level must be checked using the level dipstick.

NOTICE

Do not drive the vehicle with the warning light on—even for one block. It may ruin the engine.

(h) Low Engine Oil Level Warning Light

The light warns that the engine oil level is too low. Add oil as soon as possible. (For instructions, see “Checking the engine oil level” in Chapter 7–2.)

NOTICE

Continued engine operation with low engine oil will damage the engine.

(i) “ABS” Warning Light

This light warns that there is a problem somewhere in your anti-lock brake system.

If the light comes on while you are driving, have your vehicle checked by your Toyota dealer as soon as possible.

The light will come on when the ignition key is turned to the “ON” position. After about 3 seconds, the light will go off.

When the “ABS” warning light is on (and the brake system warning light is off), the brake system operates conventionally but anti-lock brake system is not assisting brake performance so that the wheels can lock-up during sudden braking or braking on slippery road surfaces.

(j) Open Door Warning Light

This light remains on until both side doors and back door are completely closed.

(k) Rear Light Failure Warning Light

If this light comes on when the headlight switch is turned on (at the first or second clickstop), it indicates that one or more of the tail lights are burned out.

If it comes on when the brake pedal is depressed, one or more stop lights are burned out or the stop light circuit is in need of repair.

Have defective bulbs replaced as soon as possible.

(l) SRS Airbag Warning Light

This light will come on when the ignition key is turned to the “ACC” or “ON” position. After about 6 seconds, the light will go off. This means the airbag system is operating properly.

The warning light system monitors the airbag sensors, center airbag sensor assembly, inflators, warning light, interconnecting wiring and power sources.

If either of the following conditions occurs, this indicates a malfunction somewhere in the parts monitored by the warning light system. Contact your Toyota dealer as soon as possible to service the vehicle.

Ⓡ The light does not come on when the ignition key is turned to the “ACC” or “ON” position or remains on.

Ⓡ The light comes on while driving.

(m) “TRAC OFF” Indicator/Warning Light

This light comes on when the ignition key is turned to “N”, and will go off after 3 seconds. This means that the system is operating properly.

If one of the following conditions occurs, this indicates a malfunction somewhere in the parts monitored by the warning light system. Contact your Toyota dealer as soon as possible to service the vehicle.

Ⓡ The light remains on more than 3 seconds after the ignition switch is turned on.

Ⓡ The light comes on while driving even if the “TRAC OFF” switch is not pushed.

Ⓡ The light flashes.

(n) Key Reminder Buzzer

This buzzer reminds you to remove the key when you open the driver’s door with the ignition key in the “ACC” or “LOCK” position.

CHECKING SERVICE REMINDER INDICATORS (except the low fuel level warning light)

1. Apply the parking brake.
2. Open one of the side doors or the back door.
The open door warning light should come on.
3. Close the door.
The open door warning light should go off.
4. Turn the ignition key to “ACC”.
The SRS airbag warning light should come on. It goes off after about 6 seconds.
5. Turn the ignition key to “ON”, but do not start the engine.

All the service reminder indicators except the open door warning light and SRS airbag warning light should come on. The “ABS” warning light and “TRAC OFF” indicator/warning light go off after about 3 seconds.

If any service reminder indicator or warning buzzer does not function as described above, either the bulb is burned out or the circuit is in need of repair. Have it checked by your Toyota dealer as soon as possible.

Part 1

OPERATION OF INSTRUMENTS AND CONTROLS—

Chapter 1–6

Ignition switch, Transmission and Parking brake

- Ⓡ Ignition switch with steering lock
- Ⓡ Automatic transmission
- Ⓡ Manual transmission
- Ⓡ Parking brake
- Ⓡ Cruise control

Ignition switch with steering lock

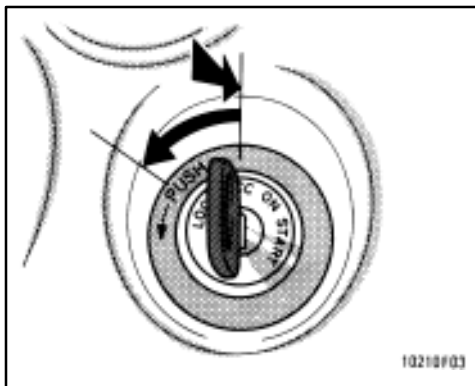

“Start” – Starter motor on. The key will return to the “ON” position when released.

For starting tips, see Part 3.

“ON” – Engine on and all accessories on.

This is the normal driving position.

“ACC” – Accessories such as the radio operate, but the engine is off.

If you leave the key in the “ACC” or “LOCK” position and open the driver’s door, a buzzer will remind you to remove the key.

“LOCK” – Engine is off and the steering wheel is locked. The key can be removed only at this position.

You must push in the key to turn the key from “ACC” to the “LOCK” position. On vehicles with an automatic transmission, the selector lever must be put in the “P” position before pushing the key.

When starting the engine, the key may seem stuck at the “LOCK” position. To free it, first be sure the key is pushed all the way in, and then rock the steering wheel slightly while turning the key gently.



CAUTION

For manual transmission:
Never remove the key when the vehicle is moving, as this will lock the steering wheel and result in loss of steering control.

NOTICE

Do not leave the key in the “ON” position if the engine is not running. The battery will discharge and the ignition could be damaged.

Automatic transmission

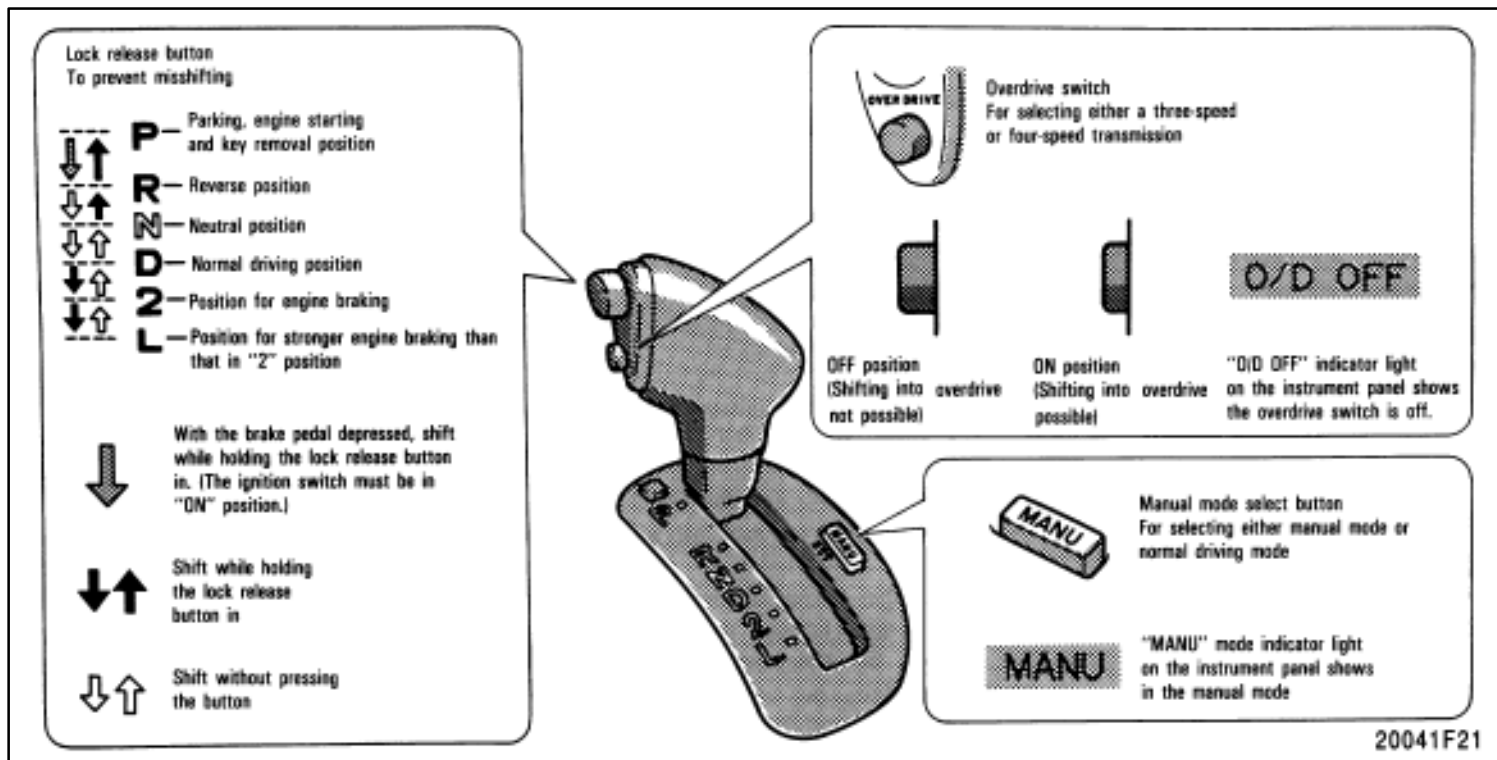

When the cruise control is being used, even if you downshift the transmission by turning off the overdrive switch, engine braking will not be applied because the cruise control is not cancelled. For ways to decrease the vehicle speed, see "Cruise control" in this chapter.

Your automatic transmission has a shift lock system to minimize the possibility of incorrect operation. This means you can only shift out of “P” position when the brake pedal is depressed (with the ignition switch in “ON” position and the lock release button depressed).

(a) Normal Driving

1. Start the engine as instructed in “How to start the engine” in Part 3. The transmission must be in “P” or “N”.
2. With your foot holding down the brake pedal, shift the selector lever to “D”.

In “D” position, the automatic transmission system will select the most suitable gear for running conditions such as normal cruising, hill climbing, hard towing, etc.

Always turn the overdrive switch on for better fuel economy and quieter driving. If the engine coolant temperature is low, the transmission will not shift into overdrive gear even with the overdrive switch on.



Never put your foot on the accelerator pedal while shifting.

3. Release the parking brake and brake pedal. Depress the accelerator pedal slowly for smooth starting.

(b) Using engine braking

To use engine braking, you can downshift the transmission as follows:

- ® Turn off the overdrive switch. The “O/D OFF” indicator light will come on and the transmission will downshift to the third gear.
- ® Shift into the “2” position. The transmission will downshift to the second gear when the vehicle speed drops down to or lower than the following speed, and more powerful engine braking will be obtained.

2JZ–GE engine 115 km/h (72 mph)
2JZ–GTE engine 130 km/h (81 mph)

- ® Shift into the “L” position. The transmission will downshift to the first gear when the vehicle speed drops down to or lower than the following speed, and maximum engine braking will be applied.

2JZ–GE engine 48 km/h (29 mph)
2JZ–GTE engine 60 km/h (37 mph)

When the cruise control is being used, even if you downshift the transmission by turning off the overdrive switch, engine braking will not be applied because the cruise control is not cancelled. For ways to decrease the vehicle speed, see “Cruise control” in this chapter.



Be careful when downshifting on a slippery surface. Abrupt shifting could cause the vehicle to spin or skid.

(c) Using the “2” and “L” positions

The “2” and “L” positions are used for strong engine braking as described previously.

With the selector lever in “2” or “L”, you can start the vehicle in motion as with the lever in “D”.

With the selector lever in “2”, the vehicle will start in the first gear and automatically shift to the second gear.

With the selector lever in “L”, the transmission is engaged in the first gear.

NOTICE

◀Be careful not to overrev the engine. Watch the tachometer to keep engine rpm from going into the red zone. The approximate maximum allowable speed for each position is given below for your reference:

2JZ-GE

“2” 115 km/h (72 mph)

“L” 63 km/h (39 mph)

2JZ-GTE engine

“2” 130 km/h (81 mph)

“L” 70 km/h (44 mph)

◀Do not continue hill climbing or hard towing for a long time in the “2” or “L” position. This may cause severe automatic transmission damage from overheating. To prevent such damage, “D” position should be used in hill climbing or hard towing.

(d) Backing up

1. Bring the vehicle to a complete stop.
2. With the brake pedal held down with your foot, shift the selector lever to the “R” position.

NOTICE

Never shift into reverse while the vehicle is moving.

(e) Parking

1. Bring the vehicle to a complete stop.
2. Pull the parking brake lever up fully to securely apply the parking brake.
3. With the brake pedal pressed down, shift the selector lever to the “P” position.



While the vehicle is moving, never attempt to move the selector lever into “P” position under any circumstances. Serious mechanical damage and loss of vehicle control may result.

(f) Good driving practice

If the transmission is repeatedly upshifted and downshifted between third gear and overdrive when climbing a gentle slope, the overdrive switch should be turned off. Be sure to turn the switch on immediately afterward.



Always keep your foot on the brake pedal while stopped with the engine running. This prevents the vehicle from creeping.

NOTICE

Do not hold the vehicle on an upgrade with the accelerator pedal. It can cause the transmission to overheat. Always use the brake pedal or parking brake.

(g) Rocking your vehicle if stuck



If you rock your vehicle to make it out when it becomes stuck in snow, mud, sand, etc., first check that there is no physical object or people around the vehicle. During operation the vehicle may suddenly move forward or backward, causing injury or damage to nearby people or objects.

NOTICE

If you rock your vehicle, observe the following precautions to prevent damage to the transmission and other parts.

◀ ***Do not depress the accelerator pedal while shifting the selector lever or before the transmission is completely shifted to forward or reverse gear.***

◀ ***Do not race the engine and avoid spinning the wheels.***

◀ ***If your vehicle remains stuck after rocking the vehicle several times, consider other ways such as towing.***

(h) Driving in manual mode

In the manual mode, the transmission system stops automatic gear shifting. Use this mode when starting your vehicle on a snowy or slippery road, when driving up steep inclines, and down with engine braking.

To set the manual mode, push the “MANU” button. In the manual mode, the “MANU” mode indicator light comes on and the transmission shifts up or down as follows.

Manual transmission

“D” position—The transmission is locked in third gear.

When your vehicle speed drops down, the transmission will shift to second gear for smooth accelerating.

“2” position—The transmission is locked in second gear.

“L” position—The transmission is locked in first gear.

NOTICE

Be careful not to overrev the engine when using “2” or “L” position.

If the automatic transmission fluid temperature becomes too high, the “MANU” mode indicator light flashes for several seconds and goes off. The driving mode then automatically changes from manual mode to the normal driving mode.

To cancel the manual mode, push the “MANU” button once again. The “MANU” mode indicator light will go off and the transmission system will work in the normal driving mode.

The manual mode automatically cancels out when the ignition switch is off.

(i) If you cannot shift the selector lever out of “P” position

If you cannot shift the selector lever from the “P” position even though the brake pedal is depressed, use the shift lock override button. For instructions, see “If you cannot shift automatic transmission selector lever” in Part 4.

Manual transmission (5-speed)

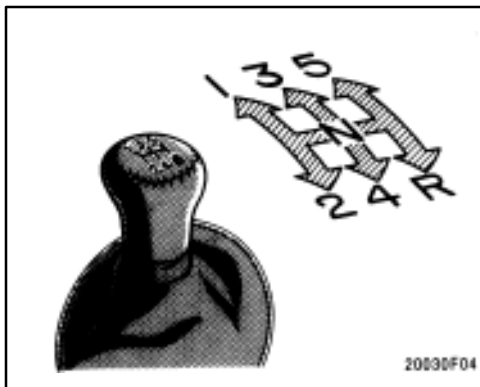

The shift pattern is conventional as shown above.

Press the clutch pedal down fully while shifting, and then release it slowly. Do not rest your foot on the pedal while driving, because it will cause clutch trouble. And do not use the clutch to hold the vehicle when stopped on an uphill grade—use the parking brake.

Recommended shifting speeds

The transmission is fully synchronized and upshifting or downshifting is easy.

For the best compromise between fuel economy and vehicle performance, you should upshift or downshift at the following speeds:

Gear	km/h (mph)
1 to 2 or 2 to 1	24 (15)
2 to 3 or 3 to 2	40 (25)
3 to 4 or 4 to 3	64 (40)
4 to 5 or 5 to 4	72 (45)

Upshifting too soon or downshifting too late will cause lugging, and possibly ping-pong. Regularly revving the engine to maximum speed in each gear will cause excessive engine wear and high fuel consumption.

Maximum allowable speeds

To get on a highway or to pass slower traffic, maximum acceleration may be necessary. Make sure you observe the following maximum allowable speeds in each gear:

gear	km/h (mph)
1	54 (34)
2	94 (59)
3	139 (87)

NOTICE

Do not downshift if you are going faster than the maximum allowable speed for the next lower gear.

Good driving practice

If it is difficult to shift into reverse, put the transmission in neutral, release the clutch pedal momentarily, and then try again.



CAUTION

Be careful when downshifting on a slippery surface. Abrupt shifting could cause the vehicle to spin or skid.

NOTICE

Make sure the vehicle is completely stopped before shifting into reverse.

Manual transmission (6-speed)

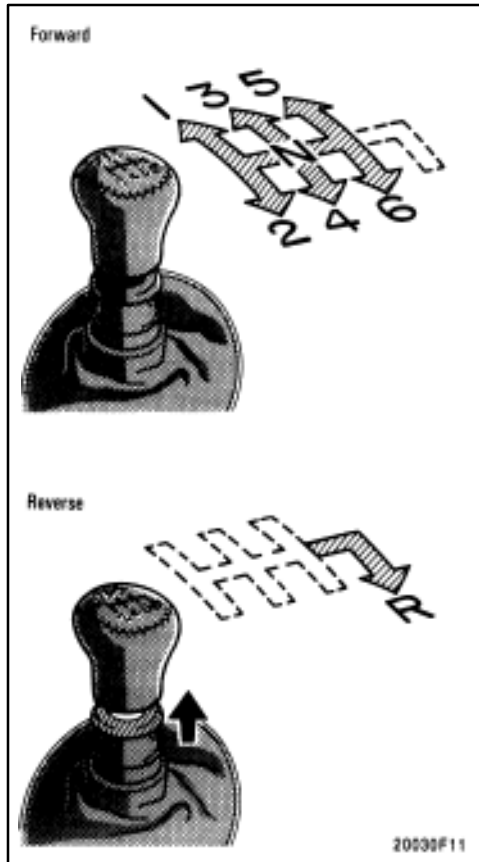

The shift pattern is shown above. You must lift up the ring around the gear shift lever to shift into “R” (reverse).

Press the clutch pedal down fully while shifting, and then release it slowly. Do not rest your foot on the pedal while driving, because it will cause clutch trouble. And do not use the clutch to hold the vehicle when stopped on an uphill grade—use the parking brake.

Recommended shifting speeds

The transmission is fully synchronized and upshifting or downshifting is easy. For the best compromise between fuel economy and vehicle performance, you should upshift or downshift at approximately the following speeds:

gear	km/h (mph)
1 to 2 or 2 to 1	54 (34)
2 to 3 or 3 to 2	40 (25)
3 to 4 or 4 to 3	64 (40)
4 to 5 or 5 to 4	72 (45)
5 to 6 or 6 to 5	80 (50)

Upshifting too soon or downshifting too late will cause lugging, and possibly ping-pong. Regularly revving the engine to maximum speed in each gear will cause excessive engine wear and high fuel consumption.

Maximum allowable speeds

To get on a highway or to pass slower traffic, maximum acceleration may be necessary. Make sure you observe the following maximum allowable speeds in each gear:

gear	km/h (mph)
1	60 (38)
2	97 (61)
3	136 (85)
4	175 (109)

NOTICE

Do not downshift if you are going faster than the maximum allowable speed for the next lower gear.

Good driving practice

If it is difficult to shift into reverse, put the transmission in neutral, release the clutch pedal momentarily, and then try again.



CAUTION

Be careful when downshifting on a slippery surface. Abrupt shifting could cause the vehicle to spin or skid.

NOTICE

Make sure the vehicle is completely stopped before shifting into reverse.

Parking brake

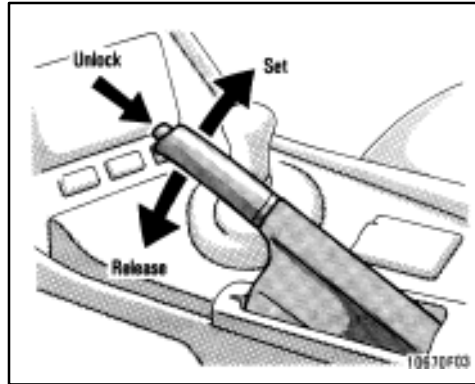

To set: Pull up the lever.

To release: Pull up slightly, press the thumb button, and lower.

Before leaving your vehicle, firmly apply the parking brake. For better holding power, first depress the brake pedal and hold it while setting the parking brake.



CAUTION

Before driving, be sure the parking brake is fully released and the parking brake reminder light is off.

Cruise control

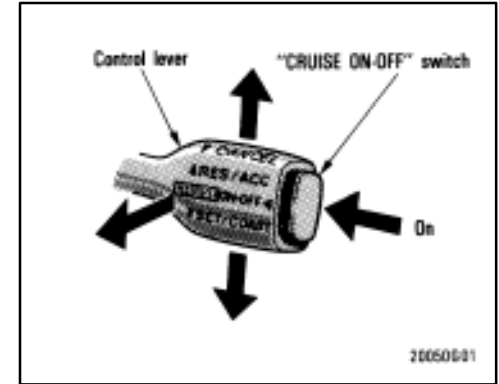

The cruise control allows you to cruise the vehicle at a desired speed over 40 km/h (25 mph) even with your foot off the accelerator pedal.

Your cruising speed can be maintained up or down grades within the limits of engine performance, although a slight speed change may occur when driving up or down the grades. On steeper hills, a greater speed change will occur so it is better to drive without the cruise control.



CAUTION

®To help maintain maximum control of your vehicle, do not use the cruise control when driving in heavy or varying traffic, or in slippery (rainy, icy or snow-covered) or winding roads.

®Avoid vehicle speed increases when driving downhill. If the vehicle speed is too fast in relation to the cruise control set speed, cancel the cruise control then downshift the transmission to use engine braking to slow down.

TURNING ON THE SYSTEM

To operate the cruise control, push the “CRUISE ON–OFF” switch. This turns the system on. The indicator light in the instrument panel shows that you can now set the vehicle at a desired cruising speed. Another push will turn the system completely off.



CAUTION

To avoid accidental cruise control engagement, keep the “CRUISE ON–OFF” switch off when not using the cruise control.

SETTING AT A DESIRED SPEED

On vehicles with automatic transmission, the transmission must be in “D” before you set the cruise control speed.

Bring your vehicle to the desired speed, push the lever down in the “SET/COAST” direction and release it. This sets the vehicle at that speed. If the speed is not satisfactory, tap it down for a slower speed. Each tap changes the set speed by 1.6 km/h (1.0 mph). You can now take your foot off the accelerator pedal.

If you need acceleration — for example, when passing—depress the accelerator pedal enough for the vehicle to exceed the set speed. When you release it, the vehicle will return to the speed set prior to the acceleration.



CAUTION

For manual transmission:
While driving with the cruise control on, do not shift to neutral without depressing the clutch pedal, as this may cause engine racing or overrevving.

CANCELLING THE PRESET SPEED

You can cancel the preset speed by:

- Pulling the lever in the “CANCEL” direction and releasing it.
- Depressing the brake pedal.
- Depressing the clutch pedal (manual transmission).

If the vehicle speed falls below about 40 km/h (25 mph), the preset speed will automatically cancel out.

If the vehicle speed drops 16 km/h (10 mph) below the preset speed, the preset speed will also automatically cancel out.

If the preset speed automatically cancels out other than for the above cases have your vehicle checked by your Toyota dealer at the earliest opportunity.

RESETTING AT A FASTER SPEED

Press the control lever upward in the “RES/ACC” direction and hold it. Release the lever when the desired speed is attained. While the lever is held up, the vehicle will gradually gain speed.

However, a faster way to reset is to accelerate the vehicle and then push the lever down in the “SET/COAST” direction.

RESETTING AT A SLOWER SPEED

Push the control lever down in the “SET/COAST” direction and hold it. Release the lever when the desired speed is attained. While the lever is held down, the vehicle speed will gradually decrease.

However, a faster way to reset is to depress the brake pedal and then push the lever down in the “SET/COAST” direction.

RESUMING THE PRESET SPEED

If the preset speed is cancelled by pulling the control lever or by depressing the brake pedal or clutch pedal, pushing the lever up in the “RES/ACC” direction will restore the speed set prior to cancellation.

However, once the vehicle speed falls below about 40 km/h (25 mph), the preset speed will not be resumed.

CRUISE CONTROL FAILURE WARNING

If the “CRUISE” indicator light in the instrument cluster flashes when using the cruise control, press the “CRUISE ON–OFF” button to turn the system off and then press it again to turn it on.

If any of the following conditions then occurs, there is some trouble in the cruise control system.

- ® The indicator light does not come on.
- ® The indicator light flashes again.
- ® The indicator light goes out after it comes on.

If this is the case, contact your Toyota dealer and have your vehicle inspected.

Part 1

OPERATION OF INSTRUMENTS AND CONTROLS—

Chapter 1–7

Car audio system and Air conditioning system

Car audio system

Reference

Using your audio system: some basics

Using your audio system: controls and features

Anti-theft system

Car audio system operating hints

Air conditioning system

Controls

Air flow selector settings

Operating tips

Instrument panel vents

Car audio system— —Reference

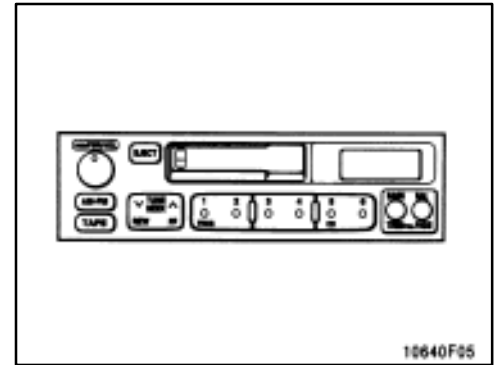

Type 1–1: AM-FM ETR radio/cassette player

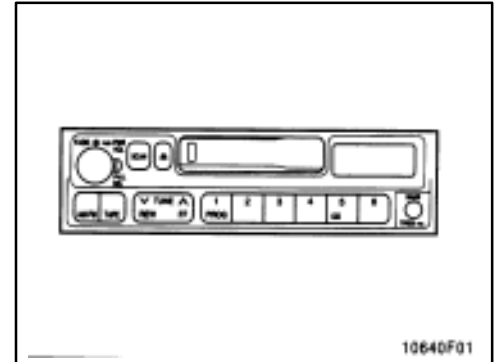

Type 1–2: AM-FM ETR radio/cassette player

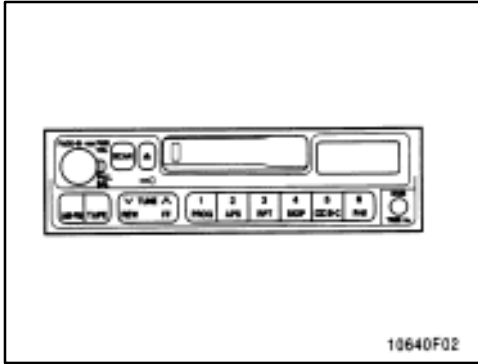

Type 1-3: AM-FM ETR radio/cassette player



Type 2: AM-FM ETR radio/cassette player/compact disc player

—Using your audio system: some basics

This section describes some of the basic features on Toyota audio systems. Some information may not pertain to your system.

Your audio system works when the ignition key is in the “ACC” or “ON” position.

TURNING THE SYSTEM ON AND OFF

Push “PWR · VOL” or “PWR/VOL” to turn the audio system on and off.

Push “AM · FM”, “TAPE” or “CD” to turn on that function without pushing “PWR · VOL” or “PWR/VOL”.

You can turn on the cassette player by inserting a cassette tape.

You can turn off the cassette player by ejecting the cassette tape. If the audio system was previously off, then the entire audio system will be turned off when you eject the cassette tape. If the radio was previously on, it will come on again.

SWITCHING BETWEEN FUNCTIONS

Push “AM · FM”, “TAPE” or “CD” if the system is already on but you want to switch from one function to another.

TONE AND BALANCE

For details about your system’s tone and balance controls, see the description of your own system.

Tone

How good an audio program sounds to you is largely determined by the mix of the treble, midrange, and bass levels. In fact, different kinds of music and vocal programs usually sound better with different mixes of treble, midrange, and bass.

Balance

A good balance of the left and right stereo channels and of the front and rear sound levels is also important.

Keep in mind that if you are listening to a stereo recording or broadcast, changing the right/left balance will increase the volume of one group of sounds while decreasing the volume of another.

YOUR RADIO ANTENNA

To lower a manual antenna, carefully push it down.

To lower a power antenna, turn off the audio system by pushing “PWR · VOL” or “PWR/VOL”, or turn the ignition key to “LOCK”.

On some models, the power antenna automatically retracts when the radio mode is switched off to turn on the cassette tape player or compact disc player.

NOTICE

To prevent damage to the antenna, make sure it is retracted before driving your Toyota through an automatic car wash.

YOUR CASSETTE PLAYER

When you insert a cassette, the exposed tape should be to the right.

NOTICE

Do not oil any part of the player and do not insert anything other than cassette tapes into the slot, or the tape player may be damaged.

YOUR COMPACT DISC PLAYER

When you insert a disc, gently push it in with the label side up. (The player will automatically eject a disc if the label side is down.) The compact disc player will play from track 1 through the end of the disc. Then it will play from track 1 again.

NOTICE

Never try to disassemble or oil any part of the compact disc player. Do not insert anything except a compact disc into the slot.

8 cm (3 in.) compact disc singles

Your compact disc player does not need an adaptor to play compact disc singles. Compact disc singles are about 8 cm (3 in.) in diameter—smaller than standard discs.

After you eject a compact disc single, do not insert a standard 12 cm (5 in.) disc until “DISC” disappears from the display.

NOTICE

Do not use an adaptor for compact disc singles—it could cause tracking errors or interfere with the ejection of compact discs.

—Using your audio system:
controls and features

® Type 1-1

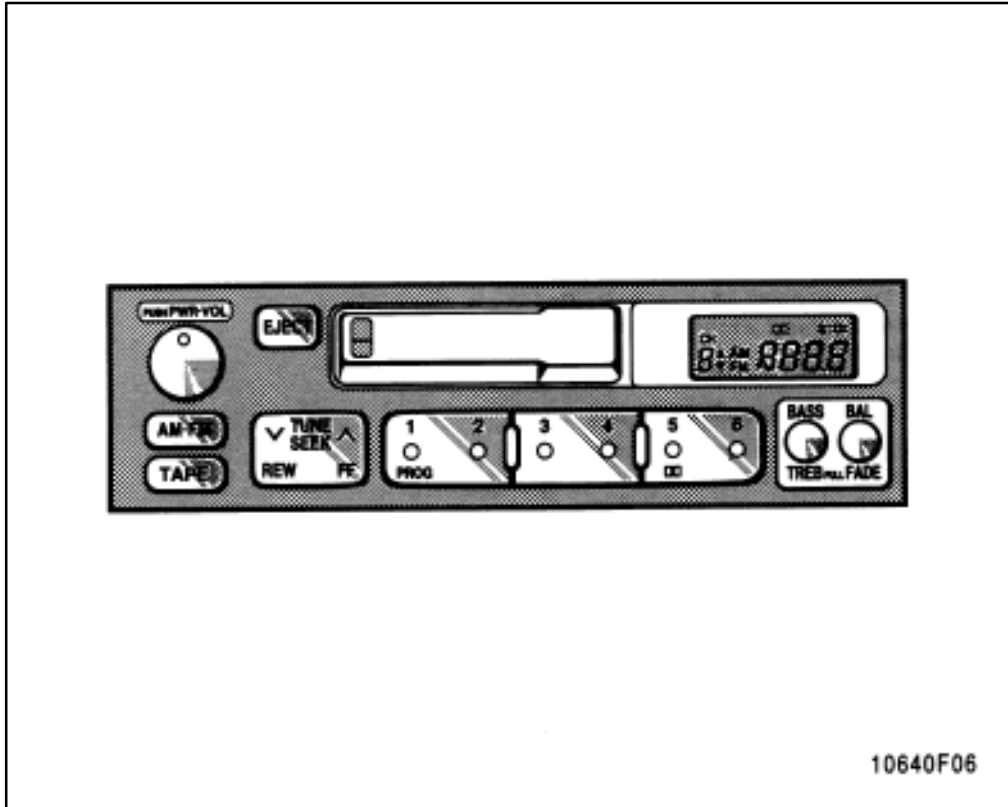

Details of specific buttons, controls, and features are described in the alphabetical listing that follows.

10640F06

® Type 1-2

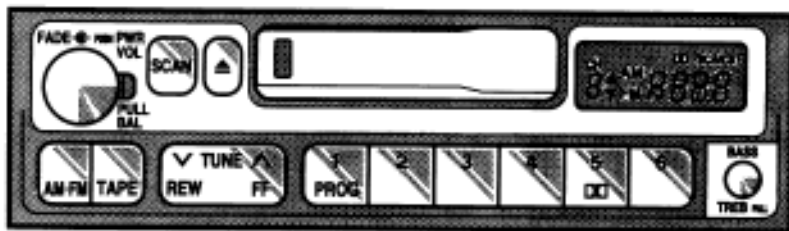

Details of specific buttons, controls, and features are described in the alphabetical listing that follows.

10640F03

® Type 1-3

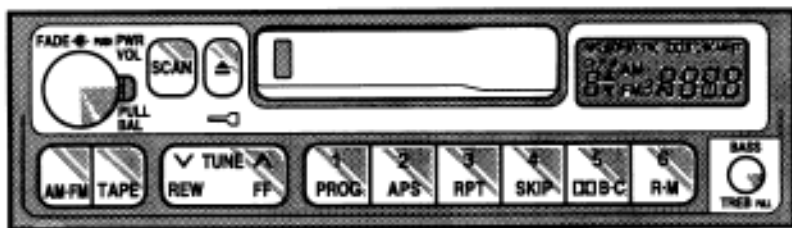

Details of specific buttons, controls, and features are described in the alphabetical listing that follows.

10640F04

1 2 3 4 5 6 (Preset buttons)

These buttons are used to preset and tune in radio stations.

To preset a station to a button: Tune in the desired station (see “TUNE” or “TUNE/SEEK”). Push and hold down the button until you hear a beep—this will set the station to the button. The button number will appear on the display.

To tune in to a preset station: Push the button for the station you want. The button number and station frequency will appear on the display.

Type 1–1 and 1–2—These systems can store one AM and one FM station for each button. The preset station memory will be canceled out if the power source is interrupted (battery disconnected or fuse blown).

Type 1–3—These systems can store one AM and two FM stations for each button. (The display will show “AM”, “FM1”, or “FM2” when you push “AM · FM”.) To cancel out the preset station memory, push “1”, “2”, and “3” at the same time and hold them in until you hear a beep.

/EJECT (Eject button)

Push this button to eject a cassette.

After you turn the ignition to “LOCK”, you will be able to eject a cassette but you will not be able to reinsert it.

AM · FM

Push “AM · FM” to switch between the AM and FM bands.

Type 1–1 and 1–2—“AM” or “FM” will appear on the display.

Type 1–3—“AM”, “FM1” or “FM2” will appear on the display.

If the audio system is off, you can turn on the radio by pushing “AM · FM”. Also, push “AM·FM” to switch from cassette operation to radio operation.

APS (Automatic program selection)

Type 1–3 only

The automatic program selection (APS) feature allows you to program your cassette player to skip forward or backward to locate the song you want to hear. You can skip up to nine tracks at a time.

Push “APS”. “APS” and “1” will appear on the display.

Next, push “APS” until the number on the display reaches the number of tracks you want to skip. If you push “APS” ten times, the APS feature will be turned off.

If you choose the number “1”, the player will rewind to the beginning of the current track.

When counting the number of tracks you want to rewind, remember to count the current track as well. For example, if you want to rewind to a song that is two before the song you are listening to, push “APS” until “3” appears on the display.

Finally, push “REW” or “FF” to choose the direction you want to skip. The player will rewind or fast forward the selected number of tracks and play.

The APS number you select can be higher than the number of tracks remaining on the current cassette side. After the beginning or end of the tape is reached, the player will automatically reverse sides and rewind or fast forward the additional number of tracks.

There must be at least 3 seconds of blank space between tracks in order for the APS feature to work correctly. In addition, the APS feature may not work well with some spoken word, live, or classical recordings.

BAL (Balance)

This knob lets you adjust the balance between the right and left speakers.

BASS

This knob lets you adjust the bass level.

Push “BASS/TREB” so that it pops out of its retracted position. Turn the knob to adjust the bass. Push the knob back into its retracted position.

Dolby® NR*

Type 1–1 and 1–2 only

If you are listening to a tape that was recorded with Dolby® Noise Reduction, push the button marked with the double–D symbol. The double–D symbol will appear on the display. Push the button again to turn off Dolby® NR.

The Dolby NR mode reduces tape noise by about 10 dB. For best sound reproduction, play your tapes with this button on or off according to the mode used for recording the tape.

*: Dolby noise reduction manufactured under license from Dolby Laboratories Licensing Corporation. “DOLBY” and the double D symbol are trademarks of Dolby Laboratories Licensing Corporation.

Dolby® B · C*

Type 1–3 only

If you are listening to a tape that was recorded with Dolby® B or C Noise Reduction, push the button marked with the double–D symbol until the appropriate symbol appears on the display. To turn off Dolby®, push the button until the symbol disappears from the display.

The Dolby B NR mode reduces tape noise by about 10dB. The Dolby C NR mode reduces tape noise by another 10 dB, or about 20 dB total. For best sound reproduction, select the same NR mode that was used to record the tape.

*: Dolby noise reduction manufactured under license from Dolby Laboratories Licensing Corporation. “DOLBY” and the double D symbol are trademarks of Dolby Laboratories Licensing Corporation.

FADE

Move the “FADE” ring around “PWR/VOL” to adjust the front/rear balance.

MTL (Metal) display

Type 1–3 only

If a metal or chrome equivalent cassette tape is put in the cassette player, the player will automatically adapt to it and “MTL” will appear on the display.

PROG (Program)

Type 1–2 and 1–3 only

push “PROG” to select the other side of a cassette tape. The display indicates which side is currently selected (“^” indicates top side, “v” indicates bottom side).

Auto–reverse feature—After the cassette player reaches the end of a tape side, it automatically reverses and begins to play the other side. This is true whether the cassette was playing or fast forwarding.

PWR/VOL (Power/Volume)

Push “PWR/VOL” to turn the audio system on and off. Turn the “PWR/VOL” knob to adjust the volume.

Pull out and then turn “PWR/VOL” to adjust the balance between the right and left speakers. Move “FADE” around “PWR/VOL” to adjust the front/rear balance.

REW/FF (Rewind/Fast forward)

Push the “FF” side of the button to fast forward a cassette tape. “FF” will appear on the display. Push the “REW” side to rewind a tape. “REW” will appear on the display.

To stop the tape while it is fast forwarding, push “FF” or “TAPE”; to stop the tape while it is rewinding, push “REW” or “TAPE”. The tape will immediately begin to play.

If a tape side rewinds completely, the cassette player will stop and then play that same side. If a tape fast forwards completely, the cassette player will play the other side of the tape, using the auto-reverse feature.

R.M (Radio monitor)

Type 1–3 only

The radio monitor feature allows you to listen to the radio while a cassette is being rewound or fast forwarded.

Push “R · M”. “R · M” will appear on the display. Any time you are rewinding or fast forwarding a cassette tape, the radio will play the station that was set most recently. (You can not change the radio station unless you switch out of the cassette player function.)

Push “R · M” again to turn off the R’M feature.

RPT (Repeat)

Type 1–3 only

The repeat feature automatically replays the current cassette.

Push “RPT” while the track is playing. “RPT” will appear on the display. When the track ends, it will automatically be rewound and replayed. This process will be continued until you push the button again to turn off the repeat feature.

There must be at least 3 seconds of blank space between tracks in order for the repeat feature to work correctly.

SCAN

Type 1–2 and 1–3 only

You can either scan all the frequencies on a band or scan only the preset stations for that band.

To scan the preset stations: quickly push and release “SCAN”. If you hear a beep, you held the button too long, and the radio will scan all the frequencies. The radio will tune in the next preset station up the band, stay there for a few seconds, and the move to the next preset station. To select a station, push “SCAN” a second time.

To scan all the frequencies: Push “SCAN” until you hear a beep. The radio will find the next station up the station band, stay there for a few seconds, and then scan again. To select a station, push “SCAN” a second time.

Cassette Player

Type 1–3 only

The cassette player scan feature is similar to the radio scan feature and uses the same button.

Push “SCAN”. “SCAN” will appear on the display. The player will fast forward to the next cassette track, play it for 12 seconds, and then scan again. To select a track, push “SCAN” a second time. If the player reaches the end of one side of a cassette tape, it will continue scanning on the other side.

SKIP

Type 1–3 only

The skip feature allows you to fast forward past long stretches of blank tape. This is especially useful at the end of cassettes.

Push "SKIP". "SKIP" will appear on the display. The cassette player will keep track of how much blank space it plays. Any time it has played about 10 seconds of blank tape, it will automatically fast forward to the next track and begin to play. Push the button a second time to turn off the skip feature.

ST (Stereo reception) display

Your radio automatically changes to stereo reception when a stereo broadcast is received. "ST" appears on the display. If the signal becomes weak, the radio reduces the amount of channel separation to prevent the weak signal from creating noise. If the signal becomes extremely weak, the radio switches from stereo to mono reception.

TAPE

Push "TAPE" to switch from radio operation to cassette operation. If the audio system is off, you can turn on the cassette player by pushing "TAPE". In both cases, a cassette must already be loaded in the player.

TREB (Treble)

This knob lets you adjust the treble level. Push "BASS/TREB" so that it pops out of its retracted position. Pull out the knob. Turn the knob to adjust the treble. Push the knob back into its retracted position.

TUNE/SEEK

Tuning

Your Toyota has an electronic tuning radio (ETR).

Push and release the "∧" (up) or "∨" (down) side of "TUNE/SEEK" to step up or down the station band. If you hear a beep, you held the button too long and the radio will go into the seek mode.

Seeking

In the seek mode, the radio finds and plays the next station up or down the station band.

To seek a station, push and hold the "∧" or "∨" side of "TUNE/SEEK" until you hear a beep. Do this again to find another station.

® Type 2

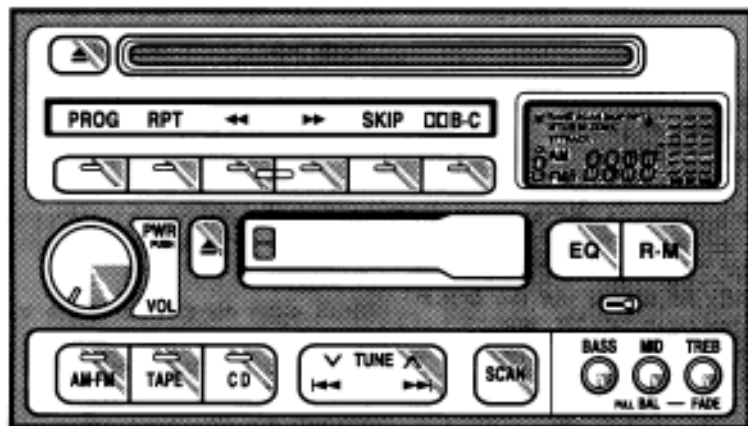

10650F33



10650F23

Button display for radio/cassette tape player/compact disc player

Your audio system shows three different button displays that change in accordance with the audio mode you have selected.

Radio display (display 1)

Cassette player display (display 2)

Compact disc player display (display 3)

Details of specific buttons, controls, and features are described in the alphabetical listing that follows.

1 2 3 4 5 6 (Press buttons)

These buttons are used to preset and tune in radio stations.

To preset a station to a button: Tune in the desired station (see "TUNE" button). Push and hold down the button until you hear a beep—this will set the station to the button. The button number will appear on the display.

To tune in to a preset station: Push the button for the station you want. The button number and station frequency will appear on the display.

These systems can store one AM and two FM stations for each button. (The display will show "AM", "FM1", or "FM2" when you push "AM · FM") To cancel out the preset station memory, push "1", "2", and "3" at the same time and hold them in until you hear a beep.

(Eject Button)

Push the cassette tape eject button to eject a cassette. Push the compact disc eject button to eject a compact disc.

After you turn the ignition to "LOCK", you will be able to eject a cassette or disc but you will not be able to reinsert it.

/ (Track down/up button)

By using this button, you can skip up or down to a different track.

Cassette Player

You can skip up to nine tracks at a time.

Push the up or down side of the button. "1. FF" or "1. REW" will appear on the display.

Next, push either side of the track button until the number on the display reaches the number of tracks you want to skip. If you push the button ten times, the skip feature will be turned off.

When counting the number of tracks you want to rewind, remember to count the current track as well. For example, if you want to rewind to a song that is two before the song you are listening to, push on the down side of the button until "3. REW" appears on the display.

If you have pushed the track button more than you wanted to, push the other side of the button. The track number will be reduced.

The track number you select is not valid if it is higher than the number of tracks remaining on the current cassette side.

After the beginning of the tape is reached, the player will automatically start playing the same side.

After the end of the tape is reached, the player will automatically reverse sides and start playing the other side.

There must be at least 3 seconds of blank space between tracks for the track button to work correctly. In addition, the feature may not work well with some spoken word, live, or classical recordings.

Compact Disc Player

Push either side of the track button until the number of the track you want to listen to appears on the display. If you want to return the beginning of the current track, push the down side of the button one time, quickly.

 (Reverse/Fast forward buttons)

Cassette Player

Push the fast forward button to fast forward a cassette tape. “FF” will appear on the display. Push the reverse button to rewind a tape. “REW” will appear on the display.

To stop the tape while it is fast forwarding, push on the up side of the track down/up button or “TAPE”; to stop the tape while it is rewinding, push on the down side of the track down/up button or “TAPE”.

If a tape side rewinds completely, the cassette player will stop and then play that same side. If a tape fast forwards completely, the cassette player will play the other side of the tape, using the auto-reverse feature.

Compact Disc Player

If you want to fast forward or reverse through a compact disc track, push and hold in the fast forward or reverse button. When you release the button, the compact disc player will resume playing.

AM · FM

Push “AM·FM” to switch between the AM and FM bands. “AM”, “FM1” or “FM2” will appear on the display. These systems allow you to set twelve FM stations, two for each button.

If the audio system is off, you can turn on the radio by pushing “AM · FM”. Also, push “AM · FM” to switch from cassette or compact disc operation to radio operation.

BALL (Balance)

This knob lets you adjust the balance between the right and left speakers.

Push “MID/BAL” so that it pops out of its retracted position. Pull out the knob. Turn the knob to adjust the balance. Push the knob back into its retracted position.

BASS

This knob lets you adjust the bass level. Push “BASS” so that it pops out of its retracted position. Turn the knob to adjust the bass. Push the knob back into its retracted position.

CD (Compact Disc)

Push “CD” to switch from radio or cassette operation to compact disc operation. If the audio system is off, you can turn on the compact disc player by pushing “CD”. In both cases, a disc must already be loaded in the player.

When the audio is set into compact disc operation, the display shows the track number currently being played. Pushing “CD” changes the display to show the length of the current program being played so far. By pushing the button once again, the display returns to that of track number.

Dolby® B · C *

If you are listening to a tape that was recorded with Dolby® B or C Noise Reduction, push the button by the double-D symbol until the appropriate symbol appears on the display. To turn off Dolby® push the button until the symbol disappears from the display.

The Dolby B NR mode reduces tape noise by about 10 dB. The Dolby C NR mode reduces tape noise by another 10 dB, or about 20 dB total. For best sound reproduction, select the same NR mode that was used to record the tape.

*: Dolby noise reduction manufactured under license from Dolby Laboratories Licensing Corporation. “DOLBY” and the double D symbol are trademarks of Dolby Laboratories Licensing Corporation.

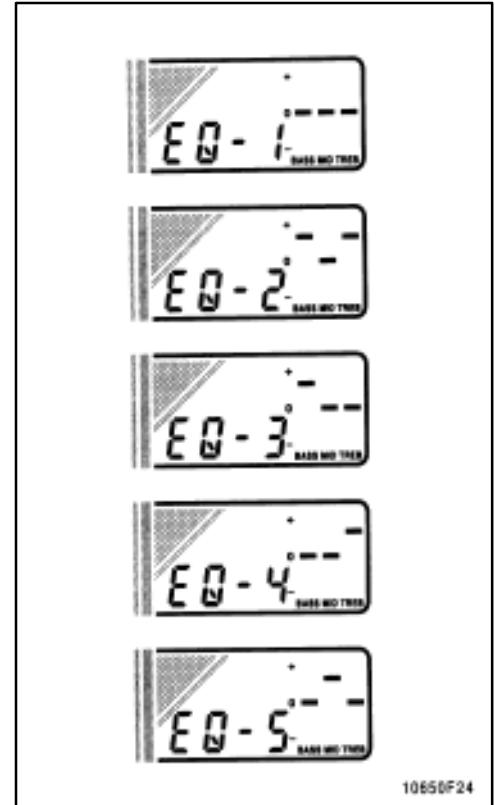

Five EQ settings

EQ (Equalizer)

Your audio system can store five different EQ settings in its memory so that you will not need to readjust it every time you listen to a different program.

Five common settings are stored in the system's memory when it is manufactured (see illustration).

To use a preset EQ setting: Push "EQ". The levers for the first setting and "EQ-1" will appear on the display. Push "EQ" until you reach the setting you want. The audio system will adjust the program you are hearing to the selected setting.

To change a preset EQ setting: Push "EQ" until the setting you want to change appears on the display. Adjust the bass, mid-range, and treble level using the "BASS", "MID/BAL", and "TREB/FADE."

To save an EQ setting: After you have changed a setting, push "EQ" until you hear a beep. This will replace the original factory setting with your new one.

To cancel one of the EQ settings you saved: With the setting on the display, push in and hold "EQ" until you have heard both the first "save" beep and a second beep that means the setting has been canceled. The original factory setting will appear on the display.

To cancel all of the changed EQ settings: Push and hold in "EQ" until you hear a third beep.

FADE

This knob lets you adjust the balance between the front and rear speakers.

Push "TREB/FADE" so that it pops out of its retracted position. Pull out the knob. Turn the knob to adjust the front/rear balance. Push the knob back into its retracted position.

MID (Mid-range)

This knob lets you adjust the mid-range level.

Push "MID/BAL" knob so that it pops out of its retracted position. Turn the knob to adjust the mid-range level. Push the knob back into its retracted position.

MTL (Metal) Display

If a metal or chrome equivalent cassette tape is put in the cassette player, the player will automatically adapt to it and "MTL" will appear on the display.

PROG (Program)

Push "PROG" to select the other side of a cassette tape. The display indicates which side is currently selected ("^" indicates top side, "v" indicates bottom side).

Auto-reverse feature: After the cassette player reaches the end of a tape side, it automatically reverses and begins to play the other side. This is true whether the cassette was playing or fast forwarding.

PWR/VOL (Power/Volume)

Push "PWR/VOL" to turn the audio system on and off. Turn "PWR/VOL" to adjust the volume.

RAND (Random)

The random feature allows you to listen to the tracks on a compact disc in random order.

When you push "RAND", "RAND" will appear on the display and the player will play the tracks in random order. Push the button again to turn off the random feature.

RM (Radio Monitor)

The radio monitor feature allows you to listen to the radio while a cassette is being rewound or fast forwarded.

Push “RM”. “RM” will appear on the display. Any time you are rewinding or fast forwarding a cassette tape, the radio will play the station that was set most recently. (You can not change the radio station unless you switch out of the cassette player function.)

Push “RM” again to turn off the RM feature.

RPT (Repeat)

The repeat feature automatically replays the current cassette or compact disc track.

Push “RPT” while the track is playing. “RPT” will appear on the display. When the track ends, it will automatically be rewound (cassette) and replayed. This process will be continued until you push the button again to turn off the repeat feature.

Cassettes—There must be at least 3 seconds of blank space between tracks in order for the repeat feature to work correctly.

Scan

Radio

You can either scan all the frequencies on a band or scan only the preset stations for that band.

To scan the preset stations: Quickly push and release “SCAN.” If you hear a beep, you held the button too long, and the radio will scan all the frequencies. The radio will tune in the next preset station up the band, stay there for a few seconds, and then move to the next preset station. To select a station, push “SCAN” a second time.

To scan all the frequencies: Push “SCAN” until you hear a beep. The radio will find the next station up the station band, stay there for a few seconds, and then scan again. To select a station, push “SCAN” a second time.

Cassette Player

The cassette player scan feature is similar to the radio scan feature and uses the same button.

Push “SCAN”. “SCAN” will appear on the display. The player will fast forward to the next cassette track, play it for 12 seconds, and then scan again. To select a track, push “SCAN” a second time. If the player reaches the end of one side of a cassette tape, it will continue scanning on the other side.

Compact disc player

The compact disc player scan feature is similar to the radio scan feature.

Push “SCAN”. “SCAN” will appear on the display. The compact disc player will play the next track for 10 seconds, then scan again. To select a track, push “SCAN” a second time. If the player reaches the end of the disc, it will continue scanning at track 1.

SKIP

The skip feature allows you to fast forward past long stretches of blank tape. This is especially useful at the end of cassettes.

Push “SKIP”. “SKIP” will appear on the display. The cassette player will keep track of how much blank space it plays. Any time it has played about 10 seconds of blank tape, it will automatically fast forward to the next track and begin to play.

Push the button a second time to turn off the skip feature.

ST (Stereo reception) display

Your radio automatically changes to stereo reception when a stereo broadcast is received. “ST” appears on the display. If the signal becomes weak, the radio reduces the amount of channel separation to prevent the weak signal from creating noise. If the signal becomes extremely weak, the radio switches from stereo to mono reception.

TAPE

Push “TAPE” to switch from radio or compact disc operation to cassette operation. If the audio system is off, you can turn on the cassette player by pushing “TAPE”. In both cases, a cassette must already be loaded in the player.

TREB (Treble)

This knob lets you adjust the treble level. Push “TREB/BASS” so that it pops out of its retracted position. Turn the knob to adjust the treble. Push the knob back into its retracted position.

TUNE

Tuning

Your Toyota has an electronic tuning radio (ETR).

Push and release the “^” (up) or “v” (down) side of “TUNE” to step up or down the station band. (If you hear a beep, you held the button too long and the radio will go into the seek mode.)

Seeking

In the seek mode, the radio finds and plays the next station up or down the station band.

To seek a station, push and hold the “^” or “v” side of “TUNE” until you hear a beep. Do this again to find another station.

—Anti-theft system (type 1–3 and 2 only)

The anti-theft system prevents the audio system from working after it has been disconnected. To activate the system, you must set a three-digit security code. After the system is set, “SEC” will appear in the display each time the ignition is turned form “LOCK” or “ACC” or “ON”. Also, the anti-theft light flashes every few seconds while the ignition key is in the “LOCK” position.

You will need to know your security code to reactivate your radio after electrical service is performed on your vehicle.

Choose a security code that is easy to remember and keep a copy of it (not in your Toyota).

NOTICE

If you pushed any wrong buttons on the anti-theft system, the following messages will appear on the display.

“Err”—You have pushed wrong buttons.

“1-9”—Indicates the number of errors you have made. You may make up to nine errors, but no more!
“HELP”—The number of error you can make was exceeded. The audio sytem is completely inoperable. Contact you Toyota dealer.

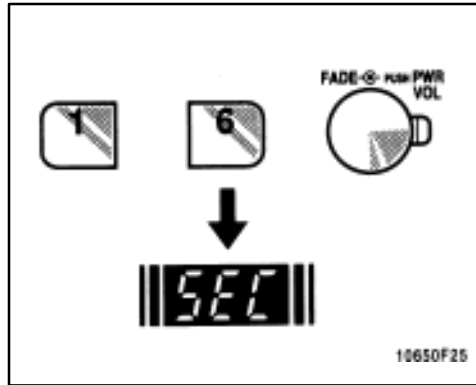

Setting a security code for the first time.

1. Turn off the audio system. Turn the ignition key to “ACC”. Simultaneously push and hold in “1”, “6”, and “PWR/VOL” until “SEC” appears on the display.

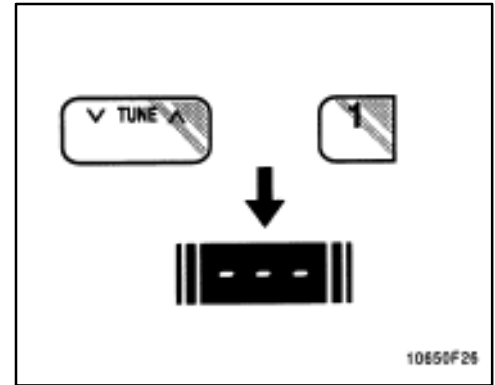

2. While you are holding in the “^” side of “TUNE”, push “1”. The display will read “—”. On some modes, “▼” and “▲” will also turn on.

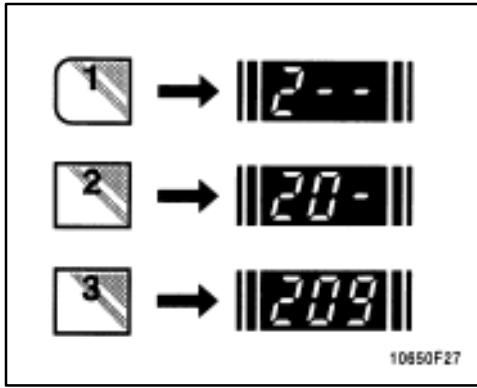

3. Input the three digit code.
 You have 10 seconds to enter each digit.
 For example, “209”:
 To set the first digit: Push “1” until the digit you want appears on the display.
 To set the second digit: Push “2” until the digit you want appears on the display.
 To set the third digit: Push “3” until the digit you want appears on the display.

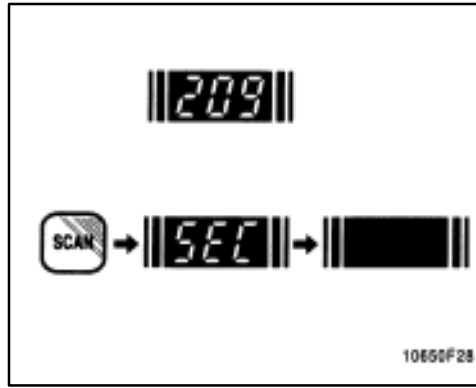

4. The three–digit code should be on the display.
 Push and hold in “SCAN” until the display goes dark. (At first, “SEC” will appear on the display.)

If you pushed any wrong buttons, “Err” and the number of errors you have made will appear on the display before “SEC” does. Go back to step 2 and try again. If the display returns to “—” while you are entering the code, go back to step 3.

To make sure the security code has been accepted, turn the ignition to “LOCK” and then back to “ACC.” “SEC” should appear on the display.

Choose a security code that is easy to remember and keep a copy of it (not in your Toyota).

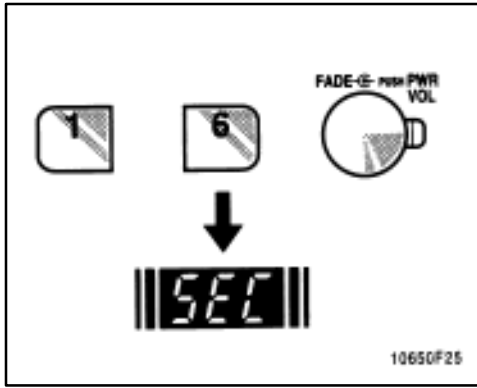

Changing the security code

1. Turn off the audio system.

Turn the ignition key to “ACC”.

Simultaneously push and hold in “1”, “6”, and “PWR/VOL” until “SEC” appears on the display.

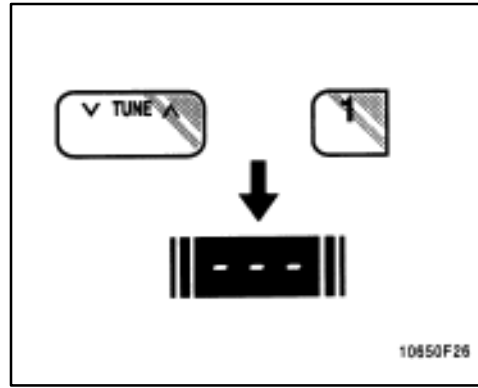

2. While you are holding in the “^” side of “TUNE” push “1”.

The display will read “—”.

On some models, “▼” and “▲” will also turn on.

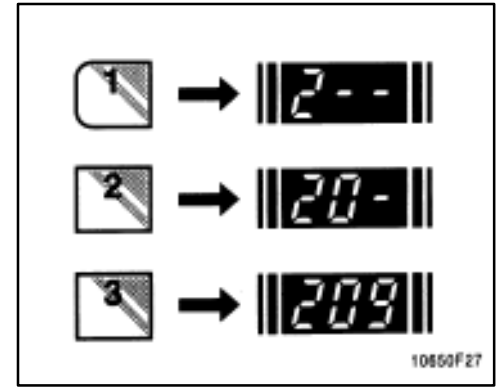

3. Input the existing three-digit code.

You have 10 seconds to enter each digit.

For example, “209”:

To set the first digit: Push “1” until the digit you want appears on the display.

To set the second digit: Push “2” until the digit you want appears on the display.

To set the third digit: Push “3” until the digit you want appears on the display.

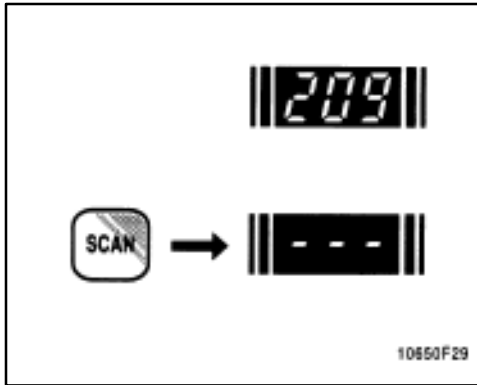

4. The three-digit code should be on the display.
Push "SCAN".
5. Repeat steps 2 and 3, this time entering your new code. You can use digits "0" through "9".

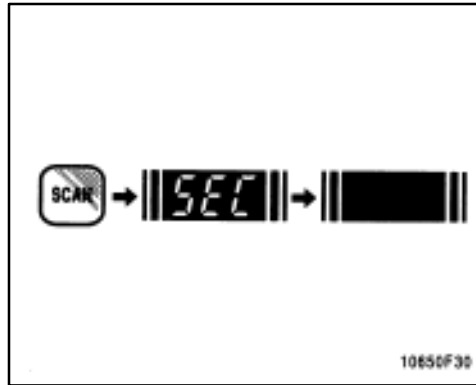

6. The new three-digit code should be on the display.
Push and hold in "SCAN" until the display goes dark. (At first, "SEC" will appear on the display.)

If you pushed any wrong buttons, "Err" and the number of errors you have made will appear on the display before "SEC" does. Go back to step 2 and try again. If the display returns to "—" while you are entering the code, go back to step 3.

To make sure the security code has been accepted, turn the ignition to "LOCK" and then back to "ACC". "SEC" should appear on the display.

NOTICE

A tenth error will activate the anti-theft system and "HELP" will appear on the display. The audio system will be completely inoperable. At this time, the anti-theft light also comes on. If this occurs, contact your Toyota dealer.

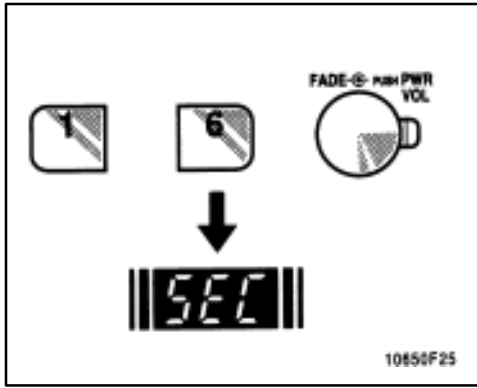

Cleaning the security code.

1. Turn off the audio system.

Turn the ignition key to “ACC”.

Simultaneously push and hold in “1”, “6”, and “PWR/VOL” until “SEC” appears on the display.

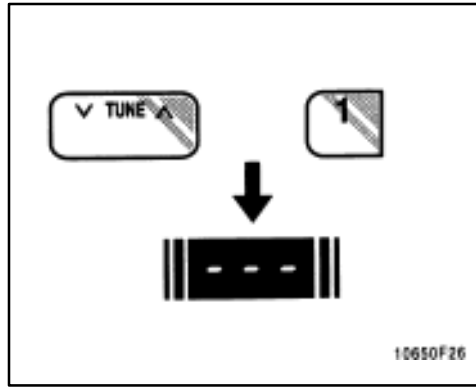

2. While you are holding in the “^” side of “TUNE”, push “1”.

The display will read “—”.

On some models, “▼” and “▲” will also turn on.

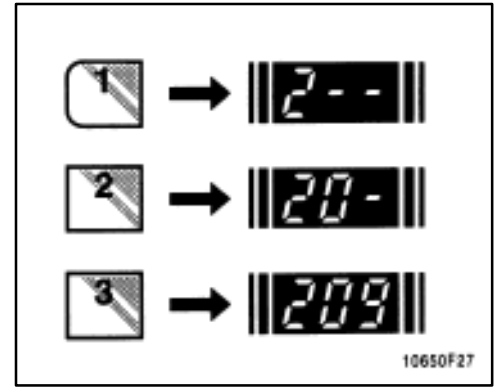

3. Input the existing three-digit code.

You have 10 seconds to enter each digit. For example, “209”:

To set the first digit: Push “1” until the digit you want appears on the display.

To set the second digit: Push “2” until the digit you want appears on the display.

To set the third digit: Push “3” until the digit you want appears on the display.

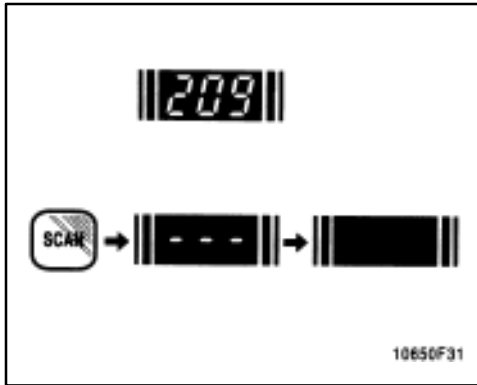

4. The three-digit code should be on the display.
Push “SCAN”.
The display will read “—”.
5. Wait for 10 seconds until the security system is deactivated and the display goes dark.

If you pushed any wrong buttons, “Err” and the number of errors you have made will appear on the display before “SEC” does. Go back to step 2 and try again. If the display returns to “—” while you are entering the code, go back to step 3.

NOTICE

A tenth error will activate the anti-theft system and “HELP” will appear on the display. The audio system will be completely inoperable. At this time, the anti-theft light also comes on. If this occurs, contact your Toyota dealer.

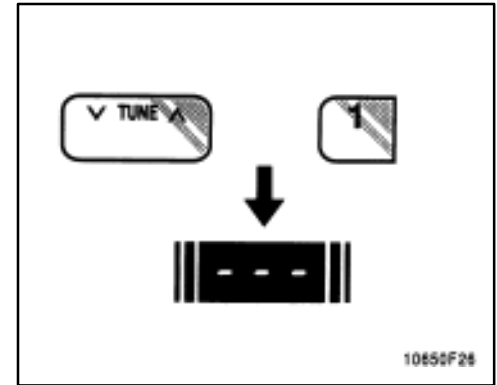

Reactivating a disabled audio system

1. Turn the ignition switch to “ACC”.
2. While you are holding in the “^” side of “TUNE”, push “1”.

The display will read “—”.

On some models, “▼” and “▲” will also turn on.

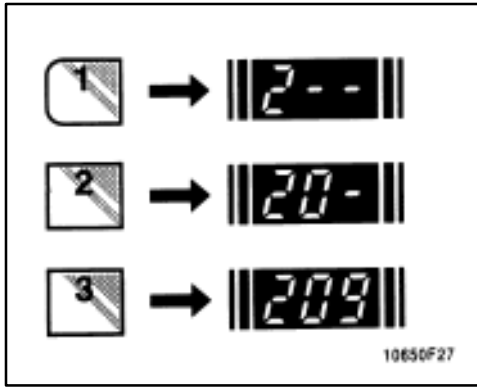

3. Input the existing three-digit code. You have 10 seconds to enter each digit. For example, “209”:
 To set the first digit: Push “1” until the digit you want appears on the display.
 To set the second digit: Push “2” until the digit you want appears on the display.
 To set the third digit: Push “3” until the digit you want appears on the display.

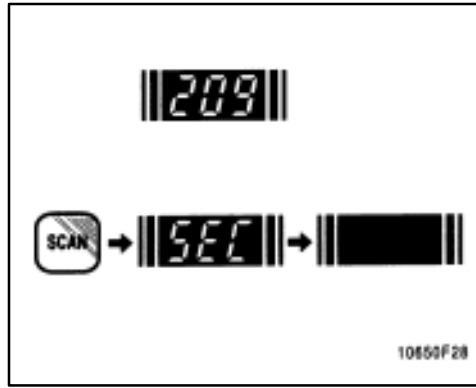

4. The three-digit code should be on the display.
 Push and hold in “SCAN” until the display goes dark. (At first, “SEC” will appear on the display.)

If you pushed any wrong buttons, “Err” and the number of errors you have made will appear on the display before “SEC” does. Go back to step 2 and try again. If the display returns to “—” while you are entering the code, go back to step 3.

To make sure the security code has been accepted, turn the ignition to “LOCK” and then back to “ACC”. “SEC” should appear on the display.

NOTICE

A tenth error will activate the anti-theft system and “HELP” will appear on the display. The audio system will be completely inoperable. At this time, the anti-theft light also comes on. If this occurs, contact your Toyota dealer.

—Car audio system operating hints

NOTICE

To ensure the correct audio system operation:

Be careful not to spill beverages over the audio system.

Do not put anything other than a cassette tape or CD magazine into the cassette tape slot or CD changer.

ILLUMINATION CONTROL LOGIC

On some audio-units, when the instrument panel lights are on, the letters on operable buttons of the mode in current use light up together with the mode selection and eject buttons.

RADIO RECEPTION

Usually, a problem with radio reception does not mean there is a problem with your radio—it is just the normal result of conditions outside the vehicle.

For example, nearby buildings and terrain can interfere with FM reception. Power lines or telephone wires can interfere with AM signals. And of course, radio signals have a limited range, and the farther you are from a station, the weaker its signal will be. In addition, reception conditions change constantly as your vehicle moves. Here are some common reception problems that probably do not indicate a problem with your radio:

FM

Fading and drifting stations—Generally, the effective range of FM is about 40 km (25 miles). Once outside this range, you may notice fading and drifting, which increase with the distance from the radio transmitter. They are often accompanied by distortion.

Multi-path—FM signals are reflective, making it possible for two signals to reach your antenna at the same time. If this happens, the signals will cancel each other out, causing a momentary flutter or loss of reception.

Static and fluttering—These occur when signals are blocked by buildings, trees, or other large objects. Increasing the bass level may reduce static and fluttering.

Station swapping—If the FM signal you are listening to is interrupted or weakened, and there is another strong station nearby on the FM band, your radio may tune in the second station until the original signal can be picked up again.

AM

Fading—AM broadcasts are reflected by the upper atmosphere—especially at night. These reflected signals can interfere with those received directly from the radio station, causing the radio station to sound alternately strong and weak.

Station interference—when a reflected signal and a signal received directly from a radio station are very nearly the same frequency, they can interfere with each other, making it difficult to hear the broadcast.

Static—AM is easily affected by external sources of electrical noise, such as high tension power lines, lightning, or electrical motors. This results in static.

CARING FOR YOUR CASSETTE PLAYER AND TAPES

For high performance from your cassette player and tapes:

Clean the tape head and other parts regularly.

A dirty tape head or tape path can decrease sound quality and tangle your cassette tapes. The easiest way to clean them is by using a cleaning tape. (A wet type is recommended.)

Use high-quality cassettes.

Low-quality cassette tapes can cause many problems, including poor sound, inconsistent playing speed, and constant auto-reversing. They can also get stuck or tangled in the cassette player.

Do not use a cassette if it has been damaged or tangled or if its label is peeling off.

Do not leave a cassette in the player if you are not listening to it, especially if it is hot outside.

Store cassettes in their cases and out of direct sunlight.

Avoid using cassettes with a total playing time longer than 100 minutes (50 minutes per side). The tape used in these cassettes is thin and could get stuck or tangled in the cassette player.



CARING FOR YOUR COMPACT DISC PLAYER AND DISCS

Use only compact discs labeled as shown.

Extremely high temperatures can keep your compact disc player from working. On hot days, use the air conditioning to cool the vehicle interior before you listen to a disc.

Bumpy roads or other vibrations may make your compact disc player skip.

If moisture gets into your compact disc player, you may not hear any sound even though your compact disc player appears to be working. Remove the disc from the player and wait until it dries.

Handle compact discs carefully, especially when you are inserting them. Hold them on the edge and do not bend them. Avoid getting fingerprints on them, particularly on the shiny side. Dirt, scrapes, warping, pin holes, or other disc damage could cause the player to skip or to repeat a section of a track. (To see a pin hole, hold the disc up to the light.)

Remove discs from the compact disc player when you are not listening to them. Store them in their plastic cases away from moisture, heat, and direct sunlight.

To clean a compact disc: Wipe it with a soft, lint-free cloth that has been dampened with water. Wipe in a straight line from the center to the edge of the disc (not in circles). Dry it with another soft, lint-free cloth. Do not use a conventional record cleaner or anti-static device.

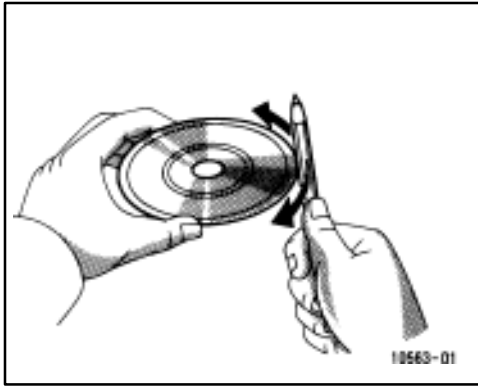

A new disc may have rough edges on its inner and outer perimeter. Remove the rough edges by pressing the side of a ball-point pen or pencil against the inner and outer perimeter of the disc as shown.

If you continue to play a disc with rough edges, flakes will fall on to the signal side of the disc and cause sound skipping or other problems.



Compact disc players use invisible laser beam which could cause hazardous radiation exposure if directed outside the unit. Be sure to operate the player correctly as instructed.

Air conditioning system— —Controls

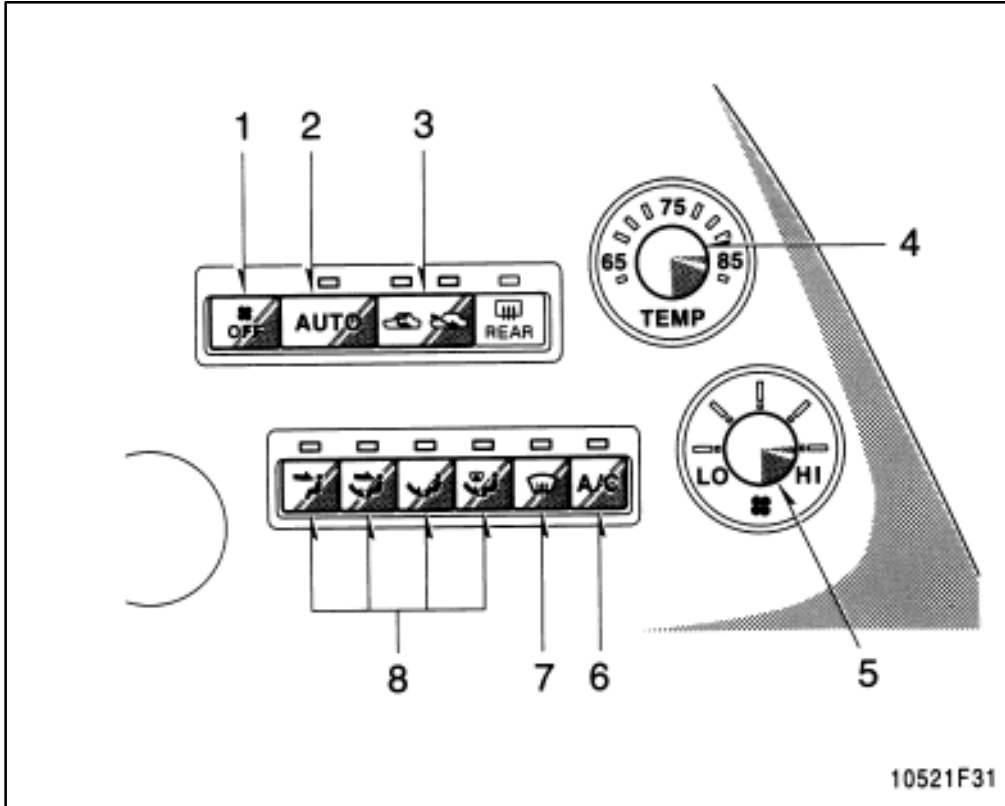

“AUTO” button

For automatic operation of the air conditioning, press the “AUTO” button. An indicator light will illuminate to show that the automatic operation mode has been selected.

In the automatic operation mode, the air conditioning selects the most suitable air intake, fan speed and air flow according to the temperature.

You may use manual controls if you want to select your own settings.

To turn off the automatic operation, press the “OFF” button.

Fan speed selector

Turn the knob to adjust the fan speed—to the right to increase, to the left to decrease.

In automatic operation, you do not have to adjust the fan speed unless you desire another fan speed mode.

Temperature selector

Turn the knob to adjust the temperature—to the right to warm, to the left to cool.

“OFF” button

Push the button to turn off the air conditioning system.

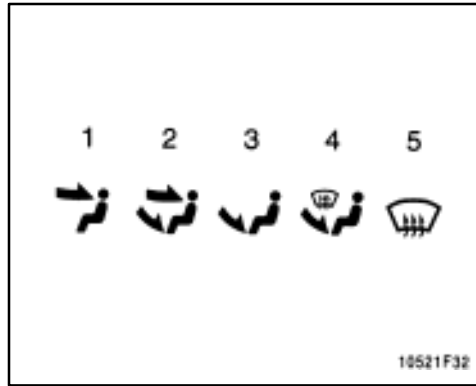

Air flow selector

Press the buttons to select the vents used for air flow.

In automatic operation, you do not have to select the air flow unless you desire another air flow mode.

1. **Panel**—Air flows mainly from the instrument panel vents.
2. **Bi-level**—Air flows from both the floor vents and the instrument panel vents.
3. **Floor**—Air flows mainly from the floor vents.
4. **Floor/Windshield**—Air flows mainly from the floor vents and windshield vents.

5. **Windshield**—Air flows mainly from the windshield vents.

Pressing the button once again returns the air flow mode to the last one used.

Pressing the windshield air flow button turns on the defroster-linked air conditioning. At this time, the “A/C” button indicator comes on regardless of whether or not the “A/C” button is pressed in. This is to clean up front view more quickly.

For details about air flow selector settings, see the illustration after “A/C” button.

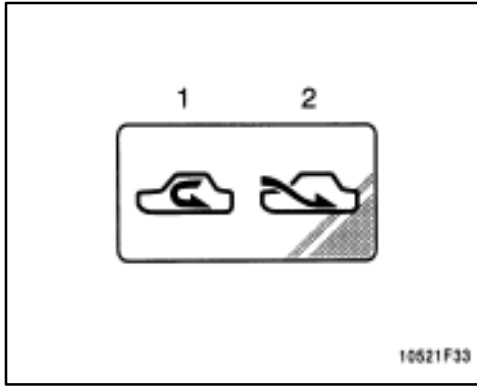

Air Intake selector

Press the button to select the air source.

- 1. Recirculate**—Recirculates the air inside the vehicle.
- 2. Fresh**—Draws outside air into the system.

In automatic operation, you do not have to select the air intake unless you desire another air intake mode.

“A/C” button

To turn on the air conditioning, press the “A/C” button. The “A/C” button indicator will come on. To turn the air conditioning off, press the button again.

If the “A/C” button indicator flashes, there is a problem in the air conditioning system and the air conditioning automatically shuts off. If this happens, take your vehicle to a Toyota dealer for service.

—Air flow selector settings

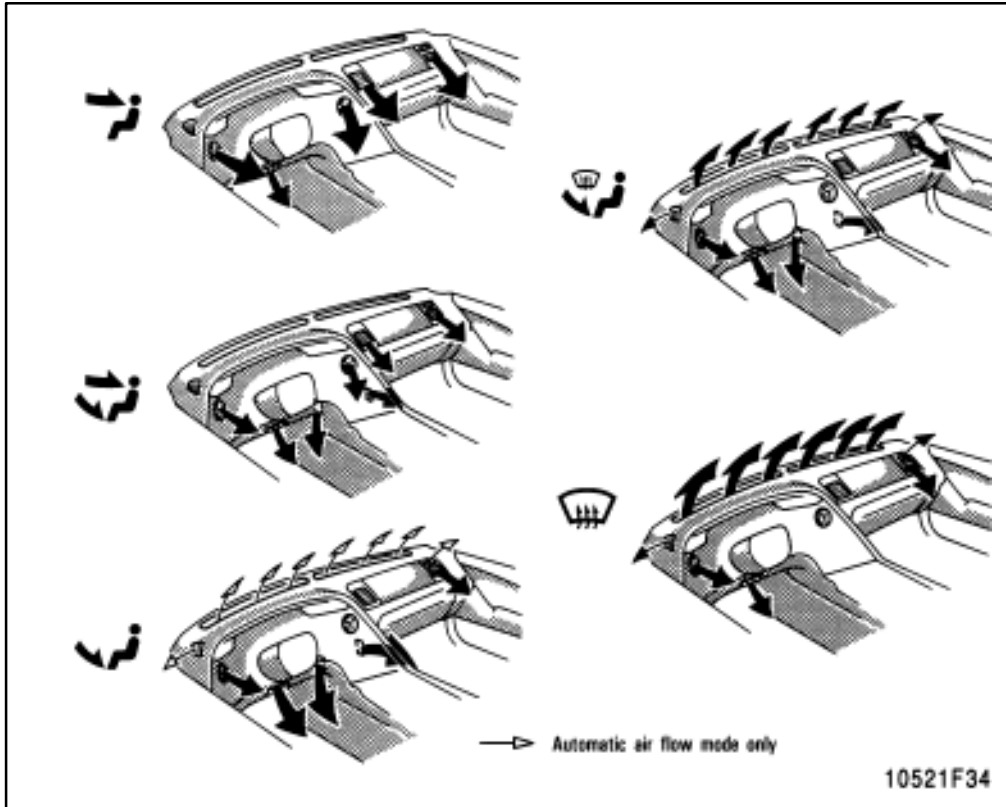

—Operating tips

- Ⓡ To cool off your Toyota after it has been parked in the hot sun, drive with the windows open for a few minutes. This vents the hot air, allowing the air conditioning to cool the interior more quickly.
- Ⓡ Make sure the air intake grilles in front of the windshield are not blocked (by leaves or snow, for example).
- Ⓡ On humid days, do not blow cold air on the windshield. The windshield could fog up because of the difference in air temperature on the inside and outside of the windshield.
- Ⓡ Keep the area under the front seats clear to allow air to circulate throughout the vehicle.
- Ⓡ On cold days, move the fan speed to "HI" for a minute to help clear the intake ducts of snow or moisture. This can reduce the amount of fogging on the windows.

Heating

For best results, set controls to:

For automatic operation—

Press in the “AUTO” button.
Temperature— To the desired
temperature
Air conditioning—OFF

For manual operation—

Fan speed—To the desired fan speed
Temperature— To the desired
temperature
Air intake—FRESH (outside air)
Air flow—FLOOR
Air conditioning—OFF

- ® For quick heating, select recirculated air for a few minutes. To keep the windows from fogging, select fresh after the vehicle interior has been warmed.
- ® Press the “A/C” button on for dehumidified heating.
- ® Choose floor/windshield air flow to heat the vehicle interior while defrosting the windshield.

Air conditioning

For best results, set controls to:

For automatic operation—

Press in the “AUTO” button.
Temperature— To the desired
temperature
Air conditioning—ON

For manual operation—

Fan speed—To the desired fan speed
Temperature— To the desired
temperature
Air intake—FRESH (outside air)
Air flow—PANEL
Air conditioning—ON

- ® For quick cooling, move the air intake selector to recirculate for a few minutes.

Ventilation

For best results, set controls to:

For automatic operation—

Press in the “AUTO” button.
Temperature— Towards low
temperature
Air conditioning—OFF

For manual operation—

Fan speed—To the desired fan speed
Temperature— Towards low
temperature
Air intake—FRESH (outside air)
Air flow—PANEL
Air conditioning—OFF

Defogging and defrosting

—The inside of the windshield

For best results, set controls to:

Temperature— Towards high temperature to heat; low temperature to cool

Air intake—**FRESH** (outside air)

Air flow—**WINDSHIELD**

Pressing the windshield air flow button turns on the defroster-linked air conditioning. At this time, the “A/C” button indicator comes on regardless of whether or not the “A/C” button is pressed in. This is to clean up front view more quickly.

® On humid days, do not blow cold air on the windshield—the difference between the outside and inside temperatures could make the fogging worse.

—The outside of the windshield

For best results, set controls to:

Temperature— Towards high temperature

Air intake—**FRESH** (outside air)

Air flow—**WINDSHIELD**

Pressing the windshield air flow button turns on the defroster-linked air conditioning. At this time, the “A/C” button indicator comes on regardless of whether or not the “A/C” button is pressed in. This is to clean up front view more quickly.

® To heat the vehicle interior while defrosting the windshield, choose floor/windshield air flow.

—Instrument panel vents

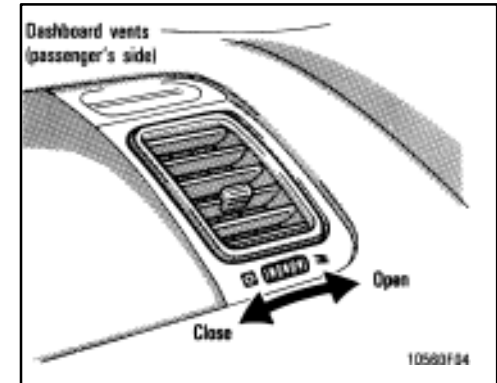
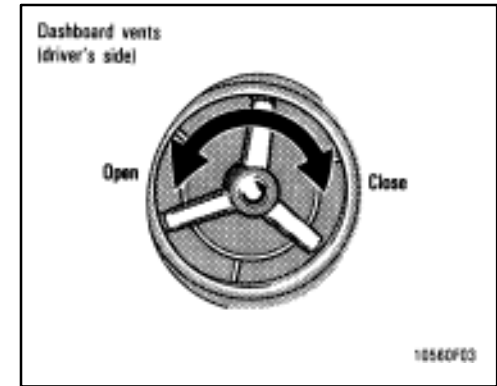

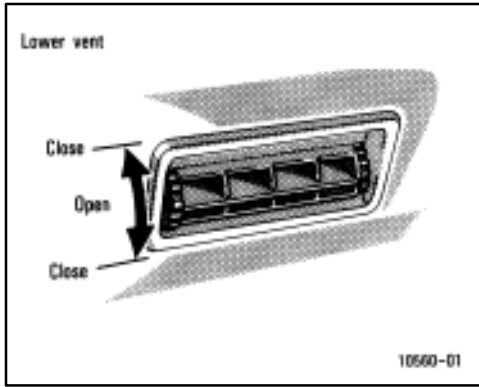

If air flow control is not satisfactory, check the instrument panel vents. The instrument panel vents may be opened or closed as shown.

Part 1

OPERATION OF INSTRUMENTS AND CONTROLS—

Chapter 1–8

Other equipment

- Ⓡ Clock
- Ⓡ Cigarette lighter and ashtray
- Ⓡ Glovebox
- Ⓡ Miscellany box
- Ⓡ Luggage cover
- Ⓡ Traction control system
- Ⓡ Floor mat

Clock



Once the electrical power source has been disconnected from the clock, the time is automatically set to 1:00 (one o'clock).

The digital clock indicates the time with the ignition key at the “ACC” or “ON” position. To reset the hour, depress the “H” button. To reset the minutes, depress the “M” button. To adjust the time to full hour, depress the “:00” button.

For example, if the “:00” button is depressed when the time is between 1:01—1:29, the time will change to 1:00. If the time is between 1:30—1:59, the time will change to 2:00.

When the instrument panel lights are turned on, the brightness of the time indication will be reduced.

Cigarette lighter and ashtray

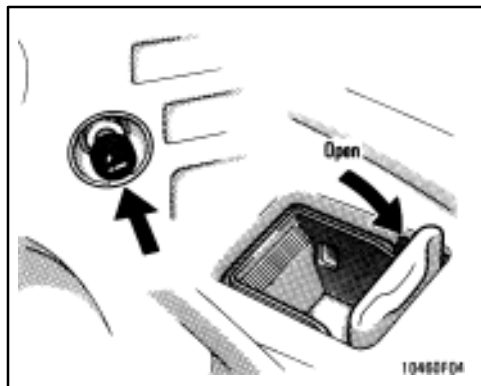

To operate the cigarette lighter, press it in. When it becomes heated, it automatically pops out ready for use.

If the engine is not running, the key must be in the "ACC" position.

Do not hold the cigarette lighter pressed in.

When finished with your cigarette, thoroughly extinguish it in the ashtray to prevent other cigarette butts from catching fire. After using the ashtray, close the ashtray cover completely.

To remove the ashtray, open the ashtray cover and pull it out.

Use a Toyota genuine cigarette lighter or equivalent for replacement.



To reduce the chance of injury in case of an accident or sudden stop while driving, always close the ashtray cover completely after using.

Glovebox

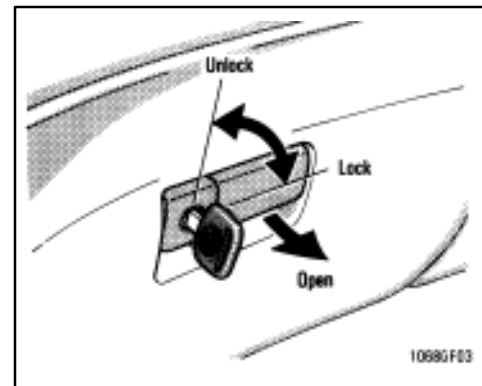

To open the glovebox door, pull the lever. To lock the glovebox door, insert the master key and turn it clockwise.

With the instrument panel lights on, the glovebox light will come on when the door is open.



To reduce the chance of injury in case of an accident or sudden stop, always keep the glovebox door closed while driving.

Miscellany box

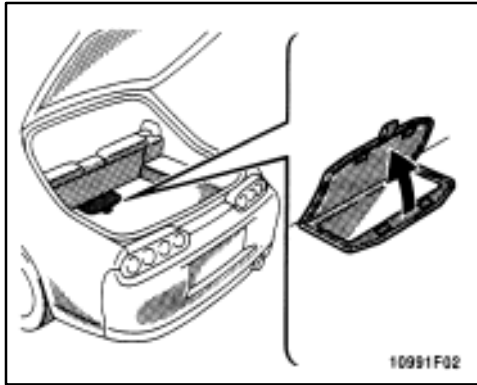

To open the box, pull up the strap.

Luggage cover

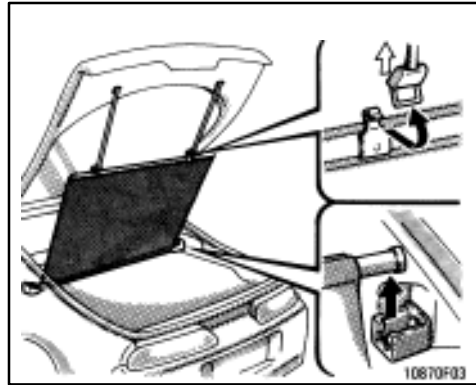

When you open the back door, the luggage cover tilt ups for easy access to the luggage area.

Traction control system

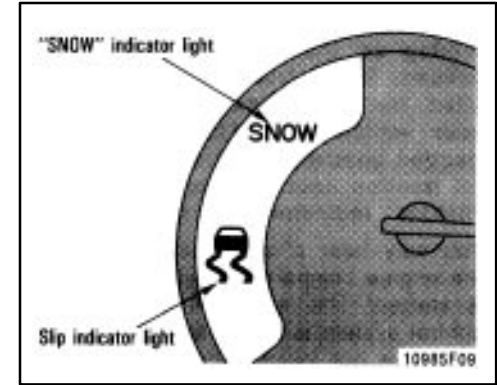

AUTOMATIC MODE

The traction control system automatically controls the spinning of the rear wheels which may occur when accelerating on slippery road surfaces, thus assisting driver control and driving power to the rear wheels. When you turn the ignition switch on, the traction control system always turns on automatically, and the slip indicator light and "SNOW" indicator light will come on. The indicator lights will go off after about 3 seconds.

Leave the system on during ordinary driving so that it can operate when needed. When traction control is applied, the slip indicator light blinks. If your vehicle still skids even though traction control is applied, more powerful traction control is applied and the “SNOW” indicator light comes on.

You may hear a slight clicking noise in the engine compartment when the engine is started. This means that the traction control system is in the self-check mode, and does not indicate malfunction. When the traction control system is operating, you may feel vibration of your vehicle, caused by operation of the brakes. This indicates the system is functioning properly.

When getting the vehicle out of mud or new snow, etc. the traction control system will operate to prevent the wheels from spinning. Even though the accelerator pedal is fully depressed, the engine speed will be restrained to a certain level.

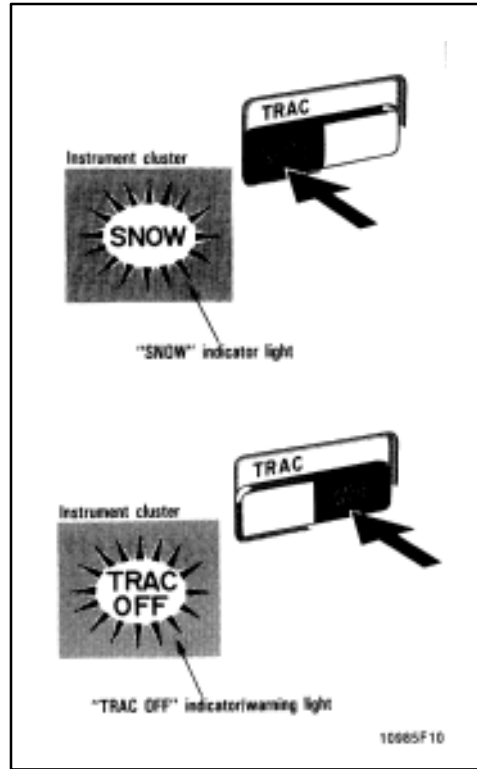

MANUAL SNOW OPERATION

You can select the snow mode by pushing the “SNOW” switch. The “SNOW” indicator light will come on.

To select the automatic mode, push the “OFF” switch. The “SNOW” indicator light will go off. If your vehicle still skids, the system automatically operates.

MANUAL TRACTION CONTROL OFF OPERATION

You can turn off the traction control system by pushing the “OFF” switch. The “TRAC OFF” indicator/warning light will come on. Pushing the “OFF” switch a second time turns on the traction control system and the “TRAC OFF” indicator/warning light will go off.

If the “SNOW” indicator light is on, pushing the “OFF” switch once selects the automatic mode and pushing it a second time turns off the traction control system.



CAUTION

Under certain slippery road conditions, full stability of the vehicle and power to the rear wheels cannot be maintained, even though the traction control system is in operation. In situations where the road surface is covered with ice or snow, your vehicle should be fitted with snow tires or tire chains and driven at a more cautious pace.

Floor mat

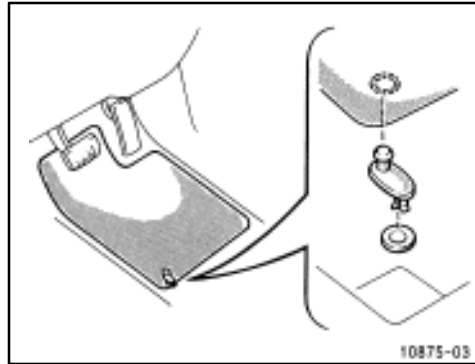

Use a floor mat of the correct size.

If the floor mat has a hole, then it is designed for use with a locking clip. Fix the floor mat and locking clip into the hole in the floor carpet.

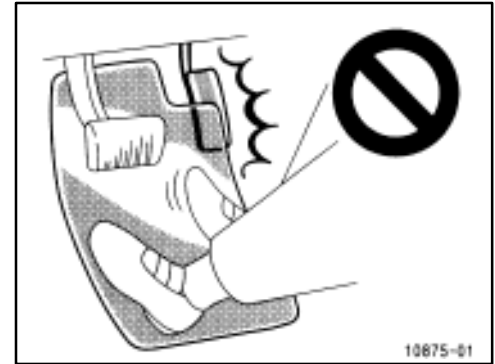

CAUTION

Make sure the floor mat is properly placed on the floor carpet. If the floor mat slips and interferes with the movement of the pedals during driving, it may cause an accident.

Part 2

INFORMATION BEFORE DRIVING YOUR TOYOTA

- Ⓜ Break-in period
- Ⓜ Fuel
- Ⓜ Operation in foreign countries
- Ⓜ Three-way catalytic converters
- Ⓜ Engine exhaust cautions
- Ⓜ Facts about engine oil consumption
- Ⓜ Brake system
- Ⓜ Brake pad wear limit indicators
- Ⓜ Luggage stowage precautions
- Ⓜ Limited-slip differential
- Ⓜ Your Toyota's identification
- Ⓜ Theft prevention labels
- Ⓜ Suspension and chassis
- Ⓜ Types of tires

Break-in period

Drive gently and avoid high speeds.

Your vehicle does not need an elaborate break-in. But following a few simple tips for the first 1600 km (1000 miles) can add to the future economy and long life of your vehicle:

- Ⓜ Do not drive over 88 km/h (55 mph).
- Ⓜ Do not run the engine over 4000 rpm. Maintain engine speed between 2000 and 4000 rpm.
- Ⓜ Avoid full-throttle starts.
- Ⓜ Try to avoid hard stops during the first 300 km (200 miles).
- Ⓜ Do not drive slowly with the manual transmission in a high gear.
- Ⓜ Do not drive for a long time at any single speed, either fast or slow.

Fuel

FUEL TYPE

Your new vehicle must use only unleaded gasoline.

To help prevent gas station mixups, your Toyota has a new smaller fuel tank opening. The special nozzle on pumps with unleaded fuel will fit it, but the larger standard nozzle on pumps with leaded gas will not.

NOTICE

Do not use leaded gasoline. Use of leaded gasoline will cause the three-way catalytic converter to lose its effectiveness and the emission control system to function improperly. Also, this can increase maintenance costs.

OCTANE NUMBER

Select premium unleaded gasoline with a Research Octane Number of 96 (Octane Rating 91) or higher for optimum engine performance. However, if such premium type cannot be obtained, you may temporarily use unleaded gasoline with an octane number as low as 91 (Octane Rating 87).

Use of unleaded fuel with an octane number or rating lower than stated above will cause persistent heavy knocking. If severe, this will lead to engine damage.

If your engine knocks...

If you detect heavy knocking even when using the recommended fuel, or if you hear steady knocking while holding a steady speed on level roads, consult your Toyota dealer.

However, now and then, you may notice light knocking for a short time while accelerating or driving up hills. This is no cause for concern.

GASOLINES CONTAINING DETERGENT ADDITIVES

Toyota recommends use of gasolines that contain detergent additives to avoid build-up of engine deposits.

For further details, ask your Toyota dealer or a local gasoline retailer..

GASOLINES CONTAINING MTBE

Gasolines that contain MTBE (Methyl Tertiary-Butyl Ether) are available in the market. If you use a gasoline mixed with MTBE, make certain that it does not contain more than 15% of MTBE.

If the use of gasolines containing MTBE causes poor driveability and/or poor fuel economy, you should discontinue the use of fuels containing MTBE.

GASOLINES CONTAINING ALCOHOL

If the use of gasohol in your Toyota, be sure that it is unleaded, has an octane rating no lower than 87 and does not contain more than 10% ethanol.

Gasohol is a mixture of gasoline and ethanol.

Toyota does not recommend the use of gasolines containing methanol. If you use gasoline containing methanol, use only gasoline meeting the requirements above and also containing less than 5% methanol with cosolvents and corrosion inhibitors for methanol.

NOTICE

◀ ***Do not use gasohol other than stated above. It will cause fuel system damage or vehicle performance problems.***

◀ ***If driveability problems are encountered (poor hot starting, vaporizing, engine knock, etc.), discontinue the use.***

◀ ***Take care not to spill gasohol during refueling. Gasohol may cause paint damage.***

FUEL TANK CAPACITY

70 L (18.5 gal., 15.4 Imp. gal)

Operation in foreign countries

If you plan to drive your Toyota in another country...

First, comply with the vehicle registration laws.

Second, confirm the availability of the correct fuel (unleaded and minimum octane number).

Three-way catalytic converters

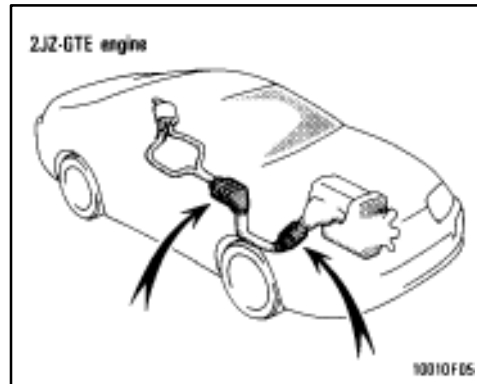
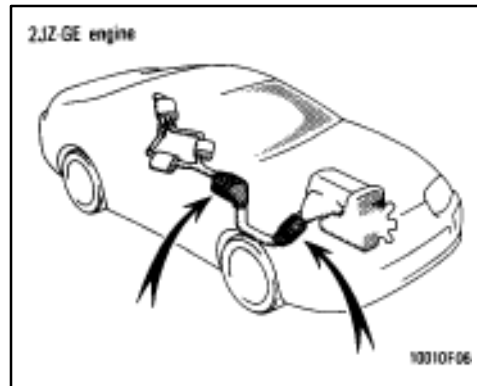

The three-way catalytic converter is an emission control device installed in the exhaust system.

Its purpose is to reduce pollutants in the exhaust gas.



- Ⓢ Keep people and combustible materials away from the exhaust pipe while the engine is running. The exhaust gas is very hot.
- Ⓢ Do not drive, idle or park your vehicle over anything that might burn easily such as grass, leaves, paper or rags.

NOTICE

A large amount of unburned gases flowing into the three-way catalytic converter may cause it to overheat and create a fire hazard. To prevent this and other damage, observe the following precautions:

◀ *Use only unleaded gasoline.*

Engine Exhaust Cautions

- ◀ *Do not drive with an extremely low fuel level; running out of fuel could cause the engine to misfire, creating an excessive load on the three-way catalytic converter.*
- ◀ *Do not allow the engine to run at idle speed for more than 20 minutes.*
- ◀ *Avoid racing the engine.*
- ◀ *Do not push-start or pull-start your vehicle.*
- ◀ *Do not turn off the ignition while the vehicle is moving.*
- ◀ *Keep your engine in good running order. Malfunctions in the engine electrical system, electronic ignition system/distributor ignition system or fuel system could cause an extremely high three-way catalytic converter temperature.*
- ◀ *If the engine becomes difficult to start or stalls frequently, take your vehicle in for a check-up as soon as possible. Remember, your Toyota dealer knows your vehicle and its three-way catalytic converter system best.*

◀ *To ensure that the three-way catalytic converter and the entire emission control system operate properly, your vehicle must receive the periodic inspections required by the Toyota Maintenance Schedule. For scheduled maintenance information, refer to the separate "Owner's Manual Supplement/Maintenance Schedule".*



CAUTION

- ⑥ **Avoid inhaling the engine exhaust.** It contains carbon monoxide, which is a colorless and odorless gas. It can cause unconsciousness or even death.
- ⑥ **Make sure the exhaust system has no holes or loose connections.** The system should be checked from time to time. If you hit something, or notice a change in the sound of the exhaust, have the system checked immediately.
- ⑥ **Do not run the engine in a garage or enclosed area except for the time needed to drive the vehicle in or out.** The exhaust gases cannot escape, making this a particularly dangerous situation.
- ⑥ **Do not remain for a long time in a parked vehicle with the engine running.** If it is unavoidable, however, do so only in an unconfined area and adjust the heating or cooling system to force outside air into the vehicle.

Facts about engine oil consumption

FUNCTIONS OF ENGINE OIL

Engine oil has the primary functions of lubricating and cooling the inside of the engine, and plays a major role in maintaining the engine in proper working order.

ENGINE OIL CONSUMPTION

It is normal that an engine should consume some engine oil during normal engine operation. The causes of oil consumption in a normal engine are as follows.

® Oil is used to lubricate pistons, piston rings and cylinders. A thin film of oil is left on the cylinder wall when a piston moves downwards in the cylinder. High negative pressure generated when the vehicle is decelerating sucks some of this oil into the combustion chamber. This oil as well as some part of the oil film left on the cylinder wall is burned by the high temperature combustion gases during the combustion process.

® Oil is also used to lubricate the stems of the intake valves. Some of this oil is sucked into the combustion chamber together with the intake air and is burned along with the fuel. High temperature exhaust gases also burn the oil used to lubricate the exhaust valve stems.

The amount of engine oil consumed depends on the viscosity of the oil, the quality of the oil and the conditions the vehicle is driven under.

More oil is consumed by high-speed driving and frequent acceleration and deceleration.

A new engine consumes more oil, since its pistons, piston rings and cylinder walls have not become conditioned.

When judging the amount of oil consumption, note that the oil may become diluted and make it difficult to judge the true level accurately.

As an example, if a vehicle is used for repeated short trips, and consumes a normal amount of oil, the dipstick may not show any drop in the oil level at all, even after 1000 km (600 miles) or more. This is because the oil is gradually becoming diluted with the fuel or moisture, making it appear that the oil level has not changed.

® **Keep the back door closed while driving. An open or unsealed trunklid may cause exhaust gases to be drawn into the vehicle. If you must drive with the trunklid open to accommodate a large object, close the windows, open all the instrument panel vents and have the heating or cooling system deliver fresh air into the vehicle by turning the fan to high speed with the air intake control lever set at the OUTSIDE AIR position.**

® **To allow proper operation of your vehicle's ventilation system, keep the inlet grilles in front of the windshield clear of snow, leaves, or other obstructions.**

® **If you smell exhaust fumes in the vehicle, drive with the windows open and the back door closed. Have the cause immediately located and corrected.**

The diluting ingredients evaporate out when the vehicle is then driven at high speeds, as on an expressway, making it appear that oil is excessively consumed after driving at high speeds.

IMPORTANCE OF ENGINE OIL LEVEL CHECK

One of the most important points in proper vehicle maintenance is to keep the engine oil at the optimum level so that oil function will not be impaired. Therefore, it is essential that the oil level be checked regularly. Toyota recommends that the oil level be checked every time you refuel the vehicle.

NOTICE

Failure to check the oil level regularly could lead to serious engine trouble due to insufficient oil.

For detailed information on the oil level check, see “Checking the engine oil level” in Chapter 7–2.

Brake system

TANDEM MASTER CYLINDER BRAKE SYSTEM

The tandem master cylinder brake system is a hydraulic system with two separate sub-systems. If either sub-system should fail, the other will still work. However, the pedal will be harder to press, and your stopping distance will be longer. Also, the brake system warning light may come on.



Do not drive your vehicle with only a single brake system. Have your brakes fixed immediately.

BRAKE BOOSTER

The brake booster uses engine vacuum to power-assist the brakes. If the engine should quit while you are driving, you can bring the vehicle to a stop with normal pedal pressure. There is enough reserve vacuum for one or two stops – but no more!



- Ⓢ **Do not pump the brake pedal if the engine stalls. Each push on the pedal uses up your vacuum reserve.**
- Ⓢ **Even if the power assist is completely lost, the brakes will still work. But you will have to push the pedal hard—much harder than normal. And your braking distance will be longer.**

ANTI-LOCK BRAKE SYSTEM

The anti-lock brake system is designed to automatically prevent lock-up of the wheels during sudden braking or braking on slippery road surfaces. This assists in providing directional stability and steering performance of the vehicle under these circumstances.

The anti-lock brake system becomes operative after the vehicle has accelerated to a speed in excess of approximately 10 km/h (6 mph). It stops operating when the vehicle decelerates to a speed below approximately 5 km/h (3 mph).

You may hear a sound in the engine compartment for a few seconds when the engine is started or just after the vehicle is started. This means that the anti-lock brake system is in the self check mode, and does not indicate a malfunction.

Effective way to press the “ABS” brake pedal:

When the anti-lock brake system function is in action, you may feel the brake pedal pulsating and hear a noise. In this situation, to let the anti-lock brake system work for you, just hold the brake pedal down more firmly. Do not pump the brake. This will result in reduced braking performance.

The brake pedal pulsation caused by the anti-lock brake system may indicate hazardous road surface conditions. Although the anti-lock brake system assists in providing vehicle control, it is still important to drive with all due care, because the anti-lock brake system cannot overcome the laws of physics that act on your vehicle:

® Braking capability is dependent on tire friction with the road surface.

- ® Even though the anti-lock brake system is operating, a driver cannot maintain full control on certain slippery road surfaces, when cornering at high speeds, or in violent maneuvers.
- ® Avoid high speeds on wet roads. The anti-lock brake system cannot eliminate the risk of hydroplaning and loss of tire friction.

Always maintain a safe distance from the vehicle in front of you. Compared with vehicles not fitted with an anti-lock brake system, your vehicle may require a longer stopping distance in the following cases:

- ® Driving on rough, gravel or snow-covered roads.
- ® Driving with tire chains installed.
- ® Driving on roads where the road surface is pitted or has other differences in surface height.

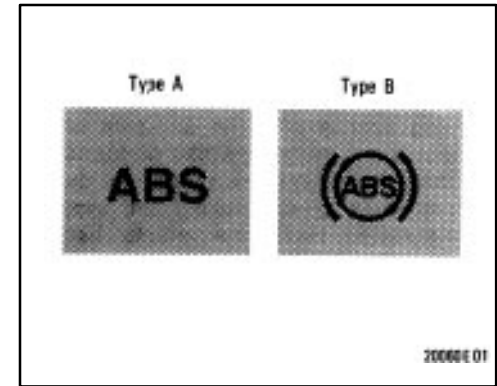

“ABS” warning light

This light comes on when the ignition key is turned to the “ON” position. After about 3 seconds, the light will go off.

If either of the following conditions occurs, this indicates a malfunction somewhere in the parts monitored by the warning light system. Contact your Toyota dealer as soon as possible to service the vehicle.

- ® The light does not come on as described above, or remains on.
- ® The light comes on while driving.

Even if the anti-lock brake system should fail, the brake system will still operate conventionally. However, when the 'ABS' warning light is on (and the brake system warning light is off), the anti-lock brake system is not assisting brake performance so that the wheels can lock-up during sudden braking or braking on slippery road surfaces. Have your vehicle checked by your Toyota dealer as soon as possible

DRUM-IN-DISC TYPE PARKING BRAKE SYSTEM

Your vehicle has a drum-in-disc type parking brake system. This type brake system needs bedding-down of the brake shoes periodically or whenever the parking brake shoes and/or drums are replaced.

Have your Toyota dealer perform the bedding-down.

Brake pad wear limit indicators

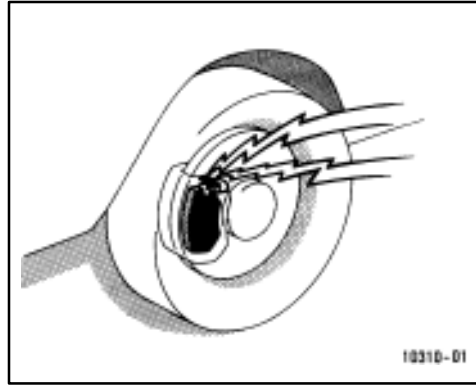

The brake pad wear limit indicators on your disc brakes give a warning noise when the brake pads are worn to where replacement is required.

If you hear a squealing or scraping noise while driving, have the brake pads checked and replaced by your Toyota dealer as soon as possible. Expensive rotor damage can result if the pads are not replaced when necessary.

Luggage storage precautions

When stowing luggage or cargo in or on the vehicle, observe the following:

- Ⓡ Put luggage or cargo in the luggage compartment when at all possible. Be sure all items are secured in place.
- Ⓡ Be careful to keep the vehicle balanced. Locating the weight as far forward as possible helps maintain balance.
- Ⓡ For better fuel economy, do not carry unneeded weight.



- Ⓡ **To prevent luggage or packages from sliding forward during braking, do not stack anything in the luggage compartment higher than the seatbacks. Keep luggage or packages low, as close to the floor as possible.**
- Ⓡ **Never allow anyone to ride in the luggage compartment. It is not designed for passengers. They should ride in their seats with their seat belts properly fastened. Otherwise, they are much more likely suffer serious bodily injury, in the event of sudden braking or a collision.**

- Ⓢ Do not place anything on the flattened seat, or it may slide forward during braking.
- Ⓢ Do not drive with objects left on top of the instrument panel. They may interfere with the driver's field of view. Or they may move during sharp vehicle acceleration or turning, and impair the driver's control of the vehicle. In an accident they may injure the vehicle occupants.

NOTICE

- ◀ Do not load the vehicle beyond the vehicle capacity weight specified in Part 8.
- ◀ If using a roof luggage carrier on sport roofs, avoid prolonged driving on rough roads with heavy items on the roof luggage carrier.

Limited-slip differential

Some Toyotas are equipped with a limited-slip differential. If one rear wheel begins to spin, the limited-slip differential is designed to aid traction by automatically transmitting driving force to the other rear wheel. If you are not sure whether your vehicle is equipped with one, you can ask your Toyota dealer.



Do not start or run the engine while your vehicle is supported by a jack. The vehicle could be driven off the jack and could pose a danger or result in serious injury.

NOTICE

Use only a spare tire of the same size, construction and load capacity as the original tires on your Toyota because damage to the limited-slip differential could possibly occur with another type.

Your Toyota's identification

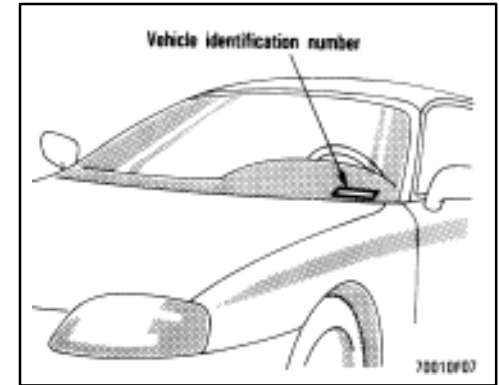

The vehicle identification number (VIN) is the legal identifier for your vehicle. This number is on the left top of the instrument panel, and can be seen through the windshield from outside.

The vehicle identification number (VIN) is also on the Certification Label.

This is the primary identification number for your Toyota. It is used in registering the ownership of your vehicle.

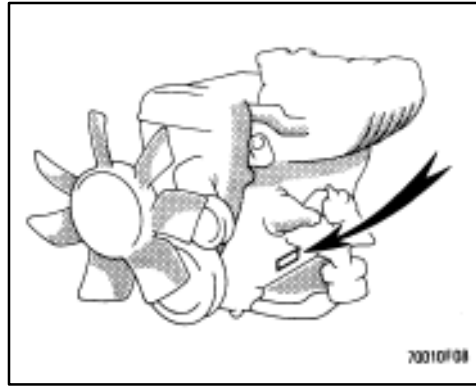
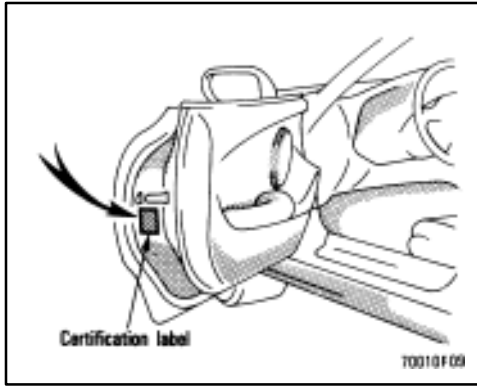

The engine number is stamped on the engine block as shown

Theft prevention labels (except for Canada)

Your new vehicle carries theft prevention labels which are approximately 56 mm (2.20 in.) by 16 mm (0.63 in.).

The purpose of these labels is to reduce the incidence of vehicle thefts by facilitating the tracing and recovery of parts from stolen vehicles. The label is designed so that once it is applied to a surface, any attempt to remove it will result in destroying the integrity of the label. Transferring these labels intact from one part to another, will be impossible.

NOTICE

You should not attempt to remove the theft prevention labels as it may violate certain state or federal laws.

Suspension and chassis



Do not modify the suspension/chassis with lift kits, spacers, springs, etc. It can cause dangerous handling characteristics resulting in loss of control.

Types of tires

Determine what kind of tires your vehicle is originally equipped with

1. Summer tires.

Summer tires are high-speed capability tires best suited to highway driving under dry conditions.

Since summer tires do not have the same traction performance as snow tires, summer tires are inadequate for driving on snow-covered or icy roads. For driving on snow-covered or icy roads, we recommend using snow tires. If installing snow tires, be sure to replace all four tires.

2. All season tires

All season tires are designed to provide better traction in snow and to be adequate for driving in most winter conditions, as well as for use all year round.

All season tires, however, do not have adequate traction performance compared with snow tires in heavy or loose snow. Also, all season tires fall short in acceleration and handling performance compared with summer tires in highway driving.



Ⓢ Do not mix summer and all season tires on your vehicle as this can cause dangerous handling characteristics, resulting in loss of control.

Ⓢ Do not use tires other than the manufacturer's designated tires, and do not mix tires or wheels of the sizes different from the original.

Part 3

STARTING AND DRIVING

- ® [Before starting the engine](#)
- ® [How to start the engine](#)
- ® [Precautions for turning off engine with turbocharger](#)
- ® [Tips for driving in various conditions](#)
- ® [Winter driving tips](#)
- ® [Trailer towing](#)
- ® [How to save fuel and make your vehicle last longer, too](#)

Before starting the engine

1. Check the area around the vehicle before entering it.
2. Adjust seat position, seatback angle and steering wheel angle.
3. Adjust inside and outside rear view mirrors.
4. Lock all doors.
5. Fasten seat belts.

How to start the engine— (a) Before cranking

1. Apply the parking brake firmly.
2. Turn off unnecessary lights and accessories.
3. **Manual transmission:** Press the clutch pedal to the floor and shift the transmission into neutral. Hold the clutch pedal to the floor until the engine is started. A starter safety device will prevent the starter from operating if the clutch pedal is not fully depressed.
Automatic transmission: Put the selector lever in “P”. If you need to restart the engine while the vehicle is moving, put the selector lever in “N”. A starter safety device will prevent the starter from operating if the selector lever is in any drive position.
4. **Automatic transmission only:** Depress the brake pedal and hold it to the floor until driving off.

(b) Starting the engine

Before starting the engine, be sure to follow the instructions in “(a) Before cranking”.

Normal starting procedure

The multiport fuel injection system/sequential multiport fuel injection system in your engine automatically controls the proper air–fuel mixture for starting. You can start a cold or hot engine as follows:

1. With your foot off the accelerator pedal, crank the engine by turning the key to “START”. Release it when the engine starts.
2. After the engine runs for about 10 seconds, you are ready to drive.

If the weather is below freezing, let the engine warm up for a few minutes before driving.

If the engine stalls...

Simply restart it, using the correct procedure given in normal starting.

If the engine will not start—

See “If your vehicle will not start” in Part 4.

NOTICE

◀ **Do not crank for more than 30 seconds at a time. This may overheat the starter and wiring systems.**

◀ **Do not race a cold engine.**

◀ **If the engine becomes difficult to start or stalls frequently, have the engine checked immediately.**

Precautions for turning off an engine with turbocharger (2JZ–GTE engine)

After high–speed or extended driving, etc., required a heavy engine load, the engine should be allowed to idle, as shown in the chart, before turning it off.

Driving condition and required idling time

Normal city driving

Idling time—Not necessary

High–speed driving

About 80 km/h (50 mph)

Idling time—About 20 seconds

About 100 km/h (63 mph)

Idling time—About 1 minute

Steep mountain slopes or continued driving

above 100 km/h (63 mph)

Idling time—About 2 minutes

NOTICE

Never turn the engine off immediately after a heavy load. This may cause severe engine damage.

Tips for driving in various conditions

- Ⓡ Always slow down in gusty crosswinds. This will allow you much better control
- Ⓡ Drive slowly onto curbs and, if possible, at a right angle. Avoid driving onto high, sharp-edged objects and other road hazards. Failure to do so can lead to severe tire damage resulting in tire bursts.
- Ⓡ When parking on a hill, turn the front wheels until they touch the curb so that the vehicle will not roll. Apply the parking brake, and place the transmission in “P” (automatic) or in first or reverse (manual). If necessary, block the wheels.
- Ⓡ Washing your vehicle or driving through deep water may get the brakes wet. To see whether they are wet, check that there is no traffic near you, and then press the pedal lightly. If you do not feel a normal braking force, the brakes are probably wet. To dry them, drive the vehicle cautiously while lightly pressing the brake pedal with the parking brake pulled. If they still do not work safely, pull to the side of the road and call a Toyota dealer for assistance.



- Ⓡ **Before driving off, make sure that the parking brake is fully released and the parking brake reminder light is off.**
- Ⓡ **Do not leave your vehicle unattended while the engine is running.**
- Ⓡ **Do not rest your foot on the brake pedal while driving. It can cause dangerous overheating, needless wear, and poor fuel economy.**
- Ⓡ **To drive down a long or steep hill, reduce your speed and downshift. Remember, if you ride the brakes excessively, they may overheat and not work properly.**
- Ⓡ **Be careful when accelerating, upshifting, downshifting or braking on a slippery surface. Sudden acceleration or engine braking, could cause the vehicle to spin or skid.**

- Ⓡ **Do not drive in excess of the speed limit. Even if the legal speed limit permits it, do not drive over 140 km/h (85 mph) unless your vehicle has high-speed capability tires. Driving over 140 km/h (85 mph) may result in tire failure, loss of control and possible injury. Be sure to consult a tire dealer to determine whether the tires on your vehicle are high-speed capability tires or not before driving at such speeds.**
- Ⓡ **Do not continue normal driving when the brakes are wet. If they are wet, your vehicle will require a longer stopping distance, and it may pull to one side when the brakes are applied. Also, the parking brake will not hold the vehicle securely.**

Winter driving tips

Make sure you have ethylene–glycol antifreeze in the radiator.

NOTICE

Do not use alcohol type antifreeze.

Check the condition of the battery and cables.

Cold temperatures reduce the capacity of any battery, so it must be in top shape to provide enough power for winter starting. Chapter 7–3 tells you how to visually inspect the battery. Your Toyota dealer and most service stations will be pleased to check the level of charge.

Make sure the engine oil viscosity is suitable for the cold weather.

See Chapter 7–2 for recommended viscosity. Leaving a heavy summer oil in your vehicle during winter months may cause harder starting. If you are not sure about which oil to use, call your Toyota dealer—he will be pleased to help.

Keep the door locks from freezing.

Squirt lock de–icer or glycerine into the locks to keep them from freezing. To open a frozen lock, try heating the key before inserting it.

Use a washer fluid containing an anti-freeze solution.

This product is available at your Toyota dealer and most auto parts stores. Follow the manufacturer’s directions for how much to mix with water.

NOTICE

Do not use engine antifreeze or any other substitute as washer fluid because it may damage your vehicle’s paint.

Do not use your parking brake when there is a possibility it could freeze.

When parking, put the transmission into “P” (automatic) or into first or reverse (manual) and block the rear wheels. Do not use the parking brake, or snow or water accumulated in and around the parking brake mechanism may freeze, making it hard to release.

Keep ice and snow from accumulating under the fenders.

Ice and snow built up under your fenders can make steering difficult. During bad winter driving, stop and check under the fenders occasionally.

Depending on where you are driving, we recommend you carry some emergency equipment.

Some of the things you might put in the vehicle are tire chains, window scraper, bag of sand or salt, flares, small shovel, jumper cables, etc.

Trailer towing

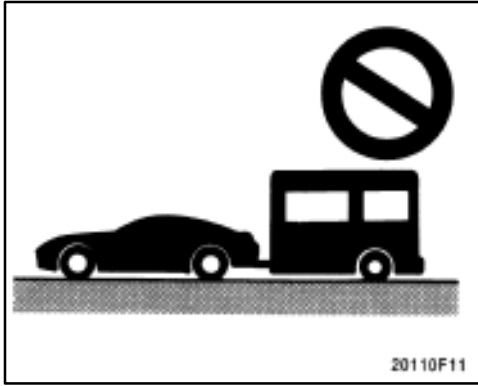

Toyota does not recommend towing a trailer with your Supra. It is not designed for trailer towing.

How to save fuel and make your vehicle last longer, too

Getting more kilometers/mileage from a liter/gallon of fuel is easy—just take it easy. It will help make your vehicle last longer, too. Here are some specific tips on how to save money on both fuel and repairs:

- ® **Keep your tires inflated at the correct pressure.** Underinflation causes tire wear and wastes fuel. See Chapter 7–2 for instructions.
- ® **Do not carry unneeded weight in your vehicle.** Excess weight puts a heavier load on the engine, causing greater fuel consumption.
- ® **Avoid lengthy warm-up idling.** Once the engine is running smoothly, begin driving—but gently. Remember, however, that on cold winter days this may take a little longer.
- ® **Accelerate slowly and smoothly.** Avoid jackrabbit starts. Get into high gear as quickly as possible.
- ® **Avoid long engine idling.** If you have a long wait and you are not in traffic, it is better to turn off the engine and start again later.
- ® **Avoid engine lug or overrevving.** Use a gear position suitable for the road on which you are travelling.

- ® **Avoid continuous speeding up and slowing down.** Stop-and-go driving wastes fuel.
- ® **Avoid unnecessary stopping and braking.** Maintain a steady pace. Try to time the traffic signals so you only need to stop as little as possible or take advantage of through streets to avoid traffic lights. Keep a proper distance from other vehicles to avoid sudden braking. This will also reduce wear on your brakes.
- ® **Avoid heavy traffic or traffic jams whenever possible.**
- ® **Do not rest your foot on the clutch or brake pedal.** This causes needless wear, overheating and poor fuel economy.
- ® **Maintain a moderate speed on highways.** The faster you drive, the greater the fuel consumption. By reducing your speed, you will cut down on fuel consumption.
- ® **Keep the front wheels in proper alignment.** Avoid hitting the curb and slow down on rough roads. Improper alignment not only causes faster tire wear but also puts an extra load on the engine, which, in turn, wastes fuel.

- ® **Keep the bottom of your vehicle free from mud, etc.** This not only lessens weight but also helps prevent corrosion.
- ® **Keep your vehicle tuned-up and in top shape.** A dirty air cleaner, improper valve clearance, dirty plugs, dirty oil and grease, brakes not adjusted, etc. all lower engine performance and contribute to poor fuel economy. For longer life of all parts and lower operating costs, keep all maintenance work on schedule, and if you often drive under severe conditions, see that your vehicle receives more frequent maintenance (For scheduled maintenance information, please refer to the separate "Owner's Manual Supplement/Maintenance Schedule").



Never turn off the engine to coast down hills. Your power steering and brake booster will not function without the engine running. Also, the emission control system operates properly only when the engine is running.

Part 4

IN CASE OF AN EMERGENCY

- Ⓜ If your vehicle will not start
- Ⓜ If your engine stalls while driving
- Ⓜ If your vehicle overheats
- Ⓜ If you have a flat tire
- Ⓜ If your vehicle needs to be towed
- Ⓜ If you cannot shift automatic transmission selector lever
- Ⓜ If you lose your keys

If your vehicle will not start— (a) Simple checks

Before making these checks, make sure you have followed the correct starting procedure given in “How to start the engine” in Part 3 and that you have sufficient fuel.

If the engine is not turning over or is turning over too slowly—

1. Check that the battery terminals are tight and clean.
2. If the battery terminals are O.K., switch on the interior light.
3. If the light is out, dim or goes out when the starter is cranked, the battery is discharged. You may try jump starting. See “(c) Jump starting” for further instructions.

If the light is O.K., but the engine still will not start, it needs adjustment or repair. Call a Toyota dealer or qualified repair shop.

NOTICE

Do not pull— or push—start the vehicle. It may damage the vehicle or cause a collision when the engine starts. Also the three-way catalytic converter may overheat and become a fire hazard.

If the engine turns over at its normal speed but will not start—

1. 2JZ–GE engine only—Check that all the push–on connectors are tight. (For example, connections at the spark plugs, ignition coil and/or distributor)
2. If the connectors are O.K., the engine may be flooded because of repeated cranking. See “(b) Starting a flooded engine” for further instructions.

(b) Starting a flooded engine

If the engine will not start, your engine may be flooded because of repeated cranking.

If this happens, turn the key to “START” with the accelerator pedal held down. Keep the key and accelerator pedal so for 15 seconds and release them. Then try starting the engine with your foot off the accelerator pedal.

If the engine does not start after 15 seconds of cranking, release the key, wait a few minutes and try again.

If the engine still will not start, it needs adjustment or repair. Call a Toyota dealer or qualified repair shop for assistance.

NOTICE

Do not crank for more than 30 seconds at a time. This may overheat the starter and wiring systems.

(c) Jump starting

To avoid serious personal injury and damage to your vehicle which might result from battery explosion, acid burns, electrical burns, or damaged electronic components, these instructions must be followed precisely.

If you are unsure about how to follow this procedure, we strongly recommend that you seek the help of a competent mechanic or towing service.



CAUTION

Ⓡ Batteries contain sulfuric acid which is poisonous and corrosive. Wear protective safety glasses when jump starting, and avoid spilling acid on your skin, clothing, or vehicle.

Ⓡ If you should accidentally get acid on yourself or in you eyes, remove any contaminated clothing and flush the affected area with water for at least 15 minutes. Then get immediate medical attention. If possible, continue to apply water with a sponge or cloth while en route to the medical office.

Ⓡ The gas normally produced by a battery will explode if a flame or spark is brought near. Use only standardized cables and do not smoke or light a match while jump starting.

NOTICE

The battery used for boosting must be 12 V. Do not jump start unless you are sure that the booster battery is correct.

JUMP STARTING PROCEDURE

1. If the booster battery is installed in another vehicle, make sure the vehicles are not touching. Turn off all unnecessary lights and accessories.
2. If required, remove all the vent plugs from the booster and discharged batteries. Lay a cloth over the open vents on the batteries. (This helps reduce the explosion hazard, personal injuries and burns.)
3. If the engine in the vehicle with the booster battery is not running, start it and let it run for a few minutes. During jump starting, run the engine at about 2000 rpm with the accelerator pedal lightly depressed.

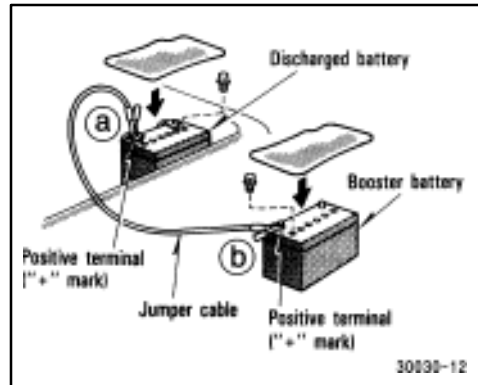

4. Make the cable connection in the order a, b, c, d.
 - a. Connect the clamp of the positive (red) jumper cable to the positive (+) terminal on the discharged battery.
 - b. Connect the clamp at the other end of the positive (red) jumper cable to the positive (+) terminal on the booster battery.

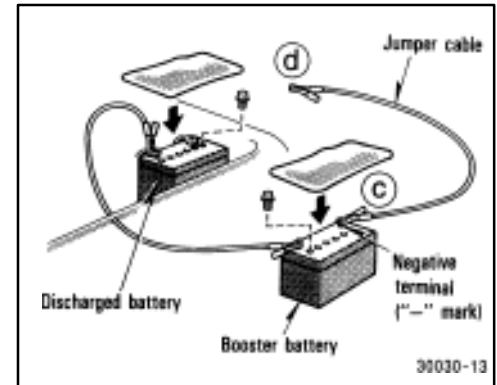

- c. Connect the clamp of the negative (black) jumper cable to the negative (-) terminal on the booster battery.
- d. Connect the clamp at the other end of the negative (black) jumper cable to a solid, stationary, unpainted, metallic point of the vehicle with the discharged battery.

The recommended connecting points are shown in the following illustrations:

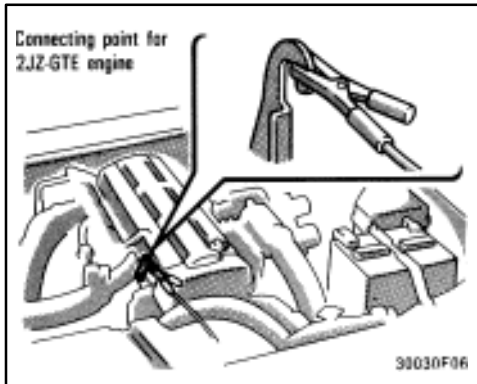
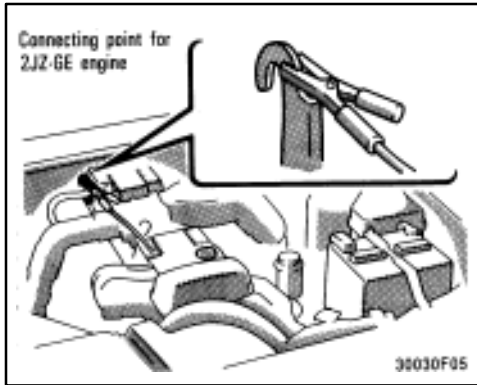

Do not connect the cable to or near any part that moves when the engine is cranked.



When making the connections, to avoid serious injury, do not lean over the battery or accidentally let the jumper cables or clamps touch anything except the correct battery terminals or the ground.

5. Start your engine in the normal way. After starting, run it at about 2000 rpm for several minutes with the accelerator pedal lightly depressed.
6. Carefully disconnect the cables in the exact reverse order: the negative cable and then the positive cable.
7. Carefully dispose of the battery cover cloths—they may now contain sulfuric acid.
8. If removed, replace all the battery vent plugs.

If the cause of your battery discharging is not apparent (for example, lights left on), you should have it checked.

If your engine stalls while driving

If your engine stalls while driving...

1. Reduce your speed gradually, keeping a straight line. Move cautiously off the road to a safe place.
2. Turn on your emergency flashers.
3. Try starting the engine again.

If the engine will not start, see "If your vehicle will not start".



If the engine is not running, the power assist for the brakes and steering will not work so steering and braking will be much harder than usual.

If your vehicle overheats

If your engine coolant temperature gauge indicates overheating, if you experience a loss of power, or if you hear a loud knocking or pinging noise, the engine has probably overheated. You should follow this procedure...

1. Pull safely off the road, stop the vehicle and turn on your emergency flashers. Put the transmission in "P" (automatic) or neutral (manual) and apply the parking brake. Turn off the air conditioning if it is being used.
2. If coolant or steam is boiling out of the radiator or reservoir, stop the engine. Wait until the steam subsides before opening the hood. If there is no coolant boiling over or steam, leave the engine running.



CAUTION

To help avoid personal injury, keep the hood closed until there is no steam. Escaping steam or coolant is a sign of very high pressure.

3. Visually check to see if the engine drive belt (fan belt) is broken or loose. Look for obvious coolant leaks from the radiator, hoses, and under the vehicle. However, note that water draining from the air conditioning is normal if it has been used.



CAUTION

When the engine is running, keep hands and clothing away from the moving fan and engine drive belts.

4. If the engine drive belt is broken or the coolant is leaking, stop the engine immediately. Call a Toyota dealer for assistance.
5. If the engine drive belt is O.K. and there are no obvious leaks, you may help the engine cool down more quickly by running it at about 1500 rpm for a few minutes with the accelerator pedal lightly depressed.
6. Check the coolant reservoir. If it is dry, add coolant to the reservoir while the engine is running. Fill it about half full.



CAUTION

Do not attempt to remove the radiator cap when the engine and radiator are hot. Serious injury could result from scalding hot fluid and steam blown out under pressure.

7. After the engine coolant temperature has cooled to normal, again check the coolant level in the reservoir. If necessary, bring it up to half full again. Serious coolant loss indicates a leak in the system. You should have it checked as soon as possible at your Toyota dealer.

If you have a flat tire—

1. Reduce your speed gradually, keeping a straight line. Move cautiously off the road to a safe place well away from the traffic. Avoid stopping on the center divider of a highway. Park on a level spot with firm ground.
2. Stop the engine and turn on your emergency flashers.
3. Firmly set the parking brake and put the transmission in “P” (automatic) or reverse (manual).
4. Have everyone get out of the vehicle on the side away from traffic.
5. Read the following instructions thoroughly.



CAUTION

When jacking, be sure to observe the following to reduce the possibility of personal injury:

- Ⓡ Follow jacking instructions.
- Ⓡ Use a jack only for lifting your vehicle during wheel changing.
- Ⓡ Never get beneath the vehicle when supported by a jack
- Ⓡ Do not start or run the engine while your vehicle is supported by a jack.

NOTICE

Do not continue driving with a deflated tire. Driving even a short distance can damage a tire beyond repair.

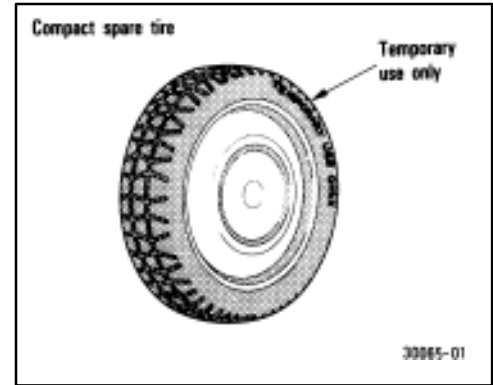

Compact spare tire

The compact spare tire is designed for temporary emergency use only.

The compact spare tire is identified by the distinctive wheel design and color and special wording “TEMPORARY USE ONLY” molded into the side wall of the tire.

The standard tire should be repaired and replaced as soon as possible.

To keep the compact spare tire noticeable, do not hide the wheel by a wheel cover or such.

The compact spare tire saves space in your luggage compartment, and its lighter weight helps to improve fuel economy and permits easier installation in case of a flat tire.

The compact spare tire can be used many times, if necessary. It has tread life of up to 4800 km (3000 miles) depending on road conditions and your driving habits. When tread wear indicators appear on the tire, replace the tire.

See also the tire section in Chapter 7-2 for details on the tread wear indicators and other service information.



- ⑥ **The compact spare tire was designed especially for your Toyota. Do not use it on any other vehicle.**
- ⑥ **Do not exceed 80 km/h (50 mph) when driving with the compact spare tire.**

NOTICE

Your ground clearance is reduced when the compact spare tire is installed so avoid driving over obstacles and drive slow on rough, unpaved roads and speed bumps. Also, do not attempt to go through an automatic car wash as the vehicle may get caught, resulting in damage.

—Required tools and spare tire

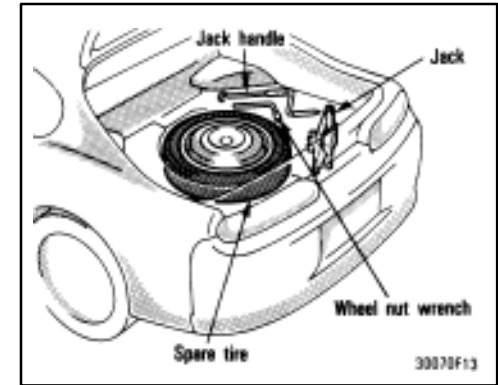

1. Get the wheel nut wrench, jack, jack handle and spare tire.

To prepare yourself for an emergency, you should familiarize yourself with the use of the jack, each of the tools and their storage locations.

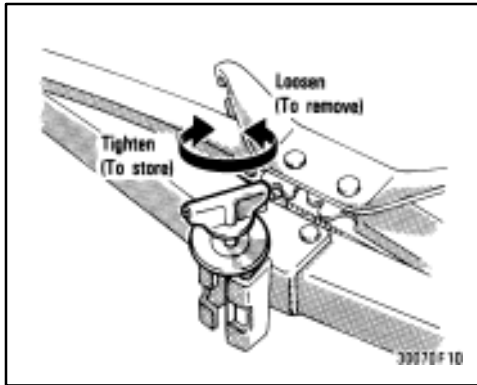

To remove the jack, loosen the bolt and remove it.

When storing the jack, secure it by following removal step in reverse order to prevent it from flying forward during a collision or sudden braking.

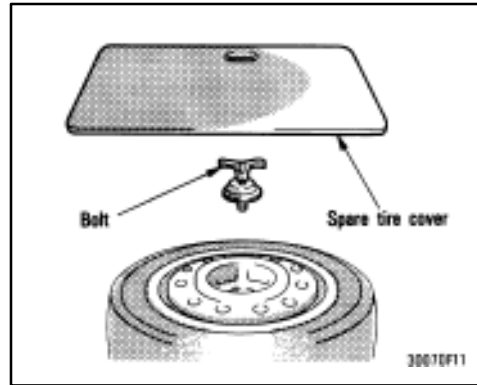

To remove the spare tire:

1. Remove the spare tire cover.
2. Loosen the bolt and remove it.

When storing the spare tire, put it in place with the outer side of the wheel facing up. Then secure the tire by repeating the above removal steps in reverse order to prevent it from flying forward during a collision or sudden braking.

—Blocking the wheel

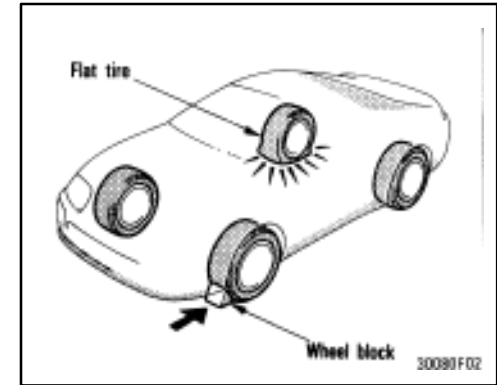

2. **Block the wheel diagonally opposite the flat tire to keep the vehicle from rolling when it is jacked up.**

When blocking the wheel, place a wheel block from the front for the front wheels or from the rear for the rear wheels.

—Removing wheel ornament

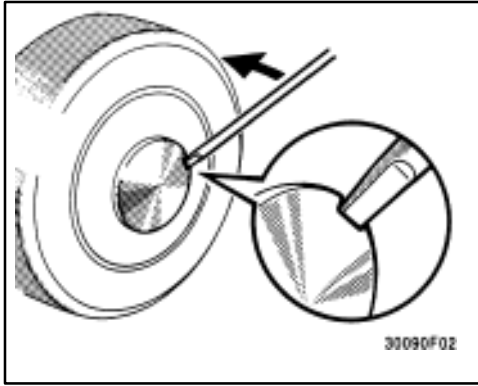

3. Remove the wheel ornament.

Pry off the wheel ornament, using the beveled end of the wheel nut wrench as shown.



Do not try to pull the ornament by hand. Take due care in handling the ornament to avoid unexpected personal injury.

—Loosening wheel nuts

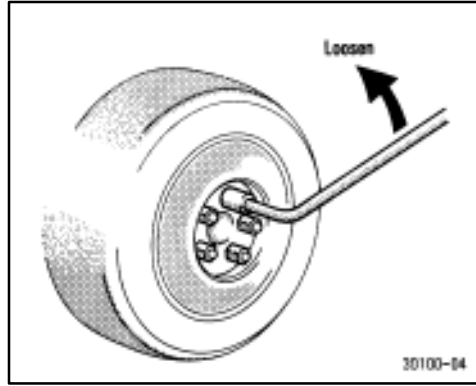

4. Loosen all the wheel nuts.

Always loosen the wheel nuts before raising the vehicle.

The nuts turn counterclockwise to loosen. To get maximum leverage, fit the wrench to the nut so that the handle is on the right side, as shown above. Grab the wrench near the end of the handle and pull up on the handle. Be careful that the wrench does not slip off the nut.

Do not remove the nuts yet—just unscrew them about one-half turn.

—Positioning the jack

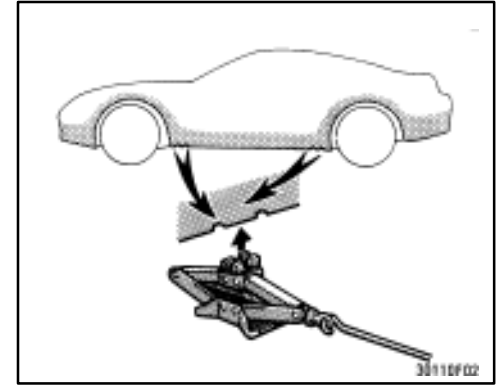

5. Position the jack at the correct jack points as shown

Make sure the jack is positioned on a level and solid place.

—Raising your vehicle

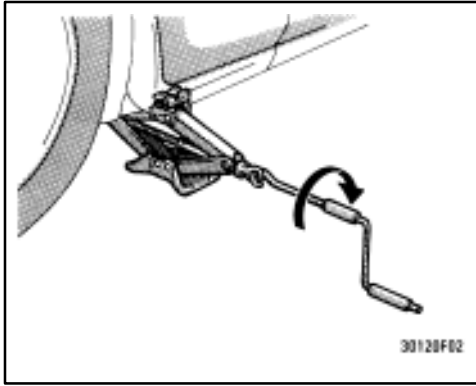

6. After making sure that no one is in the vehicle, raise it high enough so that the spare tire can be installed.

Remember you will need more ground clearance when putting in the spare tire than when removing the flat tire.

To raise the vehicle, insert the jack handle into the jack (it is a loose fit) and turn it clockwise. As the jack touches the vehicle and begins to lift, double-check that it is properly positioned.



Never get under the vehicle when the vehicle is supported by the jack alone.

—Changing wheels

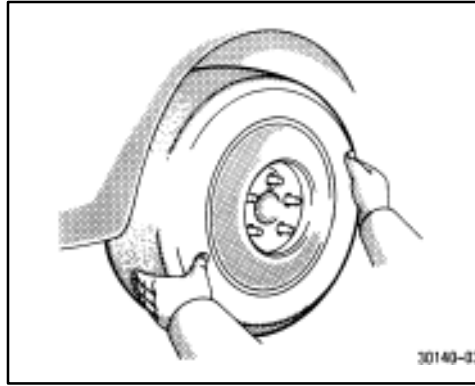

7. Remove the wheel nuts and change tires.

Lift the flat tire straight off and put it aside. Roll the spare wheel into position and align the holes in the wheel with the bolts. Then lift up the wheel and get at least the top bolt started through its hole. Wiggle the tire and press it back over the other bolts.



Before putting on wheels, remove any corrosion on the mounting surfaces with a wire brush or such. Installation of wheels without good metal-to-metal contact at the mounting surface can cause wheel nuts to loosen and eventually cause a wheel to come off while driving. Therefore after the first 1600 km (1000 miles), check to see that the wheel nuts are tight.

—Reinstalling wheel nuts

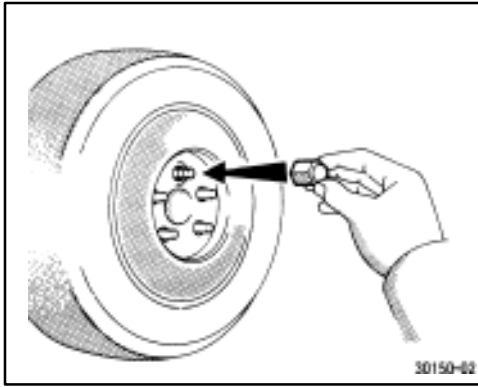

8. Reinstall all the wheel nuts finger tight.

Reinstall the wheel nuts and tighten them as much as you can by hand. Press back on the tire back and see if you can tighten them more.

—Lowering your vehicle

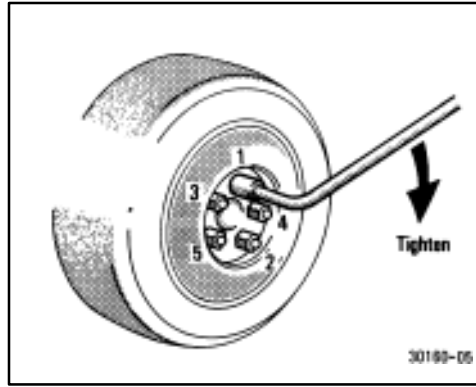

9. Lower the vehicle completely and tighten the wheel nuts.

Turn the jack handle counterclockwise to lower the vehicle.

Use only the wheel nut wrench to tighten the nuts. Do not use other tools or any additional leverage other than your hands, such as a hammer, pipe or your foot. Make sure the wrench is securely engaged over the nut.

Tighten each nut a little a time in the order shown. Repeat the process until all the nuts are tight.

—Reinstalling wheel ornament

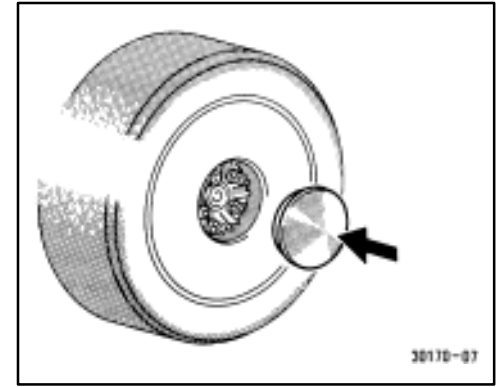

10. Reinstall the wheel ornament.

Put the wheel ornament into position and then tap it firmly with the side or heel of your hand to snap it into place.



Take due care in handling the ornament to avoid unexpected personal injury.

—After changing wheels

11. Check the air pressure of the re-placed tire.

Adjust the air pressure to the specification designated in Part 8. If the pressure is lower, drive slowly to the nearest service station and fill to the correct pressure.

Do not forget to reinstall the tire inflation valve cap as dirt and moisture could get into the valve core and possibly cause air leakage. If the cap is missing, have a new one put on as soon as possible.

12. Restow all the tools, jack and flat tire securely.

As soon as possible after changing wheels, tighten the wheel nuts to the torque specified in Part 8 with a torque wrench, have a technician repair the flat tire and replace the spare tire with it.



CAUTION

Before driving, make sure all the tools, jack and flat tire are securely in place in their storage location to reduce the possibility of personal injury during a collision or sudden braking.

If your vehicle needs to be towed—

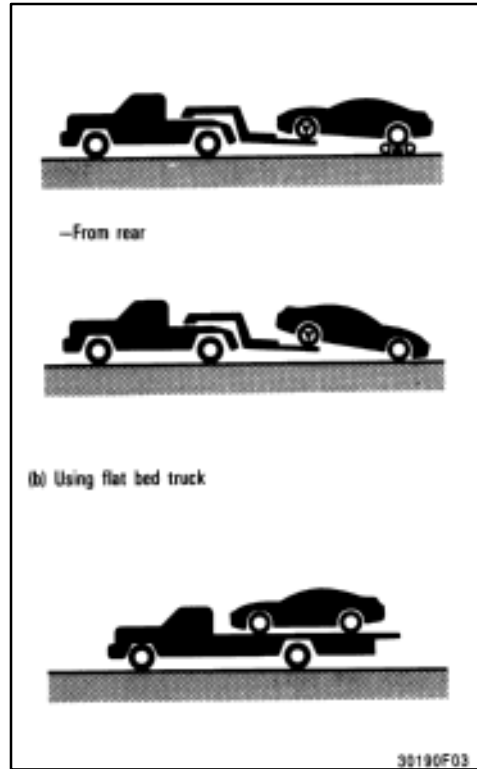

If towing is necessary, we recommend you to have it done by your Toyota dealer or a commercial tow truck service. In consultation with them, have your vehicle towed using either (a) or (b).

Only when you cannot receive a towing service from a Toyota dealer or commercial tow truck service, tow your vehicle carefully in accordance with the instructions given in “—Emergency towing” in this part.

Proper equipment will help ensure that your vehicle is not damaged while being towed. Commercial operators are generally aware of the state/provincial and local laws pertaining to towing.

Your vehicle can be damaged if it is towed incorrectly. Although most operators know the correct procedure, it is possible to make a mistake. To avoid damage to your vehicle, make sure the following few precautions are observed. If necessary, show this page to the tow truck driver.

TOWING PRECAUTIONS:

Use a safety chain system for all towing, and abide by the state/provincial and local laws. The wheels and axle on the ground must be in good condition. If they are damaged, use a towing dolly.

**(a) Towing with wheel lift type truck
From front—**

- ® Manual transmission:
We recommend using a towing dolly under the front wheels. If you do not use a towing dolly, place the ignition key in the “ACC” position and put the transmission in neutral.
- ® Automatic transmission:
Use a towing dolly under the front wheels.

NOTICE

Never tow a vehicle with an automatic transmission from the rear with the front wheels on the ground, as this may cause serious damage to the transmission.

From rear—Place the ignition key in the “ACC” position.

NOTICE

◀ *When lifting wheels, take care to ensure adequate ground clearance for towing at the opposite end of the raised vehicle. Otherwise, the bumper and/or underbody of the towed vehicle will be damaged during towing.*

◀ *Do not tow with the key removed or in the “LOCK” position, as the steering lock mechanism is not strong enough to hold the front wheels straight while towing.*

(b) Using flat bed truck

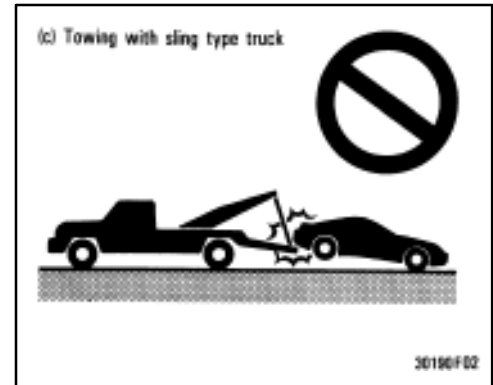

(c) Towing with sling type truck

NOTICE

Do not tow with sling type truck, either from the front or rear. This may cause body damage.

—Emergency towing

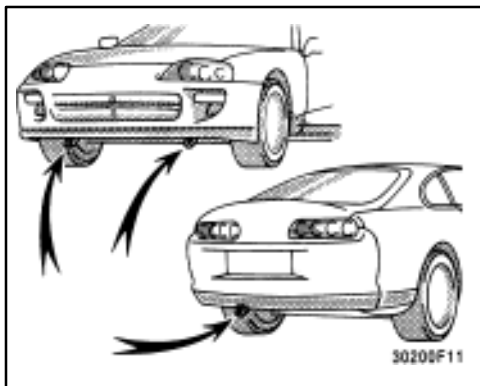

If towing is necessary, we recommend you to have it done by your Toyota dealer or a commercial tow truck service.

If towing service is not available in an emergency, your vehicle may be temporarily towed by a cable or chain secured to either emergency towing eyelet under the vehicle. Use extreme caution when towing vehicle.

A driver must be in the vehicle to steer it and operate the brakes.

Towing in this manner may be done only on hard-surfaced roads for a short distance and at low speeds. Also, the wheels, axles, drive train, steering and brakes must all be in good condition.



CAUTION

Use extreme caution when towing vehicles. Avoid sudden starts or erratic driving maneuvers which would place excessive stress on the emergency towing eyelet and towing cable or chain. The eyelet and towing cable or chain may break and cause serious injury or damage.

NOTICE

Use only a cable or chain specifically intended for use in towing vehicles. Securely fasten the cable or chain to the towing eyelet provided.

Before towing, release the parking brake and put the transmission in neutral (manual) or “N” (automatic). The key must be in “ACC” (engine off) or “ON” (engine running).



CAUTION

If the engine is not running, the power assist for the brakes and steering will not work so steering and braking will be much harder than usual.

If you cannot shift automatic transmission selector lever

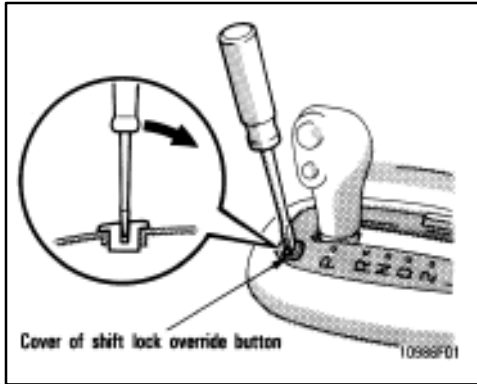

If you cannot shift the selector lever out of “P” position to other positions even though the brake pedal is depressed, use the shift lock override button as follows:

1. Turn the ignition key to “LOCK” position. Make sure the parking brake is on.
2. Pry up the cover with a flat-bladed screwdriver or equivalent.

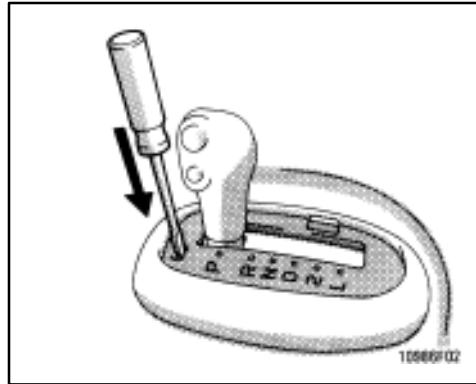

3. Insert the screwdriver or equivalent into the hole to push down the shift lock override button. You can shift out of “P” position only while pushing the button.
4. Shift into “N” position.
5. Insert the cover.
6. Start the engine. For your safety, keep the brake pedal depressed.

Be sure to have the system checked by your Toyota dealer as soon as possible.

If you lose your keys

Many Toyota dealers can make a new key if you can give them the key number.

See the suggestion given in “Keys” in Chapter 1–2.

If your keys are locked in the vehicle and you cannot get a duplicate, many Toyota dealers can still open the door for you, using their special tools. If you must break a window to get in, we suggest breaking the smallest side window because it is the least expensive to replace. Be extremely cautious to avoid cuts from the glass.

Part 5

CORROSION PREVENTION AND APPEARANCE CARE

- ® Protecting your Toyota from corrosion
- ® Washing and waxing your Toyota
- ® Cleaning the interior

Protecting your Toyota from corrosion

Toyota, through its diligent research, design and use of the most advanced technology available, has done its part to help prevent corrosion and has provided you with the finest quality vehicle construction. Now, it is up to you. Proper care of your Toyota can help ensure long-term corrosion prevention.

The most common causes of corrosion to your vehicle are:

- ® The accumulation of road salt, dirt and moisture in hard-to-reach areas under the vehicle.
- ® Chipping of paint, or undercoating caused by minor accidents or by stones and gravel.

Care is especially important if you live in particular areas or operate your vehicle under certain environmental conditions:

- ® Road salt or dust control chemicals will accelerate corrosion, as will the presence of salt in the air near the sea-coast or in areas of industrial pollution.
- ® High humidity accelerates corrosion especially when temperatures range just above the freezing point.

- ® Wetness or dampness to certain parts of your vehicle for an extended period of time, may cause corrosion even though other parts of the vehicle may be dry.
- ® High temperatures will cause corrosion to those components of the vehicle which are prevented from quick-drying due to lack of proper ventilation.

The above signifies the necessity to keep your vehicle, particularly the underside, as clean as possible and to repair any damage to paint or protective coatings as soon as possible.

To help prevent corrosion on your Toyota, follow these guidelines:

Wash your vehicle frequently: It is, of course, necessary to keep your vehicle clean by regular washing, but to prevent corrosion, the following points should be observed:

- ® If you drive on salted roads in the winter or if you live near the ocean, you should hose off the undercarriage at least once a month to minimize corrosion.

- ® High pressure water or steam is effective for cleaning the vehicle's underside and wheel housings. Pay particular attention to these areas as it is difficult to see all the mud and dirt. It will do more harm than good to simply wet the mud and debris without removing them. The lower edge of doors, rocker panels and frame members have drain holes which should not be allowed to clog with dirt as trapped water in these areas can cause corrosion.
- ® Wash the underside of the vehicle thoroughly when winter is over.

See "Washing and waxing your Toyota" for more tips.

Check the condition of your vehicle's paint and trim. If you find any chips or scratches in the paint, touch them up immediately to prevent corrosion from starting. If the chips or scratches have gone through the bare metal, have a qualified bodyshop make the repair.

Check the interior of your vehicle. Water and dirt can accumulate under the floor mats and could cause corrosion. Occasionally check under the mats to make sure the area is dry. Be particularly careful when transporting chemicals, cleansers, fertilizers, salt, etc; these should be transported in proper containers. If a spill or leak should occur, immediately clean and dry the area.

Use mud shields on your wheels. If you drive on salted or gravel roads, mud shields help protect your vehicle. Full-size shields, which come as near to the ground as possible, are the best. We recommend that the fittings and the area where the shields are installed be treated to resist corrosion. Your Toyota dealer will be happy to assist in supplying and installing the shields if they are recommended for your area.

Do not park your vehicle in a damp, poorly ventilated garage. If you wash your vehicle in the garage, or if you drive it in covered with water or snow, your garage may be so damp it will cause corrosion. Even if your garage is heated, a wet vehicle can corrode if the ventilation is poor.

Washing and waxing your Toyota

Washing your Toyota by hand

Work in the shade and wait until the vehicle body is not hot to the touch.



When cleaning under floor or chassis, be careful not to injure your hands.

1. Rinse off loose dirt with a hose. Remove any mud or road salt from the underside of the vehicle or in the wheel wells.
2. Wash with a mild car-wash soap, mixed according to the manufacturer's instructions. Use a soft cotton mitt and keep it wet by dipping it frequently into the wash water. Do not rub hard—let the soap and water remove the dirt.

Aluminum wheels: Use only a mild soap or neutral detergent.

Plastic bumpers: Wash carefully. Do not scrub with abrasive cleaners. The bumper faces are soft.

Road tar: Remove with turpentine or cleaners that are marked safe for painted surfaces.

NOTICE

Do not use gasoline or strong solvents, which may be toxic or cause damage.

3. Rinse thoroughly — dried soap can cause streaking. In hot weather you may need to rinse each section right after you wash it.
4. To prevent water spots, dry the vehicle using a clean soft cotton towel. Do not rub or press hard — you might scratch the paint.

Automatic car wash

Your vehicle may be washed in an automatic car wash, but remember that the paint can be scratched by some type of brushes, unfiltered washing water, or the washing process itself. Scratching reduces paint durability and gloss, especially on darker colors. Also, automatic car wash equipment may interfere with a damage the rear spoiler if your vehicle is equipped with one. The manager of the car wash should be able to advise you whether the process is safe for the paint on your vehicle or the vehicle body itself.

NOTICE

To prevent damage to the antenna, make sure it is retracted before driving your Toyota through an automatic car wash.

Waxing your Toyota

Polishing and waxing is recommended to maintain the original beauty of your Toyota's finish.

1. Always wash and dry the vehicle before you begin waxing, even if you are using a combined cleaner and wax.
2. Use a good quality polish and wax. If the finish has become extremely weathered, use a car-cleaning polish, followed by a separate wax. Carefully follow the manufacturer's instructions and precautions. Be sure to polish and wax the chrome trim as well as the paint.
3. Wax the vehicle again when water does not bead but remains on the surface in large patches.

NOTICE

Always remove the plastic bumpers if your vehicle is re-painted and placed in a high heat paint waxing booth. High temperatures could damage the bumpers.

Cleaning the interior



CAUTION

Do not wash the vehicle floor with water, or allow water to get into the floor when cleaning the vehicle interior or exterior. Water may get into audio components or other electrical components above or under the floor carpet (or mat) and cause a malfunction; and it may cause body corrosion.

Vinyl interior

The vinyl upholstery may be easily cleaned with a mild soap or detergent and water.

First vacuum over the upholstery to remove loose dirt. Then, using a sponge or soft cloth, apply the soap solution to the vinyl. After allowing it to soak in for a few minutes to loosen the dirt, remove the dirt and wipe off the soap with a clean damp cloth. If all the dirt does not come off, repeat the procedure. Commercial foaming-type vinyl cleaners are also available which work well. Follow the manufacturer's instructions.

NOTICE

Do not use solvent, thinner, gasoline or window cleaner on the interior.

Carpets

Use a good foam-type shampoo to clean the carpets.

Begin by vacuuming thoroughly to remove as much dirt as possible. Several types of foam cleaners are available; some are in aerosol cans and others are powders or liquids which you mix with water to produce a foam. To shampoo the carpets, use a sponge or brush to apply the foam. Rub in overlapping circles.

Do not apply water – the best results are obtained by keeping the carpet as dry as possible. Read the shampoo instructions and follow them closely.

Seat belts

The seat belts may be cleaned with mild soap and water or with lukewarm water.

Use a cloth or sponge. As you are cleaning, check the belts for excessive wear, fraying, or cuts.

NOTICE

Do not use dye or bleach on the belts—it may weaken them.

Windows

The windows may be cleaned with any household window cleaner.

NOTICE

When cleaning the inside of the windows, be careful not to scratch or damage the heater wires on the rear window.

Air conditioning control panel, car audio, instrument panel, console panel, and switches

Use a soft damp cloth for cleaning.

Soak a clean soft cloth in water or lukewarm water then lightly wipe off any dirt.

NOTICE

- ◀ **Do not use organic substances (solvents, kerosene, alcohol, gasoline, etc.) or alkaline or acidic solutions. These chemicals can cause discoloring, staining or peeling of the surface.**
- ◀ **If you use cleaners or polishing agents, make sure their ingredients do not include the substances mentioned above.**
- ◀ **If you use a liquid car freshener, do not apply the liquid onto the vehicle's interior surfaces. It may contain the ingredients mentioned above. Immediately clean any spill using the method mentioned above.**

Leather Interior

The leather upholstery may be cleaned with neutral detergent for wool.

Remove dirt using a soft cloth dampened with 5 % Solution of neutral detergent for wool. Then thoroughly wipe off all traces of detergent with a clean damp cloth.

After cleaning or whenever any part of the leather gets wet, dry with a soft clean cloth. Allow the leather to dry in a ventilated shaded area.

NOTICE

- ◀ **If a stain should fail to come out with a neutral detergent, apply a cleaner that does not contain an organic solvent.**
- ◀ **Never use organic substances such as benzene, alcohol or gasoline, or alkaline or acid solutions for cleaning the leather as these could cause discoloring.**
- ◀ **Use of a nylon brush or synthetic fiber cloth, etc. may scratch the fine grained surface of the leather.**
- ◀ **Mildew may develop on soiled leather upholstery. Be especially careful to avoid oil spots. Try to keep your upholstery always clean.**
- ◀ **Long exposure to direct sunlight may cause the leather surface to harden and shrink. Keep your vehicle in a shaded area, especially in the summer.**
- ◀ **The interior of your vehicle is apt to heat up on hot summer days, so avoid placing on the upholstery items made of vinyl or plastic or containing wax as these tend to stick to leather when warm.**

◀ **Improper cleaning of the leather upholstery could result in discoloration or staining.**

If you have any questions about the cleaning of your Toyota, your local Toyota dealer will be pleased to answer them.

Part 6

VEHICLE MAINTENANCE AND CARE

- ® Maintenance requirements
- ® General maintenance
- ® Does your vehicle need repairing?

For scheduled maintenance information, please refer to the separate “Owner’s Manual Supplement/Maintenance Schedule”.

Maintenance requirements

Your Toyota vehicle has been designed for fewer maintenance requirements with longer service intervals to save both your time and money. However, each regular maintenance, as well as day-to-day care, is more important than ever before to ensure smooth, trouble-free, safe, and economical drivings.

It is the owner’s responsibility to make sure the specified maintenance, including general maintenance service, is performed. Note that both the new vehicle and emission control system warranties specify that proper maintenance and care must be performed. See Owner’s Guide, Owner’s Manual Supplement or Warranty Booklet for complete warranty information.

General maintenance

General maintenance items are those day-to-day care practices that are important to your vehicle for proper operation. It is the owner’s responsibility to ensure that the general maintenance items are performed regularly.

These checks or inspections can be done either by yourself or a qualified technician, or if you prefer, your Toyota dealer will be pleased to do them at a nominal cost.

Scheduled maintenance

The scheduled maintenance items listed in the “Owner’s Manual Supplement” are those required to be serviced at regular intervals.

For details of your maintenance Schedule, read the separate “Owner’s Manual Supplement/Maintenance Schedule”.

It is recommended that any replacement parts used for maintenance or for the repair of the emission control system be Toyota supplied.

The owner may elect to use non-Toyota supplied parts for replacement purposes without invalidating the emission control system warranty. However, use of replacement parts which are not of equivalent quality may impair the effectiveness of the emission control systems.

You may also elect to have maintenance, replacement, or repair of the emission control devices and system performed by any automotive repair establishment or individual without invalidating this warranty. See Owner’s Guide, Owner’s Manual Supplement or Warranty Booklet for complete warranty information.

Where to go for service?

Toyota technicians are well-trained specialists and are kept up to date with the latest service information through technical bulletins, service tips, and in-dealership training programs. They learn to work on Toyotas before they work on your vehicle, rather than while they are working on it.

You can be confident that your Toyota dealer's service department performs the best job to meet the maintenance requirements on your vehicle—reliably and economically.

Your copy of the repair order is proof that all required maintenance has been performed for warranty coverage. And if any problems should arise with your vehicle while under warranty, your Toyota dealer will promptly take care of it. Again, be sure to keep a copy of the repair order for any service performed on your Toyota.

What about do-it-yourself maintenance?

Many of the maintenance items are easy to do yourself if you have a little mechanical ability and a few basic automotive tools. Simple instructions for how to perform them are presented in Part 7.

If you are a skilled do-it-yourself mechanic, the Toyota service manuals are recommended. Please be aware that do-it-yourself maintenance can affect your warranty coverage. See Owner's Guide, Owner's Manual Supplement or Warranty Booklet for the details.

General maintenance

Listed below are the general maintenance items that should be performed as frequently as specified. In addition to checking the items listed, if you notice any unusual noise, smell or vibration, you should investigate the cause or take your vehicle to your Toyota dealer or a qualified service shop immediately. It is recommended that any problem you notice be brought to the attention of your dealer or the qualified service shop for their advice.



Make these checks only where adequate ventilation can be obtained if you run the engine.

OUTSIDE THE VEHICLE

Items listed below should be performed from time to time, unless otherwise specified.

Tire pressure

Check the pressure with a gauge every two weeks, or at least once a month. See Chapter 7-2 for additional information.

Tire surface and wheel nuts

Check the tires carefully for cuts, damage or excessive wear. See Chapter 7–2 for additional information. When checking the tires, make sure no nuts are missing, and check the nuts for looseness. Tighten them if necessary.

Fluid leaks

Check underneath for leaking fuel, oil, water or other fluid after the vehicle has been parked for a while. If you smell fuel fumes or notice any leak, have the cause found and corrected immediately.

Doors and engine hood

Check that all doors including back door operate smoothly and all latches lock securely. Make sure the engine hood secondary latch secures the hood from opening when the primary latch is released.

INSIDE THE VEHICLE

Items listed below should be checked regularly, e.g. while performing periodic services, cleaning the vehicle, etc.

Lights

Make sure the headlights, stop lights, tail lights, turn signal lights, and other lights are all working. Check headlight aim.

Service reminder indicators and warning buzzers

Check that all service reminder indicators and warning buzzers function properly.

Steering wheel

Be alert for changes in steering condition, such as hard steering or strange noise.

Seats

Check that all front seat controls such as seat adjusters, seatback recliner, etc. operate smoothly and that all latches lock securely in any position. For folding-down rear seatbacks, check that the latches lock securely. Make sure the front headrests are firmly secured.

Seat belts

Check that the seat belt system such as buckles, retractors and anchors operate properly and smoothly. Make sure the belt webbing is not cut, frayed, worn or damaged.

Accelerator pedal

Check the pedal for smooth operation and uneven pedal effort or catching.

Clutch pedal

Check the pedal for smooth operation.

Brake pedal

Check the pedal for smooth operation and that the pedal has the proper clearance. Check the brake booster function.

Brakes

At a safe place, check that the brakes do not pull to one side when applied.

Parking brake

Check that the lever has the proper travel and that, on a safe incline, your vehicle is held securely with only the parking brake applied.

Automatic transmission “Park” mechanism

Check the lock release button of the selector lever for proper and smooth operation. On a safe incline, check that your vehicle is held securely with the selector lever in “P” position and all brakes released.

IN THE ENGINE COMPARTMENT

Items listed below should be checked from time to time , e.g. each time when refueling.

Washer fluid

Make sure there is sufficient fluid in the tank. See Chapter 7–3 for additional information.

Engine coolant level

Make sure the coolant level is between the “FULL” and “LOW” lines on the see-through reservoir when the engine is cold. See Chapter 7–2 for additional information.

Battery electrolyte level

Make sure the electrolyte level of all battery cells is correct. Add only distilled water when replenishing. See Chapter 7–3 for additional information.

Brake fluid level

Make sure the brake fluid level is correct. See Chapter 7–2 for additional information.

Engine oil level

Check the level on the dipstick with the engine turned off and the vehicle parked on a level spot. See Chapter 7–2 for additional information.

Power steering fluid level

Check the level on the dipstick. The level should be in the “HOT” or “COLD” range depending on the fluid temperature. See Chapter 7–2 for additional information.

Exhaust system

If you notice any change in the sound of the exhaust or smell exhaust fumes, have the cause located and corrected immediately. (See engine exhaust cautions in Part 2.)

Does your vehicle need repairing?

Be on the alert for changes in performance, sounds, and visual tip-offs that indicate service is needed. Some important clues are as follows:

- Ⓡ Engine missing, stumbling, or pinging
- Ⓡ Appreciable loss of power
- Ⓡ Strange engine noises
- Ⓡ A leak under the vehicle (however, water dripping from the air conditioning after use is normal.)
- Ⓡ Change in exhaust sound (This may indicate a dangerous carbon monoxide leak. Drive with the windows open and have the exhaust system checked immediately.)
- Ⓡ Flat-looking tire; excessive tire squeal when cornering; uneven tire wear
- Ⓡ Vehicle pulls to one side when driving straight on a level road
- Ⓡ Strange noises related to suspension movement
- Ⓡ Loss of brake effectiveness; spongy feeling brake or clutch pedal; pedal almost touches floor; vehicle pulls to one side when braking
- Ⓡ Engine coolant temperature continually higher than normal

If you notice any of these clues, take your vehicle to your Toyota dealer as soon as possible. It probably needs adjustment or repair.



Do not continue driving with the vehicle unchecked. It could result in serious vehicle damage and possibly personal injury.

Part 7

DO-IT-YOURSELF MAINTENANCE—

Chapter 7-1

Introduction

- Ⓜ [Engine compartment overview](#)
- Ⓜ [Fuse locations](#)
- Ⓜ [Do-it-yourself service precautions](#)
- Ⓜ [Parts and tools](#)

Engine compartment overview (2JZ-GE engine)

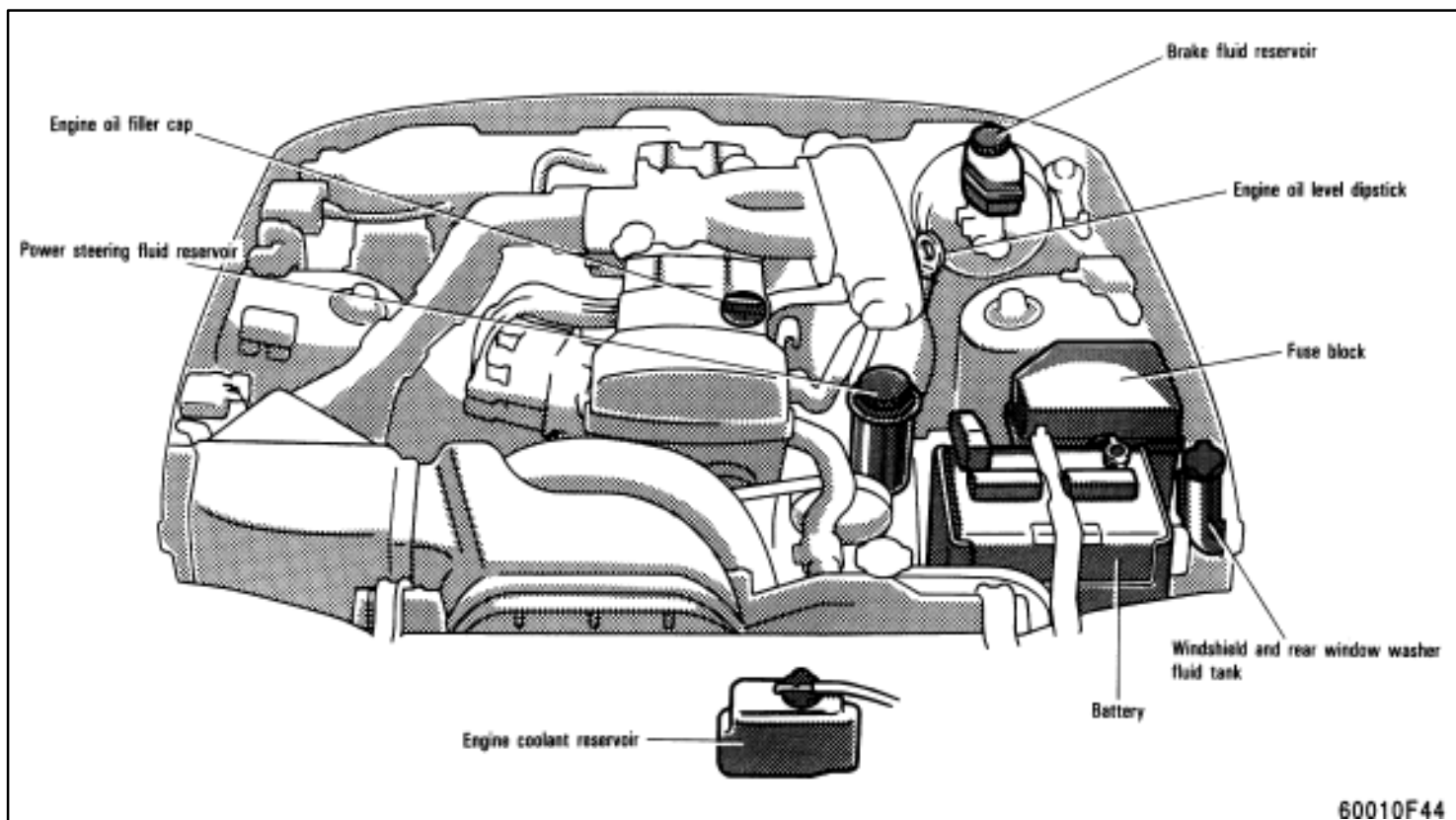

60010F44

Engine compartment overview (2JZ-GTE engine)

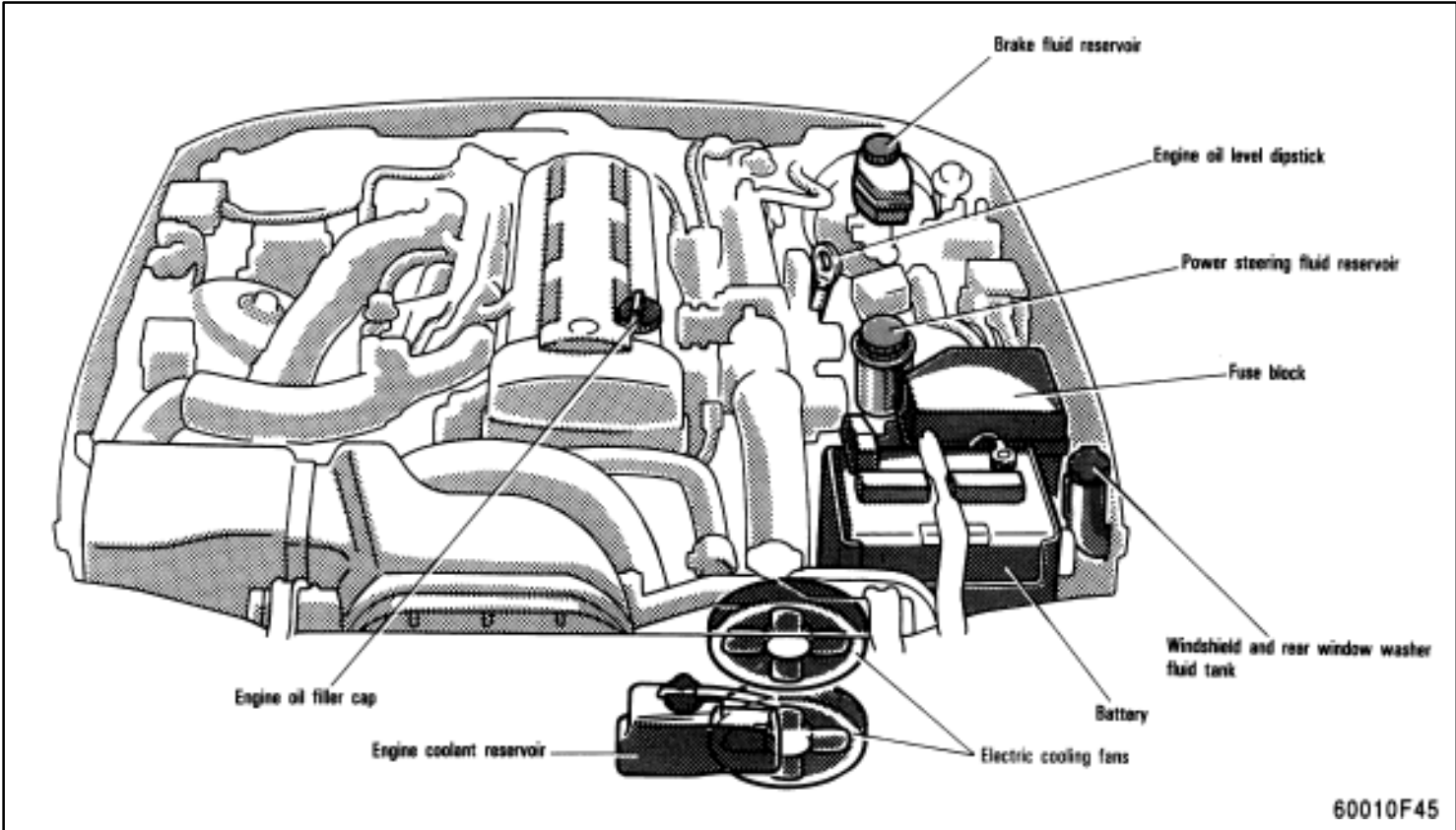

Fuse locations

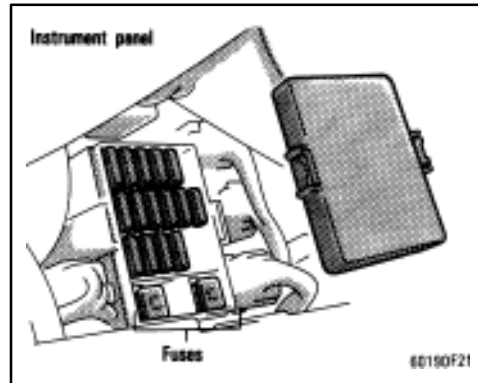
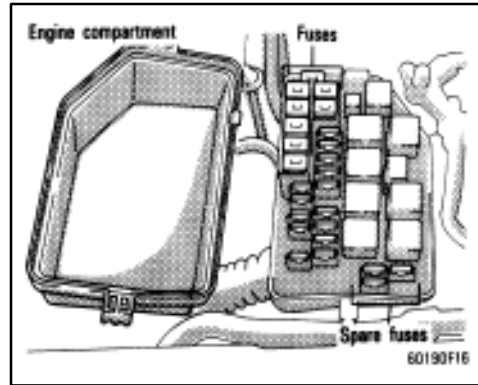
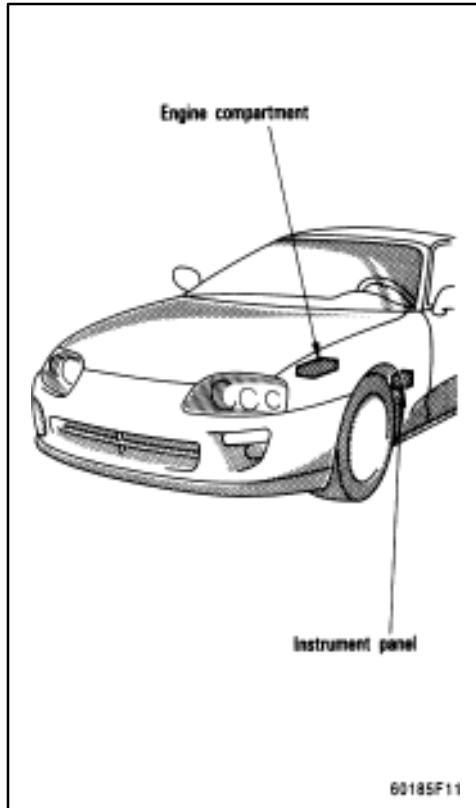

Do-it-yourself service precautions

If you perform maintenance by yourself, be sure to follow the correct procedure given in this part.

You should be aware that improper or incomplete servicing may result in operating problems.

Performing do-it-yourself maintenance during the warranty period may affect your warranty coverage. Read the separate Toyota Warranty statement for details and suggestions.

This part gives instructions only for those items that are relatively easy for an owner to perform. As explained in Part 6, there are still a number of items that must be done by a qualified technician with special tools.

For information on tools and parts for do-it-yourself maintenance, see "Parts and tools".

Utmost care should be taken when working on your vehicle to prevent accidental injury. Here are a few precautions that you should be especially careful to observe:



CAUTION

- Ⓢ When the engine is running, keep hands, clothing, and tools away from the moving fan and engine drive belts. (Removing rings, watches, and ties is advisable.)
- Ⓢ Right after driving, the engine compartment—the engine, radiator, exhaust manifold, power steering fluid reservoir and spark plug boots, etc.—will be hot. So be careful not to touch them. Oil, fluids and spark plugs may also be hot.
- Ⓢ If the engine is hot, do not remove the radiator cap or loosen the drain plugs to prevent burning yourself.
- Ⓢ Do not smoke, cause sparks or allow open flames around fuel or the battery. Their fumes are flammable.
- Ⓢ Be extremely cautious when working on the battery. It contains poisonous and corrosive sulfuric acid.
- Ⓢ Do not get under your vehicle with just the body jack supporting it. Always use automotive jack stands or other solid supports.

- Ⓢ Be sure that the ignition is off if you work near the electric cooling fans or radiator grille. With the ignition on, the electric cooling fans will automatically start to run if the engine coolant temperature is high and/or the air conditioning is on.
- Ⓢ Use eye protection whenever you work on or under you vehicle where you may be exposed to flying or falling material, fluid spray, etc.
- Ⓢ Used engine oil contains potentially harmful contaminants which may cause skin disorders such as inflammation or skin cancer, so care should be taken to avoid prolonged and repeated contact with it. To remove used engine oil from your skin, wash thoroughly with soap and water.
- Ⓢ Do not leave used oil within the reach of children.

- Ⓢ Dispose of used oil and filter only in a safe and acceptable manner. Do not dispose of used oil and filter in household trash, in sewers or onto the ground. Call your dealer or a service station for information concerning recycling or disposal.

NOTICE

- ◀ Remember that battery and ignition cable carry high currents or voltages. Be careful of accidentally causing a short circuit.
- ◀ Add only demineralized or distilled water to fill the radiator. And if you spill some of the coolant, be sure to wash it off with water to prevent it from damaging the parts or paint.
- ◀ Do not overfill automatic transmission fluid, or the transmission could be damaged.
- ◀ Do not drive with the air cleaner filter removed, or excessive engine wear could result. Also backfiring could cause a fire in the engine compartment.

◀ **Be careful not to scratch the glass surface with the wiper frame.**

◀ **When closing the engine hood, check to see that you have not forgotten any tools, rags, etc.**

Parts and tools

Here is a list of parts and tools you will need on performing do-it-yourself maintenance. Remember all Toyota parts are designed in metric sizes, so your tools must be metric.

Checking the engine oil level

Parts (if level is low):

- ® Engine oil API SH, “Energy–Conserving II” multigrade or ILSAC multigrade having viscosity proper for your climate

Tools:

- ® Rag or paper towel
- ® Funnel (only for adding oil)

Checking the engine coolant level

Parts (if level is low):

- ® Ethylene–glycol antifreeze
- ® Demineralized or distilled water

Tools:

- ® Funnel (only for adding coolant)

Checking brake fluid

Parts (if level is low):

- ® SAE J1703 or FMVSS No. 116 DOT 3 brake fluid

Tools:

- ® Rag or paper towel
- ® Funnel (only for adding fluid)

Checking power steering fluid

Parts (if level is low):

- ® Automatic transmission fluid DEX-
RON®II or III

Tools:

- ® Rag or paper towel
- ® Funnel (only for adding fluid)

Checking battery condition

Non–maintenance batteries—

Tools:

- ® Warm water
- ® Baking soda
- ® Grease
- ® Conventional wrench (for terminal clamp bolts)

Maintenance type batteries—

Parts (if level is low):

- ® Distilled water

Tools:

- ® Warm water
- ® Baking soda

- ® Grease
- ® Conventional wrench (for terminal clamp bolts)
- ® Coin (for vent plugs)
- ® Funnel (only for adding distilled water)

Checking and replacing fuses

Parts (if replacement is necessary):

- ® Fuse with same amperage rating as original

Adding washer fluid

Parts:

- ® Water
- ® Washer fluid containing antifreeze (for winter use)

Tools:

- ® Funnel

Replacing light bulbs

Parts:

- ® Bulb with same number and wattage rating as original (See charts in “Replacing light bulbs” in Chapter 7–3.)

Tools:

- ® Screwdriver

Part 7

DO-IT-YOURSELF MAINTENANCE—

Chapter 7-2

Engine and Chassis

- ◀ Checking the engine oil level
- ◀ Checking the engine coolant level
- ◀ Checking brake fluid
- ◀ Checking power steering fluid
- ◀ Checking tire pressure
- ◀ Checking and replacing tires
- ◀ Rotating tires
- ◀ Installing snow tires and chains
- ◀ Replacing wheels
- ◀ Aluminum wheel precautions

Checking the engine oil level

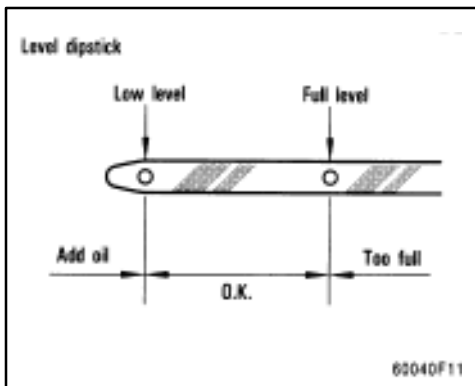

With the engine at operating temperature and turned off, check the oil level on the dipstick.

1. To get a true reading, the vehicle should be on a level spot. After turning off the engine, wait a few minutes for the oil to drain back into the bottom of the engine.
2. Pull out the dipstick, and wipe it clean with a rag.
3. Reinsert the dipstick—push it in as far as it will go, or the reading will not be correct.
4. Pull the dipstick out and look at the oil level on the end.

If the oil level is below or only slightly above the low level, add engine oil of the same type as already in the engine.

Remove the oil filter cap and add engine oil in small quantities at a time, checking the dipstick.

The approximate quantity of oil needed to fill between the low level and the full level on the dipstick is indicated below for reference.

When the level reaches within the correct range, install the filler cap hand-tight.

Oil quantity, L (qt., Imp. qt.): 1.5 (1.6, 1.3)

NOTICE

- / ***Avoid overfilling, or the engine could be damaged.***
- / ***Check the oil level on the dipstick once again after adding the oil.***

ENGINE OIL SELECTION

2JZ-GE engine—Use API SH, “Energy-Conserving II” multigrade engine oil or ILSAC multigrade engine oil.

Recommended viscosity (SAE):

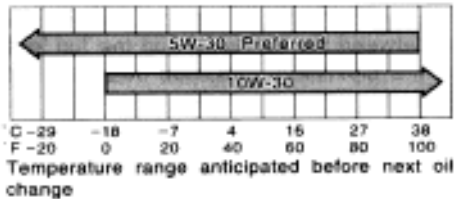

L70010

SAE 5W-30 is the best choice for your vehicle, for good fuel economy, and good starting in cold weather.

If you use SAE 10W-30 engine oil in extremely low temperatures, the engine may become difficult to start, so SAE 5W-30 engine oil is recommended.

2JZ-GTE engine—Use API SH, “Energy-Conserving II” multigrade engine oil or ILSAC multigrade engine oil.

Recommended viscosity (SAE):

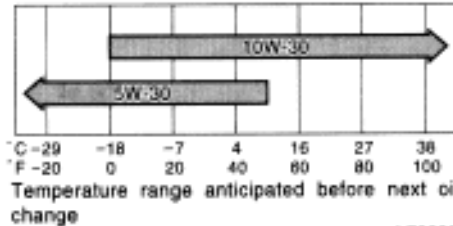

Temperature range anticipated before next oil change

L70009

If you use SAE 10W-30 engine oil in extremely low temperatures, the engine may become difficult to start, so SAE 5W-30 engine oil is recommended.

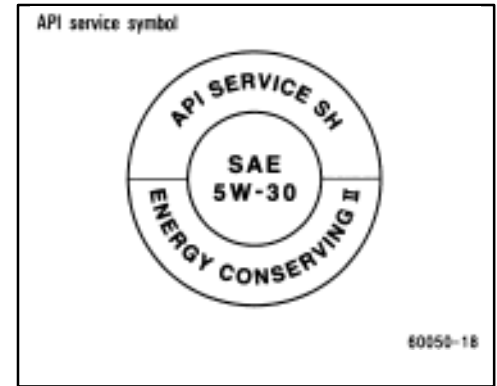

Oil identification marks

Either or both API registered marks are added to some oil containers to help you select the oil you should use.

The API Service Symbol is located anywhere on the outside of the container.

The top portion of the label shows the oil quality by API (American Petroleum Institute) designations such as SH. The center portion of the label shows the SAE viscosity grade such as SAE 5W-30. “Energy-Conserving II” shown in the lower portion, indicates that the oil has fuel-saving capabilities. Oils marked “Energy-Conserving II” will have higher fuel-saving capabilities than oil marked “Energy-Conserving”.



The ILSAC (International Lubricant Standardization and Approval Committee) Certification Mark is displayed on the front of the container.

Checking the engine coolant level

Look at the see-through coolant reservoir when the engine is cold. The coolant level is satisfactory if it is between the "FULL" and "LOW" lines on the reservoir. If the level is low, add ethylene-glycol type coolant.

The coolant level in the reservoir will vary with engine temperature. However, if the level is on or below the "LOW" line, add coolant. Bring the level up to the "FULL" line.

Use only ethylene-glycol type coolant. See information in the next column.

If the coolant level drops within a short time after replenishing, there may be a leak in the system. Visually check the radiator, hoses, radiator cap and drain cock and water pump.

If you can find no leak, have your Toyota dealer test the cap pressure and check for leaks in the cooling system.



To prevent burning yourself, do not remove the radiator cap when the engine is hot.

Coolant type selection

Your coolant must contain ethylene-glycol antifreeze. In addition to preventing freezing and subsequent damage to the engine, this will also prevent corrosion. Further supplemental inhibitors or additives are neither needed nor recommended.

Read the antifreeze container for information on freeze protection. Follow the manufacturer's directions for how much to mix with water. The total capacity of the cooling system is given in Part 8. We recommend 50% solution be used for your Toyota, or a sufficient quantity to provide protection to about -35°C (-31°C).

NOTICE

Do not use alcohol type antifreeze or plain water alone.

Checking brake fluid

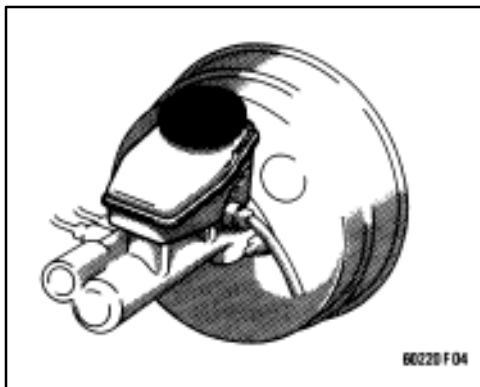

To check the fluid level, simply look at the see through reservoir. The level should be between the “MAX” and “MIN” lines on the reservoir.

It is normal for the brake fluid level to go down slightly as the brake pads wear. So be sure to keep the reservoir filled.

If the reservoir needs frequent refilling, it may indicate a serious mechanical problem.

If the level is low, add SAE J1703 or FMVSS No. 116 DOT 3 brake fluid to the brake reservoir.

Remove and replace the reservoir cover by hand. Fill the brake fluid to the dotted-line. This brings the fluid to the correct level when you put the cover back on.

Use only newly opened brake fluid. Once opened, brake fluid absorbs moisture from the air, and excess moisture can cause a dangerous loss of braking.



Take care when filling the reservoir because brake fluid can harm your eyes and damage painted surfaces. If fluid gets in your eyes, flush your eyes with clean water.

NOTICE

If you spill the fluid, be sure to wash it off with water to prevent it from damaging the parts or paint.

Checking power steering fluid

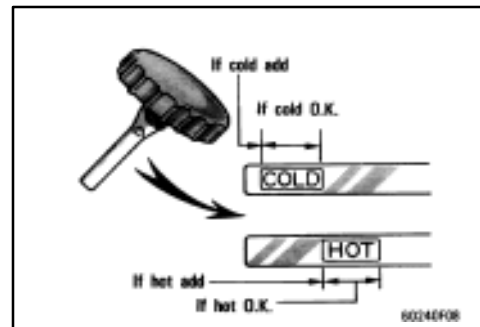

Check the fluid level on the dipstick. If necessary, add automatic transmission fluid DEXRON® II or III.

If the vehicle has been driven around 80 km/h (50 mph) for 20 minutes (a little more in frigid temperatures), the fluid is hot (60°C—80°C or 140°F—175°F). You may also check the level when the fluid is cold (about room temperature, 10°C—30°C or 50°F—85°F) if the engine has not been run for about five hours.

- Clean all dirt from outside of the reservoir tank.
- Remove the filler cap by turning it counterclockwise and wipe the dipstick clean.

- c. Reinstall the filter cap.
- d. Remove the filter cap again and look at the fluid level. If the fluid is cold, the level should be in the "COLD" range on the dipstick. Similarly, if it is hot, the fluid level should be in the "HOT" range. If the level is at the low side of either range, add automatic transmission fluid DEXRON®II or III to bring the level within the range.
- e. After replacing the filter cap, visually check the steering box case., vane pump and hose connections for leaks or damage.



CAUTION

The reservoir tank may be hot so be careful not to burn yourself.

NOTICE

Avoid overfilling, or the power steering could be damaged.

Checking tire pressure

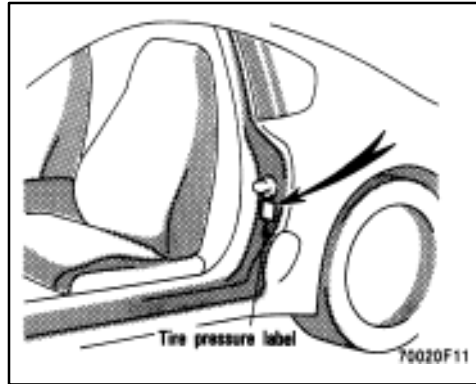

Keep your tire pressures at the proper level.

The recommended cold tire pressures, tire size and the vehicle capacity weight are also given in Part 8. They are also on the tire pressure as label shown.

You should check the tire pressures every two weeks, or at least once a month. And don't forget the spare!

Incorrect tire pressure can reduce tire life and make your vehicle less safe to drive.

Low tire pressure results in excessive wear, poor handling, reduced fuel economy, and the possibility of blowouts from overheated tires. Also, low tire pressure can cause poor sealing of the tire bead. If the tire pressure is excessively low, there is the possibility of wheel deformation and/or tire separation.

High tire pressure produces a harsh ride, handling problems, excessive wear at the center of the tire tread, and a greater possibility of tire damage from road hazards. If a tire frequently needs refilling, have it checked by your Toyota dealer.

The following instructions for checking tire pressure should be observed:

◀ **The pressure should be checked only when the tires are cold.** If your vehicle has been parked for at least 3 hours and has not been driven for more than 1.5 km or 1 mile since, you will get an accurate cold tire pressure reading.

◀ **Always use a tire pressure gauge.** The appearance of a tire can be misleading. Besides, the pressures that are even just a few pounds off can degrade handling and ride.

- ◀ **Take special care when adding air to the compact spare tire.** The smaller tire size can gain pressure very quickly. Add compressed air in small quantities and check the pressure often until it reaches the specified pressure.
- ◀ **Do not bleed or reduce tire pressure after driving.** It is normal for the tire pressure to be higher after driving
- ◀ **Never exceed the vehicle capacity weight.** The passenger and luggage weight should be located so that the vehicle is balanced.
- ◀ **Be sure to reinstall the tire inflation valve caps.** Without the valve caps, dirt or moisture could get into the valve core and cause air leakage. If the caps have been lost, have new ones put on as soon as possible.

Checking and replacing tires

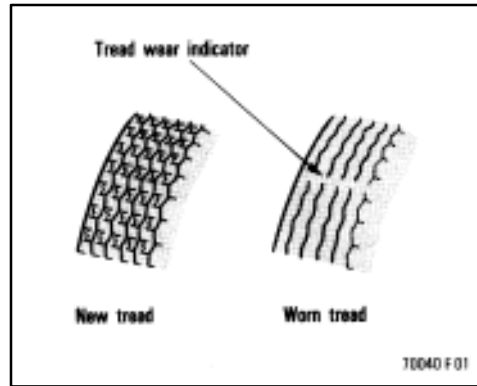

CHECKING YOUR TIRES

Check the tire tread for the tread wear indicators. If the indicators show, replace the tires.

The tires on your Toyota have built-in tread wear indicators to help you know when the tires need replacement. When the tread depth wears to 1.6 mm (0.06 in.) or less, the indicators will appear. If you can see the indicators in two or more adjacent grooves, the tire should be replaced. The lower the tread, the higher the risk of skidding.

Your Supra has been fitted with specially developed tires which provide exceptional dynamic performance under general road conditions. However, you may also notice that your tires wear more rapidly than standard tires as a result of their superior performance.

The effectiveness of snow tires is lost if the tread wears down below 4 mm (0.16 in.).

Check the tires regularly for damage such as cuts, splits and cracks. If any damage is found, consult with a technician and have the tire repaired or replaced.

Even if the damage does not appear serious, a qualified technician should examine the damage. Objects which have penetrated the tire may have caused internal damage.

Any tires which are over six years old must be checked by a qualified technician even if damage is not obvious.

Tires deteriorate with age even if they have never or seldom been used.

This also applies to the spare tire and tires stored for future use.

REPLACING YOUR TIRES

When replacing a tire, use only the same size and construction as originally installed and with the same or greater load capacity.

Using any other size or type of tire may seriously affect handling, ride, speedometer/odometer calibration, ground clearance, and clearance between the body and tires or snow chains



◀ Do not mix radial, bias belted, or bias-ply tires on your vehicle. It can cause dangerous handling characteristics, resulting in loss of control.

◀ Do not use tire or wheels other than the manufacturer's recommended size.

Toyota recommends all four tires, or at least both of the front or rear tires be replaced at a time as a set.

See "If you have a flat tire" in Part 4 for tire change procedure.

When a tire is replaced, the wheel should always be balanced.

An unbalanced wheel may affect vehicle handling and tire life. Wheels can get out of balance with regular use and should therefore be balanced occasionally.

When replacing a tubeless tire, the air valve should also be replaced with a new one.

Rotating tires

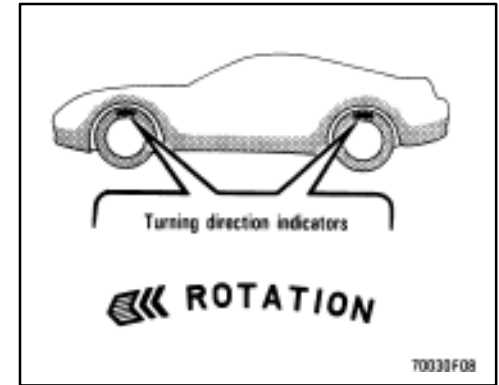

Do not perform rotation of the tires, from front to rear or from left to right, or using the compact spare tire. Performing such tire rotation may result in the tires interfering with the body or in uneven wear of the tires, so that steerability of the vehicle is impaired.

Tires with turning direction indicator—
The tire is a uni-directional type and cannot be used for tire rotation. Using the tire on the opposite side to the designated side will impair the tire performance.

The compact spare tire—

The tire is designed for temporary use only and cannot be used for tire rotation.

Installing snow tires and chains

WHEN TO USE SNOW TIRES OR CHAINS

Snow tires or chains are recommended when driving on snow or ice. On wet or dry roads, conventional tires provide better traction than snow tires.

SNOW TIRE SELECTION

If you need snow tires, select tires of the same size, construction and load capacity as the original tires on your Toyota.

Do not install studded tires without first checking local regulations for possible restrictions.

SNOW TIRE INSTALLATION

Snow tires should be installed on all wheels.

Installing snow tires on the front wheels only can lead to an excessive difference in road grip capability between the front and rear tires which would cause loss of vehicle control.

When storing removed tires, you should store them in a cool dry place. Mark the direction of rotation and be sure to install Mark the direction of rotation and be sure to install them in the same direction when replacing.



- ◀ Do not drive with the snow tires incorrectly inflated.
- ◀ Never drive over 120 km/h (75 mph) with any type of snow tires.

TIRE CHAIN SELECTION

Use the tire chains of correct size and type.

Use SAE Class “S” type radial tire chains except radial cable chains or V-bar type chains.

Regulations regarding the use of tire chains vary according to location or type of road, so always check them before installing chains.

NOTICE

Do not install tire chains on the 255/40zr17 tires, as this could damage the vehicle body.

CHAIN INSTALLATION

Install the chains on the rear tires as tightly as possible. Do not use tire chains on the rear tires. Retighten chains after driving 0.5—1.0 km (1/4—1/2 mile).

When installing chains on your tires, carefully follow the instructions of the chain manufacturer.

If wheel covers are used, they will be scratched by the chain band, so remove the covers before putting on the chains.



- ◀ Do not exceed 50 km/h (30 mph) or the chain manufacturer’s recommended speed limit, whichever is lower.
- ◀ Drive carefully avoiding bumps, holes, and sharp turns, which may cause the vehicle to bounce.
- ◀ Avoid sharp turns or locked-wheel braking, as use of chains may adversely affect vehicle handling.

NOTICE

Do not attempt to use a tire chain on the compact spare tire, as it may result in damage to the vehicle as well as the tire.

Replacing wheels

WHEN TO REPLACE YOUR WHEELS

If you have wheel damage such as bending, cracks or heavy corrosion, the wheel should be replaced.

If you fail to replace damaged wheels, the tire may slip off the wheel or they may cause loss of handling control.

WHEEL SELECTION

When replacing wheels, care should be taken to ensure that the wheels are replaced by ones with the same load capacity, diameter, rim width, and offset.

This must be observed on compact spare tires, too.

Correctly replacement wheels are available at your Toyota dealer..

A wheel of a different size or type may adversely affect handling, wheel and bearing life, brake cooling, speedometer/odometer calibration, stopping ability, headlight aim, bumper height, vehicle ground clearance, and tire or snow chain clearance to the body and chassis.

Replacement with used wheels is not recommended as they may have been subjected to rough treatment or high mileage and could fail without warning. Also, bent wheels which have been straightened may have structural damage and therefore should not be used. Never use an inner tube in a leaking wheel which is designed for a tubeless tire.

Aluminum wheel precautions

- ◀ After driving your vehicle the first 1600 km (1000 miles), check that the wheel nuts are tight.
- ◀ If you have repaired or changed your tires, check that the wheel nuts are still tight after driving 1600 km (1000 miles).
- ◀ When using tire chians, be careful not to damage the aluminum wheels.
- ◀ Use only the Toyota wheel nuts and wrench designed for your aluminum wheels
- ◀ When balancing your wheels, use only Toyota balance weights or equivalent and a plastic or rubber hammer.
- ◀ As with any wheel, periodically check your aluminum wheels for damage. If damage, replace immediatly.

Part 7

DO-IT-YOURSELF MAINTENANCE—

Chapter 7-3

Electrical components

- Ⓡ Checking battery condition
- Ⓡ Battery recharging precautions
- Ⓡ Checking and replacing fuses
- Ⓡ Adding washer fluid
- Ⓡ Checking the headlight aim
- Ⓡ Replacing light bulbs

Checking battery condition— —Precautions



BATTERY PRECAUTIONS

The battery produces flammable and explosive hydrogen gas.

- Ⓡ Do not cause a spark from the battery with tools.
- Ⓡ Do not smoke or light a match near the battery.

The electrolyte contains poisonous and corrosive sulfuric acid.

- Ⓡ Avoid contact with eyes, skin or clothes.
- Ⓡ Never ingest electrolyte.
- Ⓡ Wear protective safety glasses when working near the battery.
- Ⓡ Keep children away from the battery.

EMERGENCY MEASURES

- Ⓡ If electrolyte gets in your eyes, flush your eyes with clean water for at least 15 minutes and get immediate medical attention. If possible, continue to apply water with a sponge or cloth while en route to the medical office.

- Ⓡ If electrolyte gets on your skin, thoroughly wash the contact area. If you feel pain or burning, get medical attention immediately.
- Ⓡ If electrolyte gets on your clothes, there is a possibility of its soaking through to your skin, so immediately take off the exposed clothing and follow the procedure above, if necessary.
- Ⓡ If you happen to swallow electrolyte, drink a large quantity of water or milk. Follow with milk of magnesia, beaten raw egg or vegetable oil. Then go immediately for emergency help.

—Checking battery exterior

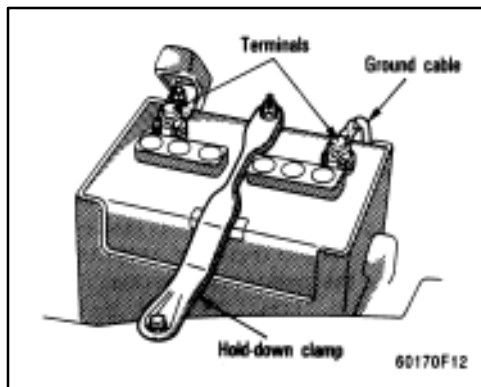

Check the battery for corroded or loose terminal connections, cracks, or loose hold-down clamp.

- a. If the battery is corroded, wash it off with a solution of warm water and baking soda. Coat the outside of the terminals with grease to prevent further corrosion.
- b. If the terminal connections are loose, tighten their clamp nuts—but do not over-tighten.
- c. Tighten the hold-down clamp only enough to keep the battery firmly in place. Overtightening may damage the battery case.

NOTICE

- ◀ ***Be sure the engine and all accessories are off before performing maintenance.***
- ◀ ***When checking the battery, remove the ground cable from the negative terminal (“-” mark) first and reinstall it last.***
- ◀ ***Be careful not to cause a short circuit with tools.***
- ◀ ***Take care no solution gets into the battery when washing it.***

—Checking battery fluid

There are two types of batteries: Maintenance type and non-maintenance type.

A non-maintenance battery has “MAINTENANCE FREE BATTERY” on its top. A maintenance type battery does not have such indication.

Maintenance type battery—

Check the fluid condition by the fluid level lines on the side of the battery. Or if the battery has a hydrometer on its top, you can also check the hydrometer.

Non-maintenance battery—

Check the battery condition by the hydrometer on the top of the battery.

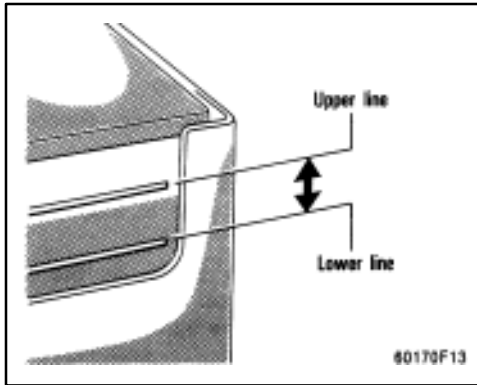

CHECKING BY THE FLUID LEVEL LINES (MAINTENANCE TYPE BATTERY ONLY)

The fluid (electrolyte) level must be between the upper and lower lines.

When checking the fluid level, look at all six cells, not just one or two.

If the level is lower than the lower line, add distilled water. (See "ADDING DISTILLED WATER".)

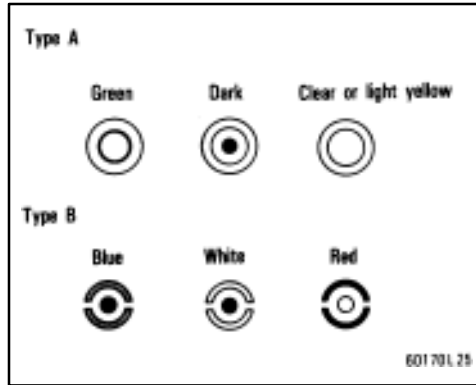

CHECKING BY THE HYDROMETER

Check the battery condition by the hydrometer color.

Hydrometer color		Condition
Type A	Type B	
GREEN	BLUE	Good
DARK	WHITE	Charging necessary. Have battery checked by your Toyota dealer.
CLEAR or LIGHT YELLOW	RED	Add distilled water*

*: See "ADDING DISTILLED WATER".

Non-maintenance battery

Hydrometer color		Condition
Type A	Type B	
GREEN	BLUE	Good
DARK	WHITE	Charging necessary. Have battery checked by your Toyota dealer.
CLEAR or LIGHT YELLOW	RED	Have battery checked by your Toyota dealer.

NOTICE
Do not refill the battery with water.

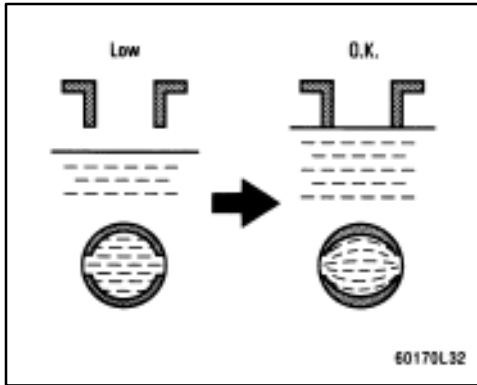

ADDING DISTILLED WATER (MAINTENANCE TYPE BATTERY ONLY)

1. Remove the vent plugs.
2. Add distilled water to cells needing fluid.

If the side of your battery is covered, check the water level by looking down directly above the cell as illustrated above.

3. Retighten the vent plugs securely

NOTICE

Do not overfill the cells. Excess electrolyte could squirt out of the battery during heavy charging, causing corrosion or damage.

Battery recharging precautions

During recharging, the battery is producing hydrogen gas.

Therefore, before recharging:

1. Maintenance type batteries—Remove the vent plugs.
2. If recharging with the battery installed on the vehicle, be sure to disconnect the ground cable.
3. Be sure the power switch on the recharger is off when connecting the charger cables to the battery and when disconnecting them.



®Always charge the battery in an unconfined area. Do not charge the battery in a garage or closed room where there is not sufficient ventilation.

®Non-maintenance batteries: Only do a slow charge (5A or less). Charging at a quicker rate is dangerous. The battery may explode, causing personal injuries.

Maintenance type batteries: Be sure to remove the vent plugs before recharging.

Checking and replacing fuses

NOTICE

Never recharge the battery while the engine is running. Also, be sure all accessories are turned off.

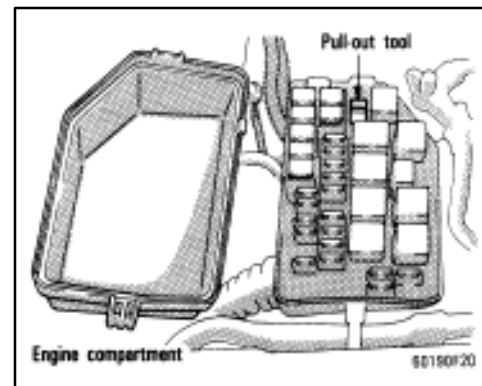
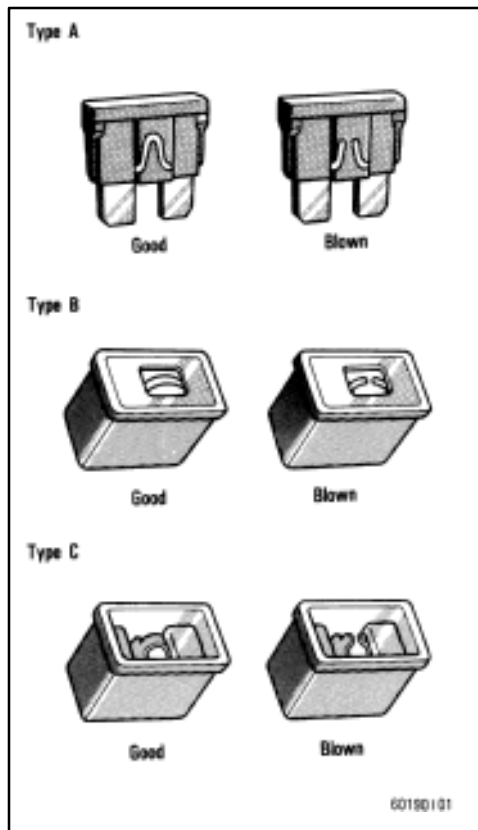

If the headlights or other electrical components do not work, check the fuses. If any of the fuses are blown, they must be replaced.

See "Fuse locations" in Chapter 7-1 for locations of the fuses.

Turn the ignition switch and inoperative component off. Pull a suspected fuse straight out and check it.

Determine which fuse may be causing the problem. The lid of the fuse box shows the name of the circuit for each fuse. See Part 8 of this manual for the functions controlled by each circuit.

Type A fuses can be pulled out by using the pull-out tool.

If you are not sure whether the fuse has blown, try replacing the suspected fuse with one that you know is good.

If the fuse has blown, push a new fuse into the clip.

Only install a fuse with the amperage rating designated on the fuse box lid.

If you do not have a spare fuse, in an emergency you can pull out the “CIG”, “RAD NO. 2”, “DOME” or “HTR” fuse, which may be dispensable for normal driving, and use it if its amperage rating is the same.

If you cannot use one of the same amperage, use one that is lower, but as close as possible to the rating. If the amperage is lower than that specified, the fuse might blow out again but this does not indicate anything wrong. Be sure to get the correct fuse as soon as possible and return the substitute to its original clip.

It is a good idea to purchase a set of spare fuses and keep them in your vehicle for emergencies.

If the new fuse immediately blows out, there is a problem with the electrical system. Have your Toyota dealer correct it as soon as possible.



Never use a fuse with a higher amperage rating, or any other object, in place of a fuse. This may cause extensive damage and possibly a fire.

Adding washer fluid

If any washer does not work, the washer tank may be empty. Add washer fluid.

You may use plain water as washer fluid. However, in cold areas where temperatures range below freezing point, use washer fluid containing antifreeze. This product is available at your Toyota dealer and most auto parts stores. Follow the manufacturer's directions for how much to mix with water.

NOTICE

Do not use engine antifreeze or any other substitute because it may damage your vehicle's paint.

Checking the headlight aim

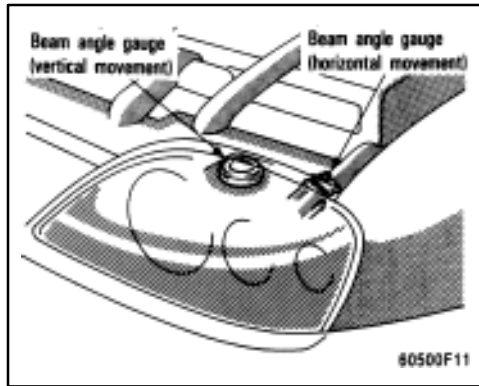

Before checking the headlight aim:

1. Be sure that the body around the headlight is not deformed.
2. Park the vehicle on a level spot.
3. The driver gets into the driver's seat and puts the vehicle in a state readying for a driving (with a full tank).
4. Bounce the vehicle several times

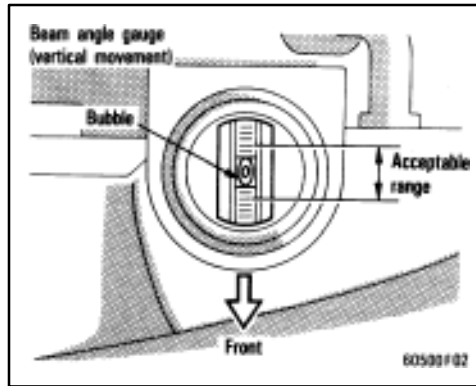

To check the headlight aim, check the vertical and horizontal gauges.

1. Look at the beam angle gauge (vertical movement). The bubble of the gauge should not deviate from the center of the gauge by more than two marks on either side of the gauge.

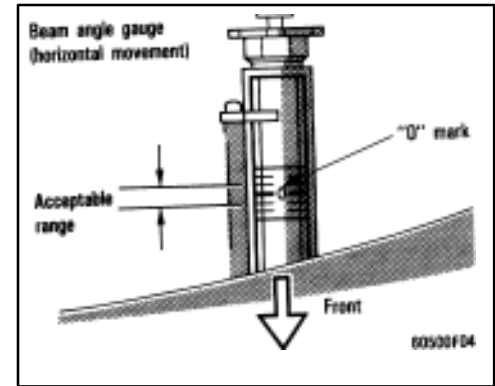

2. Look at the beam angle gauge (horizontal movement). The "0" mark should not deviate by more than one mark on either side of the gauge.

If the error is over the value specified above, take the vehicle to your Toyota dealer to adjust the headlight aim.

Replacing light bulbs—

The following illustrations show how to gain access to the bulbs. When replacing a bulb, make sure the ignition switch and light switch are off. Use bulbs with the wattage ratings given in the table.



CAUTION

Halogen bulbs have pressurized gas inside and require special handling. They can burst or shatter if scratched or dropped. Hold a bulb only by its plastic or metal case. Do not touch the glass part of a bulb with bare hands.

NOTICE

Only use a bulb of the listed type.

Light bulbs	Bulb No.	W	Type
Headlight (low beam)	9006	55	A
Headlight (high beam)	9005	65	B
Front fog lights	—	55	C
Parking lights	—	5	E
Front turn signal lights	7440	21	E
Front side marker lights	194	3.8	E
Rear side marker lights	194	3.8	E
Rear turn signal lights	7440	21	E
Stop and tail lights	7443	21/5	E
Back-up lights	7440	21	E
License plate light	—	5	E
Interior lights	—	8	D
Glovebox light	—	1.2	E
Luggage compartment light	—	5	F

A: HB4 halogen bulbs
 B: HB3 halogen bulbs
 C: H3 halogen bulbs
 D: Single end bulbs
 E: Wedge base bulbs
 F: Double end bulbs

—Headlights (low beam)

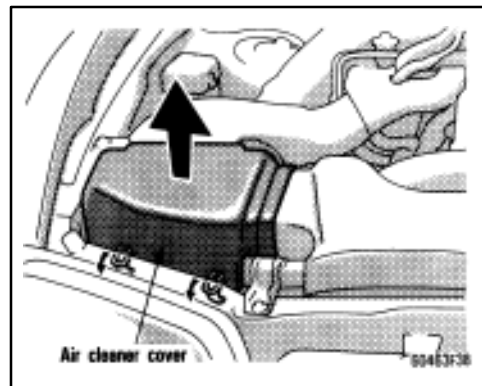

1. Open the hood.

RIGHT SIDE HEADLIGHT: Release the clips of the air cleaner and remove the air cleaner cover.

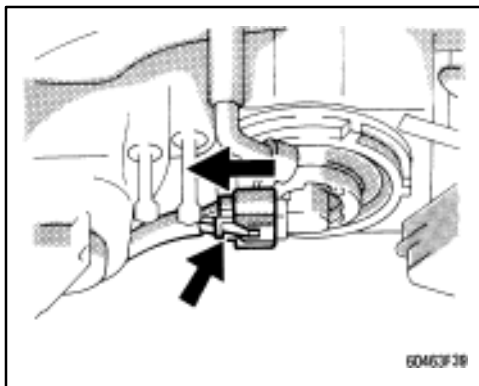

2. Unplug the connector while depressing the lock release.

If the connector is tight, wiggle it.

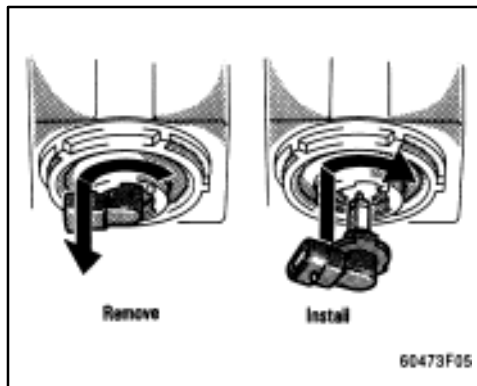

3. Turn the bulb clockwise and remove it. Install a new bulb, turn it counterclockwise, then plug in the connector.

To install a bulb, align the tab of the bulb socket with the cutouts of the mounting hole.

RIGHT SIDE HEADLIGHT: Install the air cleaner cover securely.

Aiming is not necessary after replacing the bulb. When aiming adjustment is necessary, contact your Toyota dealer.

—Headlights (high beam)

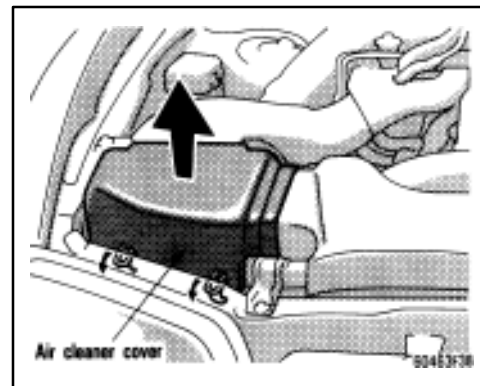

1. Open the hood.

RIGHT SIDE HEADLIGHT: Release the clips of the air cleaner and remove the air cleaner cover.

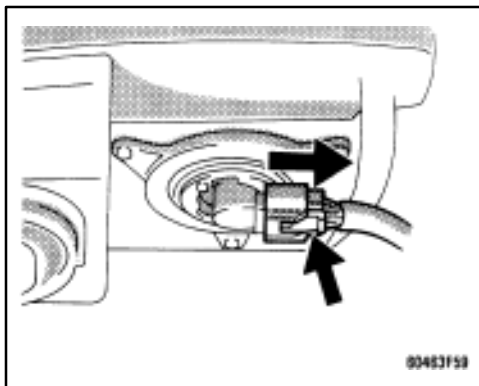

2. Unplug the connector while depressing the lock release.

If the connector is tight, wiggle it.

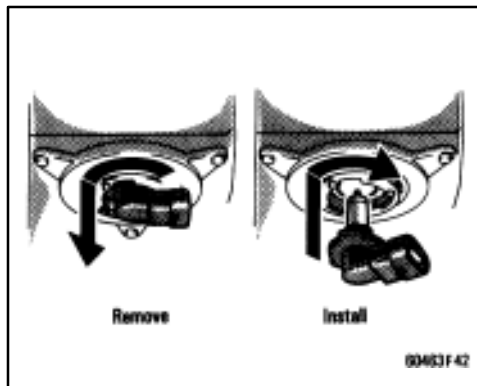

3. Turn the bulb counterclockwise and remove it. Install a new bulb, turn it clockwise, then plug in the connector.

To install a bulb, align the tab of the bulb socket with the cutouts of the mounting hole.

RIGHT SIDE HEADLIGHT: Install the air cleaner cover securely.

Aiming is not necessary after replacing the bulb. When aiming adjustment is necessary, contact your Toyota dealer.

—Front fog lights

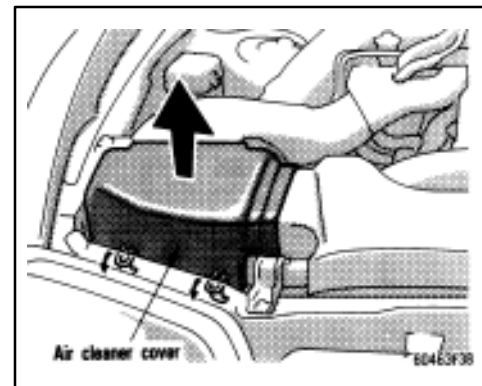

1. Open the hood.

RIGHT SIDE HEADLIGHT: Release the clips of the air cleaner and remove the air cleaner cover.

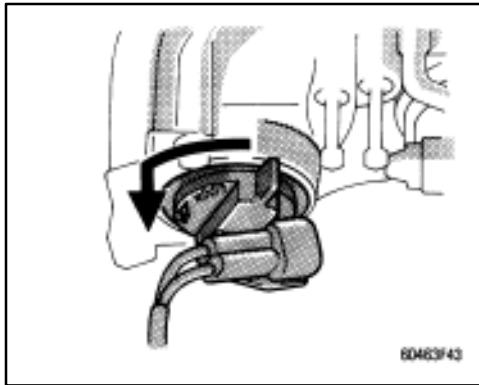

2. Turn the cover counterclockwise and remove it.

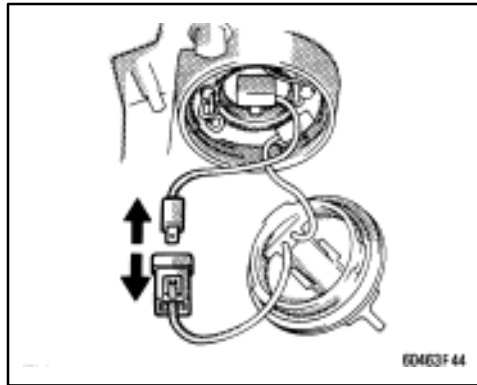

3. Disconnect the cords.

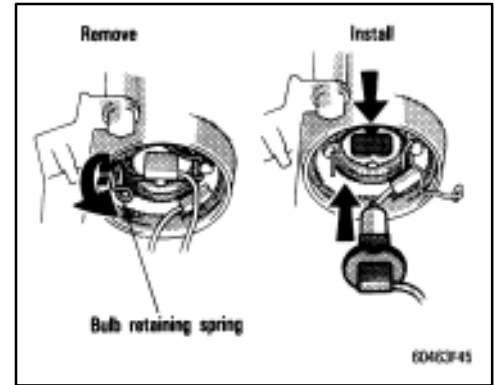

4. Release the bulb retaining spring and remove the bulb. Install a new bulb and the bulb retaining spring.

To install the bulb, align the cutouts of the bulb with the protrusions of the mounting hole.

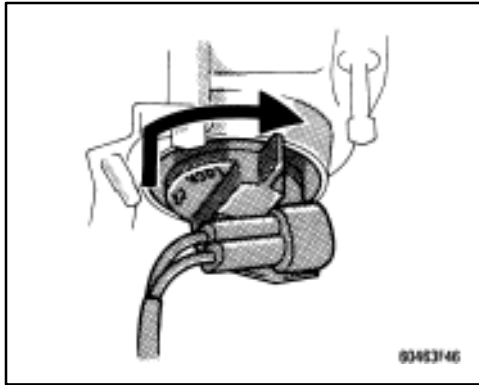

5. Connect the cords and install the cover by turning it clockwise.

RIGHT SIDE HEADLIGHT: Install the air cleaner cover securely.

—Parking lights

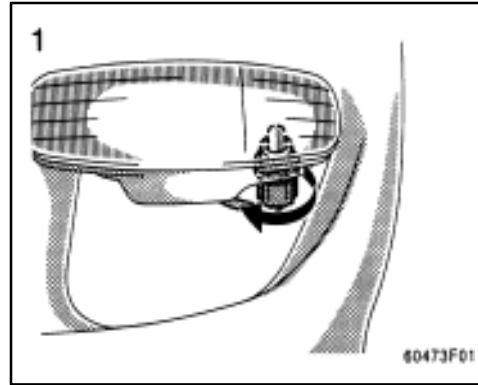

—Front turn signal lights

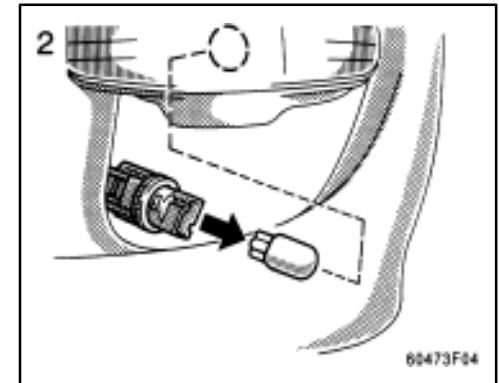
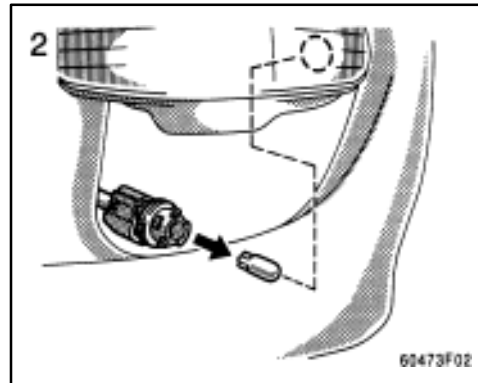
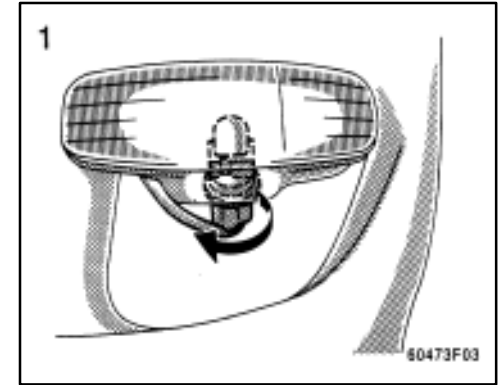

—Front side marker lights

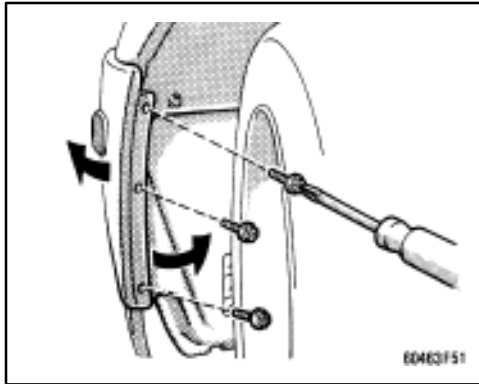

Use a Phillips-head screw driver

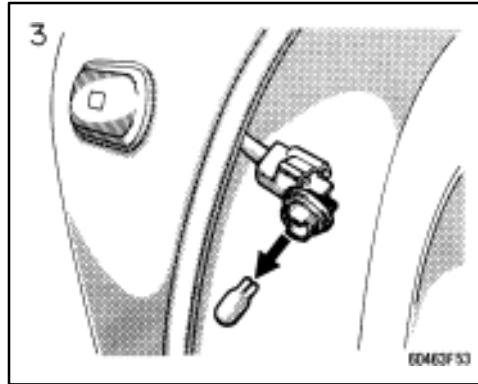
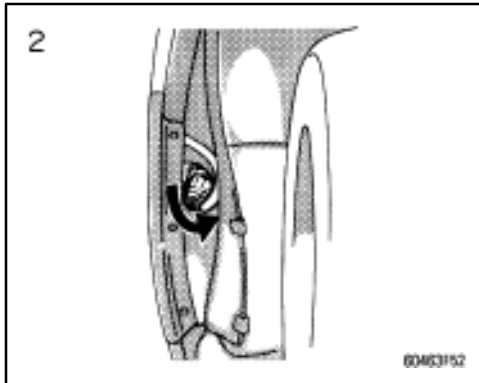

—Rear side marker lights

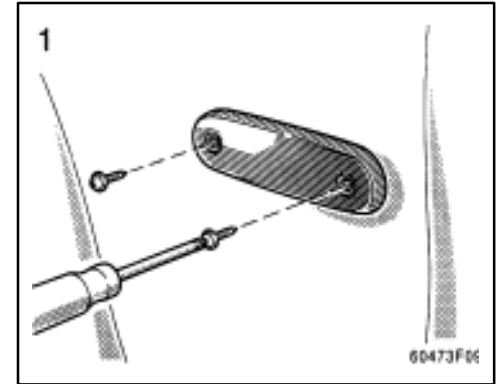

Use a Phillips-head screwdriver.

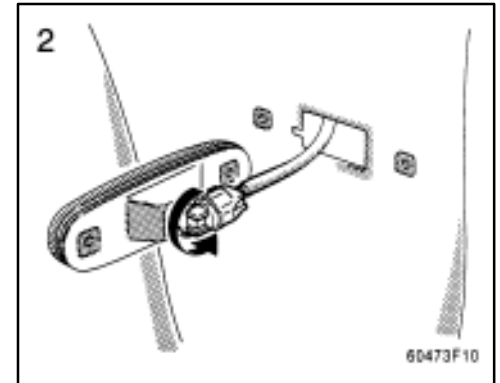

—Rear turn signal, stop and tail, and back-up lights

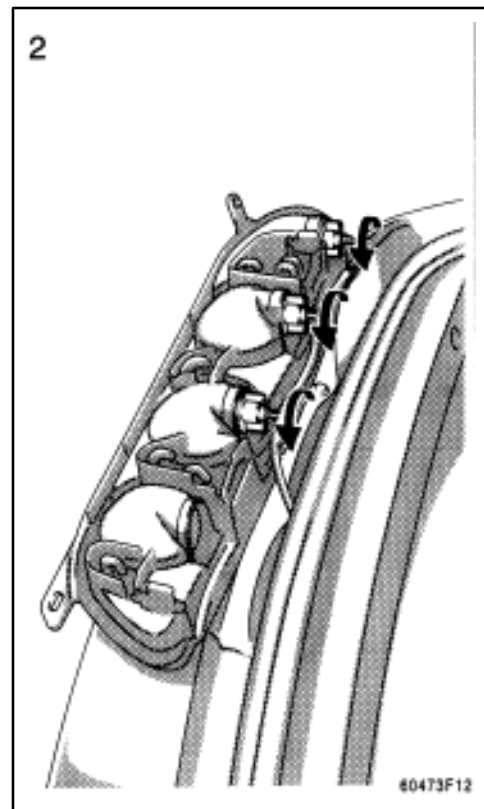
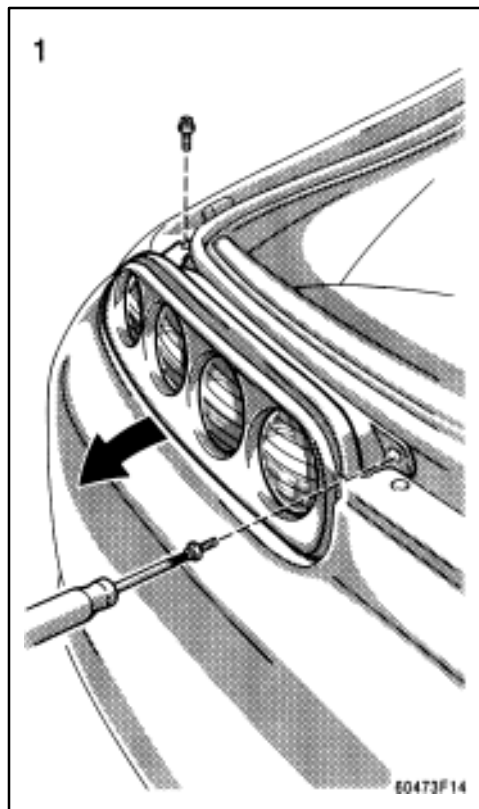
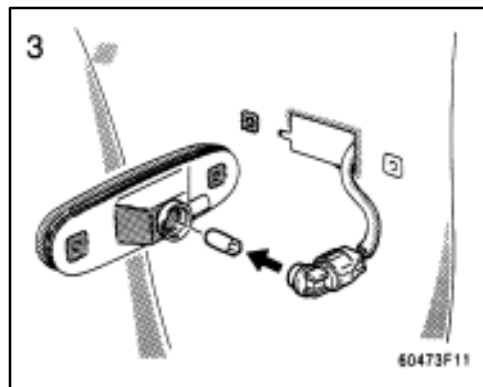

Use a Phillips-head screwdriver.

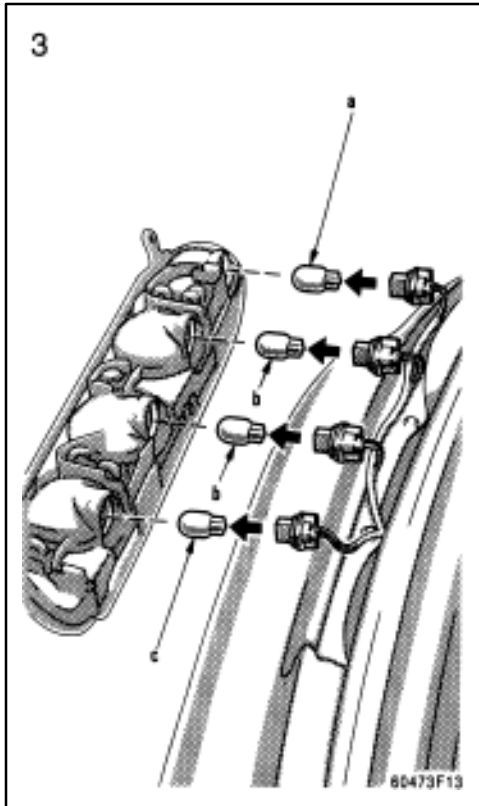

—License plate lights

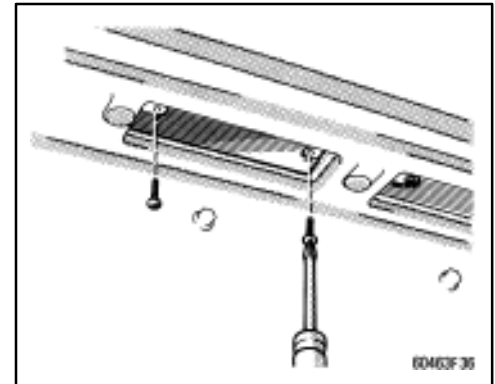

Use a Phillips-head screwdriver.

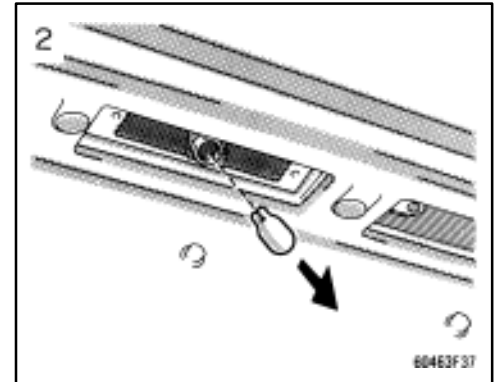

Part 8

SPECIFICATIONS

- ® [Dimensions and weight](#)
- ® [Engine](#)
- ® [Fuel](#)
- ® [Service specifications](#)
- ® [Tires](#)
- ® [Fuses](#)

Dimensions and weight

Overall length	mm (in.)	4515 (177.7)
Overall width	mm (in.)	1810 (71.3)
Overall height	mm (in.)	1275 (50.2)*
Wheelbase	mm (in.)	2550 (100.4)
Front tread	mm (in.)	1520 (59.9)
Rear tread	mm (in.)	1525 (60.1)
Vehicle capacity weight (occupants + luggage)	kg (lb.)	330 (725)

*: Unladen vehicle

Engine

Model:

2JZ-GE and 2JZ-GTE

Type:

2JZ-GE engine

6 cylinder in line, 4 cycle, gasoline

2JZ-GTE engine

6 cylinder in line, 4 cycle, gasoline

(with turbocharger)

Bore and stroke, mm (in.):

86.0 x 86.0 (3.39 x 3.39)

Displacement, cm³ (cu. in.):

2997 (182.9)

Fuel

Fuel type:

Premium unleaded gasoline, Research Octane Number 96 (Octane Rating 91) or higher

Fuel tank capacity, L (gal., Imp. gal.):

70 (18.5, 15.4)

Service specifications

ENGINE

Valve clearance (engine cold), mm (in.):

Intake 0.15—0.25 (0.006—0.010)

Exhaust 0.25—0.35 (0.010—0.014)

Spark plug type:

2JZ-GE engine

NIPPONDENSO

PK16R11

NGK

BKR5EP11

2JZ-GTE engine

NIPPONDENSO

PK20R11

NGK

BKR6EP11

Spark plug gap, mm (in.):

1.1 (0.043)

ENGINE LUBRICATION

Oil capacity (drain and refill),

L (qt., Imp. qt.):

2JZ-GE engine

With filter 5.2 (5.5, 4.6)

Without filter 4.9 (5.2, 4.3)

2JZ-GTE engine

With filter 5.0 (5.3, 4.4)

Without filter 4.7 (5.0, 4.1)

Oil grade:

API SH, "Energy-Conserving II" multi-grade engine oil or ILSAC multigrade engine oil

Recommended oil viscosity (SAE):

2JZ-GE engine

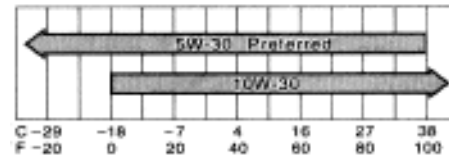

Temperature range anticipated before next oil change.

L70010

2JZ-GTE engine

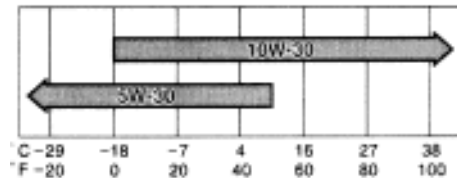

Temperature range anticipated before next oil change.

L70009

COOLING SYSTEM

Total capacity, L (qt., Imp. qt.):

2JZ-GE engine

With manual transmission

7.3 (7.7, 6.4)

With automatic transmission

8.3 (8.8, 7.3)

2JZ-GTE engine

With manual transmission

8.9 (9.4, 7.8)

With automatic transmission

8.8 (9.3, 7.7)

Coolant type:

With ethylene-glycol antifreeze

(Do not use alcohol type.)

BATTERY

Open voltage* at 20 ◀ (68 ◀):

12.7 V Fully charged

12.3 V Half charged

11.9 V Discharged

*: Voltage that is checked 20 minutes after the key is removed with all the lights turned off

Charging rates:

5 A max.

CLUTCH

Pedal freeplay, mm (in.):

5—15 (0.2—0.6)

Fluid type:

SAE J1703 or FMVSS No. 116

DOT 3

MANUAL TRANSMISSION

Oil capacity, L (qt., Imp. qt.):

5-speed 2.6 (2.7, 2.3)

6-speed 1.8 (1.9, 1.6)

Oil type:

5-speed

Multipurpose gear oil API GL-4
or GL-5

6-speed

ESSO ATF DEXRON® D-21065,
TOYOTA GEAR OIL V160 or
equivalent

Recommended oil viscosity:

SAE 75W-90

AUTOMATIC TRANSMISSION

Fluid capacity (drain and refill),

L (qt., Imp. qt.):

2JZ-GE engine Up to 1.6 (1.7, 1.4)

2JZ-GTE engine Up to 1.9 (2.0, 1.7)

Fluid type:

2JZ-GE engine

Automatic transmission fluid D-II
or DEXRON® III (DEXRON® II)

2JZ-GTE engine

Automatic transmission fluid
TYPE T-II or equivalent

DIFFERENTIAL

Oil capacity, L (qt., Imp. qt.):

1.35 (1.43 1.19)

Oil type:

Hypoid gear oil API GL-5

Recommended oil viscosity:

Above -18°C (0°F)

SAE 90

Below -18°C (0°F)

SAE 80W or 80W-90

BRAKES

Minimum pedal clearance when depressed with the pressure of 490 N (50 kgf, 110 lbf) with the engine running, mm (in.):

2JZ-GE engine 72 (2.8)

2JZ-GTE engine 70 (2.8)

Pedal freeplay, mm (in.):

1—6 (0.04—0.24)

Pad wear limit, mm (in.):

1.0 (0.04)

Lining wear limit, mm (in.):

1.0 (0.04)

Parking brake adjustment when pulled with the force of 196 N (20 kgf, 44 lbf):

5—8 clicks

Fluid type:

SAE J1703 or FMVSS No. 116
DOT 3

STEERING

Wheel freeplay:

Less than 30 mm (1.2 in.)

Power steering fluid type:

Automatic transmission fluid
DEXRON®II or III

Tires

Tire size:

Spare tire

T145/70 R 17

Except spare tire

2JZ—GE engine

225/50R 16 92V (for front use only)

245/45R 16 94V (for rear use only)

2JZ—GTE engine

235/45ZR 17 (for front use only)

255/40ZR 17 (for rear use only)

Tire pressure, kPa (kgf/cm² or bar, psi):

Spare tire 420 (4.2, 60)

Except spare tire 230 (2.3, 33)

Wheel size:

225/50R 16 92V 16 x 8JJ

245/45R 16 94V 16 x 9JJ

235/45ZR 17 17 x 8JJ

255/40ZR 17 17 x 9.5JJ

T145/70R 17 17 x 4T

Wheel nut torque, N·m (kgf·m, ft·lbf):

103 (10.5, 76)

Fuses

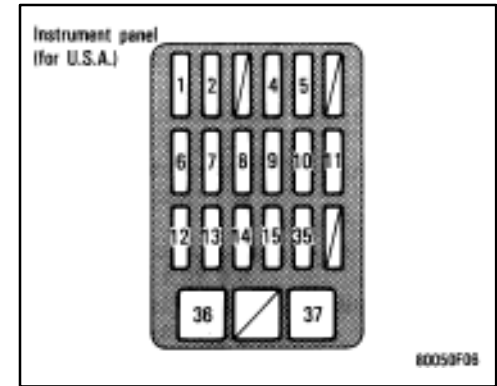

Fuses (type A)

- 1. WIPER 20 A:** Windshield wipers and washer, rear window wiper and washer
- 2. HTR 7.5 A:** Air conditioning system
- 3. SEAT—HTR 15 A:** Seat heater
- 4. ST 7.5 A:** Starter system
- 5. IGN 7.5 A:** Charging system, discharge warning light, multiport fuel injection system/sequential multiport fuel injection system, SRS airbag system
- 6. PANEL 10 A:** Instrument panel lights, instrument panel lights control
- 7. MIR—HTR 10 A:** Mirror heaters
- 8. TURN 7.5 A:** Turn signal lights

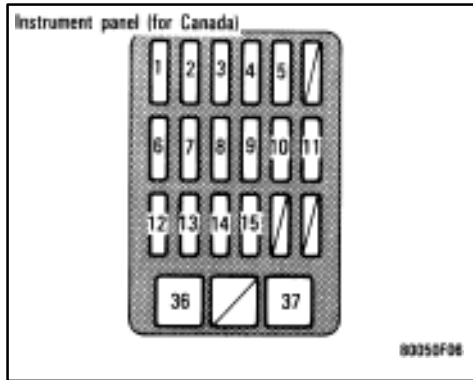

- 9. **STOP 15 A:** Stop lights, cruise control system cancel device
- 10. **CIG 15 A:** cigarette lighter, air conditioning system, SRS airbag system, theft deterrent system, shift lock control system
- 11. **RAD NO.2 7.5 A:** Radio, cassette tape player, power antenna
- 12. **TAIL 10 A:** Tail lights, parking lights, front side marker lights, rear side marker lights, licence plate lights
- 13. **ECU-IG 10A:** Cruise control system, anti-lock brake system, power steering, power antenna, theft deterrent system, shift lock control system, traction control system

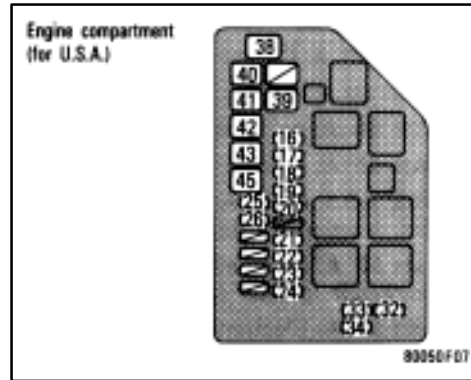

- 14. **GAUGE 10A:** Gauges and meters, service reminder indicators and warning buzzers (except discharge and open door warning lights), rear window defogger, charging system, cruise control system, electronically controlled automatic transmission system, traction control system
- 15. **ECU-B 10 A:** Air conditioning system, cruise control system, anti-lock brake system, SRS airbag system, traction control system
- 16. **EFI NO.2 30 A):** Multiport fuel injection system/sequential multiport fuel injection system

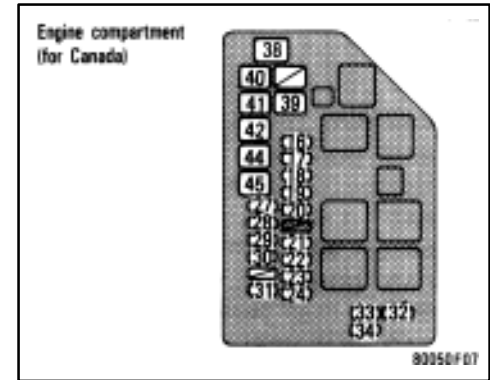

- 17. **EFI NO.1 30A:** Multiport fuel injection system/sequential multiport fuel injection system
- 18. **AM2 30 A:** Starter system
- 19. **FOG 15 A:** Front fog lights
- 20. **HAZ-HORN 15 A:** Emergency flashers, horns
- 21. **TRAC 7.5 A:** Traction control system
- 22. **ALT-S 7.5 A:** Charging system
- 23. **DOME 7.5 A:** Interior lights, personal lights, door courtesy lights, luggage compartment light, ignition switch light, open door warning light, theft deterrent system, daytime running light system

- 24.RAD NO.1 20 A:** Radio cassette tape player
- 25.HEAD (RH) 15 A:** Right-hand headlight
- 26.HEAD (LH) 15 A:** Left-hand headlight
- 27.HEAD (RH-LWR) 15 A:** Right-hand headlight (low beam)
- 28.HEAD (LH-LWR) 15 A:** Left-hand headlight (low beam)
- 29.HEAD (RH-UPR) 15 A:** Right-hand headlight (high beam)
- 30.HEAD (LH-UPR) 15 A:** Left-hand headlight (high beam)
- 31.DRL 7.5 A:** Daytime running light system
- 32.30 A:** Spare fuse
- 33.7.5 A:** Spare fuse
- 34.15 A:** Spare fuse
- 35.OBD-II 7.5 A:** On-board diagnosis system

Fuses (type B)

- 36.DOOR 30 A:** Power window, power door lock system, theft deterrent system
- 37.DEFOG 30 A:** Rear window defogger

Fuses (type C)

- 38.ALT 120 A:** Charging system
- 39.MAIN 50 A:** Starter system, headlights
- 40.HTR 50 A:** Air conditioning system
- 41.FAN 30 A:** Electric cooling fan
- 42.ABS NO.1 60 A:** Anti-lock brake system, traction control system
- 43.AM1 50 A:** Electronic ignition system/distributor ignition system
- 44.AM1 60 A:** Electronic ignition system/distributor ignition system
- 45.POWER 60 A:** "PANEL", "STOP", "TAIL", "ECU-B", "DEFOG" and "DOOR" fuses

Part 9

REPORTING SAFETY DEFECTS FOR U.S. OWNERS AND UNIFORM TIRE QUALITY GRADING

- ⑥ [Reporting safety defects for U.S. owners](#)
- ⑥ [Uniform tire quality grading](#)

Reporting safety defects for U.S. owners

If you believe that your vehicle has a defect which could cause a crash or could cause injury or death, you should immediately inform the National Highway Traffic Safety Administration (NHTSA) in addition to notifying Toyota Motor Sales, U.S.A., Inc. (Toll-free: 1-800-331-4331).

If NHTSA receives similar complaints, it may open an investigation, and if it finds that a safety defect exists in a group of vehicles, it may order a recall and remedy campaign. However, NHTSA cannot become involved in individual problems between you, your dealer, or Toyota Motor Sales, U.S.A., Inc.

To contact NHTSA, you may either call the Auto Safety Hotline tollfree at 1-800-424-9393 (or 366-0123 in Washington D.C. area) or write to: NHTSA, U.S. Department of Transportation, Washington D.C. 20590. You can also obtain other information about motor vehicle safety from the Hotline.

Uniform tire quality grading

This information has been prepared in accordance with regulations issued by the National Highway Traffic Safety Administration of the U.S. Department of Transportation. It provides the purchasers and/or prospective purchasers of Toyota vehicles with information on uniform tire quality grading.

Your Toyota dealer will help answer any questions you may have as you read this information.

DOT quality grades—All passenger vehicle tires must conform to Federal Safety Requirements in addition to these grades. These quality grades are molded on the sidewall.

Treadwear—The treadwear grade is a comparative rating based on the wear rate of the tire when tested under controlled conditions on a specified government test course. For example, a tire graded 150 would wear one and a half (1-1/2) times as well on the government course as a tire graded 100. The relative performance of tires depends upon the actual conditions of their use, however, and may depart significantly from the norm due to variations in driving habits, service practices and differences in road characteristics and climate.

Traction A, B, C—The traction grades, from highest to lowest, are A, B, and C, and they represent the tire's ability to stop on wet pavement as measured under controlled conditions on specified government test surfaces of asphalt and concrete. A tire marked C may have poor traction performance.

Warning: The traction grade assigned to this tire is based on braking (straight ahead) traction tests and does not include cornering (turning) traction.

Temperature A, B, C—The temperature grades are A (the highest), B, and C, representing the tire's resistance to the generation of heat and its ability to dissipate heat when tested under controlled conditions on a specific indoor laboratory test wheel. Sustained high temperature can cause the material of the tire to degenerate and reduce tire life, and excessive failure. The grade C corresponds to a level of performance which all passenger car tires must meet under the Federal Motor Vehicle Safety Standard No. 109. Grades B and A represent higher levels of performance on the laboratory test wheel than the minimum required by law.

Warning: The temperature grades for this tire are established for a tire that is properly inflated and not overloaded. Excessive speed, underinflation, or excessive loading, either separately or in combination, can cause heat buildup and possible tire failure.

Introduction

The scheduled maintenance information included in this supplement is provided as a guide to assist you in getting the greatest ownership value from your Toyota, while helping to maximize its performance, safety, and reliability. In addition to scheduled maintenance, your Toyota also requires ongoing general maintenance which includes checking fluid levels and simple visual inspections for potential signs of trouble. These items are explained separately in the “General Maintenance” section of your *Owner’s Manual*.

How much scheduled maintenance **your** Toyota requires depends on how you drive, as well as the environmental conditions in which you drive. The demands on vehicles can vary significantly depending on the driver, driving conditions, and geographic location. The following pages will assist you in determining the proper amount of maintenance for your Toyota so that you won’t have to pay for more maintenance than your Toyota needs. **Note:** Failure to properly maintain your vehicle can result in your warranty being voided either in whole or in part; please refer to the “New Vehicle Limited Warranty – Owner’s Responsibilities” section of this supplement for details.

The Scheduled Maintenance Log beginning on page 34 of this supplement allows you to easily identify the maintenance requirements at each mileage (or month) interval, while also providing a convenient place to document your vehicle’s maintenance history. Properly maintaining your Toyota and documenting its maintenance history can also help increase its resale value.

How to Use the Scheduled Maintenance Log

Oil Change Intervals

The Scheduled Maintenance Log has been designed to provide you with the flexibility to follow either 5,000-mile or 7,500-mile oil change intervals, depending on your circumstances.

- Use **5,000-mile** oil change intervals to help ensure proper engine lubrication under most driving conditions **or** for the following:
 - You **primarily** operate your Toyota under the “Special Operating Conditions” described on page 30 of this supplement.
 - Your Toyota is turbocharged.*

- Use **7,500-mile** oil change intervals if you **primarily** operate your **non-turbocharged** Toyota under light, non-commercial duty for distances greater than five miles in temperate climates (above freezing and below 90° F).

If you choose **5,000-mile** oil change intervals, simply follow the instructions printed in the non-shaded boxes as shown in this example:

5,000 MILES

If you choose **7,500-mile** oil change intervals, simply follow the instructions printed in the shaded boxes as shown in this example:

7,500 MILES

The **5,000-** and **7,500-mile** intervals coincide at 15,000-mile increments; therefore, both the shaded and non-shaded boxes are shown as in this example:

15,000 MILES
15,000 MILES

* **Note:** If a turbocharged Toyota is driven under the “Special Operating Conditions” described on page 30, then the oil change intervals should be further reduced to 2,500 miles.

SCHEDULED MAINTENANCE

30

Additional Maintenance Items for “Special Operating Conditions”

To assist you in getting the greatest ownership value from your Toyota, the Scheduled Maintenance Log separates the basic maintenance item requirements for most vehicles from the additional maintenance item requirements for vehicles that operate under more demanding “Special Operating Conditions.”

For the majority of owners who operate their Toyotas for personal use under normal conditions, the basic maintenance items listed in the upper section of the maintenance box should provide all the maintenance your Toyota needs. If you operate your Toyota **primarily** in any of the more demanding “Special Operating Conditions” listed in the next column, you should have the additional maintenance items indicated in the maintenance box performed on your Toyota. If you only **occasionally** operate your vehicle under these conditions, it is **not** necessary to perform the additional maintenance items.

Note: If you meet the requirements for 7,500-mile oil change intervals as indicated in the previous section, your Toyota should **not** require the additional maintenance items.

Special Operating Conditions:

1. Towing a trailer or using a camper or car-top carrier.
2. Repeated short trips of less than five miles in temperatures below freezing.
3. Extensive idling or low-speed driving for long distances as in heavy commercial use, such as delivery, taxi, or patrol car.
4. Operating on rough, muddy, or salt-covered roads.
5. Operating on unpaved or dusty roads.

Note: Turbocharged vehicles that are driven under the “Special Operating Conditions” listed above should change their engine oil at 2,500-mile intervals. It is not necessary, however, to change the oil filter at 2,500-mile intervals. Both the engine oil and filter should be replaced at the 5,000-mile intervals.

Example:

- Change **engine oil only** at 2,500, 7,500, 12,500...miles.
- Change engine oil **and filter** at 5,000, 10,000, 15,000...miles.

Explanation of Scheduled Maintenance Items

The following explanations are provided to give you a greater awareness and understanding of the individual maintenance items that should be performed on your Toyota to help ensure long life and top operating condition. The Scheduled Maintenance Log in the next section of this supplement identifies which of these maintenance items should be performed at each mileage/month interval.

Engine Components and Emission Control Systems

Timing Belt

If the vehicle is operated under extensive idling or low-speed driving for long distances as in heavy commercial use such as delivery, taxi, or patrol car, replace the timing belt every 60,000 miles. A qualified technician should perform this operation.

Valve Clearance

Inspect for excessive tappet noise and/or engine vibration and adjust if necessary. A qualified technician should perform this operation.

Drive Belts

Inspect the drive belts for cracks, excessive wear, or oiliness. Replace the belts if damaged, and check the belt tension and adjust it if necessary. After inspection at 60,000 miles or 48 months, inspect every 15,000 miles or 12 months.

Engine Oil and Oil Filter

Change the engine oil and oil filter when scheduled. Use API SH, Energy-Conserving II multigrade engine oil or ILSAC multigrade engine oil. For recommended viscosity, please refer to your *Owner's Manual*.

Engine Coolant

Drain and flush the cooling system when scheduled. Refill only with an ethylene-glycol type coolant. A qualified technician should perform this operation.

Exhaust Pipes and Mountings

Visually inspect the exhaust pipes, muffler, and hangers for cracks, deterioration, or damage. Start the engine and listen carefully for any exhaust gas leakage. Tighten connections or replace parts as necessary.

Engine Air Filter

Replace the engine air cleaner filter when scheduled.

SCHEDULED MAINTENANCE

32

Fuel Lines and Connections, Fuel Tank Vapor Vent System Hoses, and Fuel Tank Band

Visually inspect the lines, connections, hoses, and tank band for corrosion, damage, cracks, and loose or leaking connections. Tighten connections or replace parts as necessary.

Fuel Tank Cap Gasket

Visually inspect the fuel tank cap gasket for cracks, deterioration, or damage, and replace if necessary.

Spark Plugs

Install new plugs of the same type as originally equipped. A qualified technician should perform this operation.

Charcoal Canister

Inspect for internal damage or clogging as scheduled. Clean with compressed air or replace if necessary. A qualified technician should perform this operation.

Chassis and Body

Tire Rotation

To equalize tire wear and help extend tire life, Toyota recommends that you rotate your tires every 5,000 to 7,500 miles. However, the most appropriate timing for tire rotation may vary according to your driving habits and road surface conditions.

Brake Linings (Shoes and Pads), Drums and Discs

Check the brake linings (shoes) and drums for scoring, burning, leaking fluid, broken parts, and excessive wear. Check the pads for excessive wear and discs for runout and wear, and leaking fluid. A qualified technician should perform this operation.

Brake Lines and Hoses

Visually check for proper installation. Check for chafing, cracks, deterioration, and any evidence of leaking. Replace any deteriorated or damaged parts immediately. A qualified technician should perform these operations.

Steering Linkage

With the vehicle stopped, check for excessive freeplay in the steering wheel. Check the linkage for bending or damage. Check the dust boots for deterioration, cracks, or damage. Replace any damaged parts.

SRS Air Bags

After initial inspection at 120 months from the manufacture date on the certification label, inspect every 24 months. A qualified technician should perform this operation.

Rack and Pinion Assembly

Inspect the rack and pinion assemblies for signs of leakage. If you discover any leakage, have it repaired immediately by a qualified technician.

Ball Joints and Dust Covers

Check the suspension and steering linkage ball joints for looseness or damage. Check all dust covers for deterioration or damage. A qualified technician should perform this operation.

Drive Shaft Boots

Check the drive shaft boots and clamps for cracks, deterioration, or damage. Replace any damaged parts and, if necessary, repack the grease. For Camry, Avalon, and Supra, also re-torque the flange bolts (drive shaft to differential or side gear shaft). A qualified technician should perform these operations.

Manual Transmission Oil

Inspect each component for signs of leakage when scheduled. If you discover any leakage, have it repaired by a qualified technician immediately. If the vehicle is operated under the "Special Operating Conditions" defined on page 30 of this supplement, change the oil when scheduled.

Automatic Transmission and Differential Oil

Inspect each component for signs of leakage when scheduled. If you discover any leakage, have it repaired by a qualified technician immediately. If the vehicle is operated under the "Special Operating Conditions" defined on page 30 of this supplement, change the oil when scheduled.

Limited-Slip Differential Oil

Inspect every 15,000 miles or 12 months. Replace every 30,000 miles or 24 months. A qualified technician should perform this operation.

Wheel Bearing Grease

Repack the wheel bearings with wheel bearing grease.

Bolts and Nuts on Chassis and Body

If the vehicle is operated under the "Special Operating Conditions" defined on page 30 of this supplement, re-tighten the seat mounting bolts and front and rear suspension member retaining bolts to specified torque.

MAINTENANCE LOG

5,000 Miles or 4 Months*	10,000 Miles or 8 Months*
<input type="checkbox"/> Replace engine oil and oil filter <input type="checkbox"/> Rotate tires Additional Maintenance Items for Special Operating Conditions: Please refer to page 30 of this supplement to determine if your Toyota requires the additional maintenance items. <input type="checkbox"/> Inspect the following: ___ Air filter ___ Ball joints and dust covers ___ Brake: linings, discs/drums ___ Drive shaft boots (re-torque flange bolts) ___ Steering linkages ___ Body/chassis nuts and bolts Dealer Service Verification Date: _____ Mileage: _____	<input type="checkbox"/> Replace engine oil and oil filter <input type="checkbox"/> Rotate tires Additional Maintenance Items for Special Operating Conditions: Please refer to page 30 of this supplement to determine if your Toyota requires the additional maintenance items. <input type="checkbox"/> Inspect the following: ___ Air filter ___ Ball joints and dust covers ___ Brake: linings, discs/drums ___ Drive shaft boots (re-torque flange bolts) ___ Steering linkages ___ Body/chassis nuts and bolts Dealer Service Verification Date: _____ Mileage: _____
7,500 Miles or 6 Months*	
<input type="checkbox"/> Replace engine oil and oil filter <input type="checkbox"/> Rotate tires	Dealer Service Verification Date: _____ Mileage: _____

*Use the white background boxes to follow 5,000-mile oil change intervals or the shaded background boxes to follow 7,500-mile oil change intervals. Please refer to page 29 of this supplement for further information and to determine which interval is right for your driving circumstances.

5,000-Mile Oil Change Intervals

7,500-Mile Oil Change Intervals



15,000 Miles or 12 Months*									
15,000 Miles or 12 Months*									
<input type="checkbox"/> Replace engine oil and oil filter <input type="checkbox"/> Rotate tires <input type="checkbox"/> Inspect the following: <table style="width: 100%; border: none;"> <tr> <td style="width: 50%;">__ Exhaust pipes and mountings</td> <td style="width: 50%;">__ Ball joints and dust covers</td> </tr> <tr> <td>__ Brake: linings, discs/drums, lines, hoses</td> <td>__ Drive shaft boots (re-torque flange bolts)</td> </tr> <tr> <td>__ Steering linkages</td> <td>__ Automatic transmission and differential oil</td> </tr> <tr> <td>__ Rack and pinion assy. for leakage</td> <td>__ Limited-slip differential oil (Supra)</td> </tr> </table>		__ Exhaust pipes and mountings	__ Ball joints and dust covers	__ Brake: linings, discs/drums, lines, hoses	__ Drive shaft boots (re-torque flange bolts)	__ Steering linkages	__ Automatic transmission and differential oil	__ Rack and pinion assy. for leakage	__ Limited-slip differential oil (Supra)
__ Exhaust pipes and mountings	__ Ball joints and dust covers								
__ Brake: linings, discs/drums, lines, hoses	__ Drive shaft boots (re-torque flange bolts)								
__ Steering linkages	__ Automatic transmission and differential oil								
__ Rack and pinion assy. for leakage	__ Limited-slip differential oil (Supra)								
<p><i>Additional Maintenance Items for Special Operating Conditions:</i> Please refer to page 30 of this supplement to determine if your Toyota requires the additional maintenance items.</p> <input type="checkbox"/> Inspect air filter <input type="checkbox"/> Replace automatic transmission and differential oil <input type="checkbox"/> Inspect body/chassis nuts and bolts									
<div style="border: 1px solid black; padding: 5px; margin-bottom: 10px;"> <p style="text-align: center;"><i>Dealer Service Verification</i></p> </div>	Date: _____ Mileage: _____								

MAINTENANCE LOG

36

20,000 Miles or 16 Months*	25,000 Miles or 20 Months*
<input type="checkbox"/> Replace engine oil and oil filter <input type="checkbox"/> Rotate tires Additional Maintenance Items for Special Operating Conditions: Please refer to page 30 of this supplement to determine if your Toyota requires the additional maintenance items. <input type="checkbox"/> Inspect the following: ___ Air filter ___ Ball joints and dust covers ___ Brake: linings, discs/drums ___ Drive shaft boots (re-torque flange bolts) ___ Steering linkages ___ Body/chassis nuts and bolts <div data-bbox="94 511 490 663">Dealer Service Verification Date: _____ Mileage: _____</div>	<input type="checkbox"/> Replace engine oil and oil filter <input type="checkbox"/> Rotate tires Additional Maintenance Items for Special Operating Conditions: Please refer to page 30 of this supplement to determine if your Toyota requires the additional maintenance items. <input type="checkbox"/> Inspect the following: ___ Air filter ___ Ball joints and dust covers ___ Brake: linings, discs/drums ___ Drive shaft boots (re-torque flange bolts) ___ Steering linkages ___ Body/chassis nuts and bolts <div data-bbox="857 511 1253 663">Dealer Service Verification Date: _____ Mileage: _____</div>
22,500 Miles or 18 Months*	
<input type="checkbox"/> Replace engine oil and oil filter <input type="checkbox"/> Rotate tires	<div data-bbox="604 742 1000 894">Dealer Service Verification Date: _____ Mileage: _____</div>

*Use the white background boxes to follow 5,000-mile oil change intervals or the shaded background boxes to follow 7,500-mile oil change intervals. Please refer to page 29 of this supplement for further information and to determine which interval is right for your driving circumstances.

5,000-Mile Oil Change Intervals

7,500-Mile Oil Change Intervals



30,000 Miles or 24 Months*	
30,000 Miles or 24 Months*	
<input type="checkbox"/> Replace engine oil and oil filter <input type="checkbox"/> Rotate tires <input type="checkbox"/> Replace engine air filter <input type="checkbox"/> Replace non-platinum spark plugs ¹ - Celica (7AFE), Corolla, Paseo, Tercel <input type="checkbox"/> Inspect the following: — Fuel lines and connections, fuel tank vapor vent system hoses, fuel tank band — Fuel tank cap gasket — Exhaust pipes and mountings — Brake: linings, discs/drums, lines, hoses	<input type="checkbox"/> Replace engine coolant <input type="checkbox"/> Repack rear wheel bearings (Tercel, Paseo) <input type="checkbox"/> Replace limited-slip differential oil (Supra) — Steering linkages — Rack and pinion assy. for leakage — Ball joints and dust covers — Drive shaft boots (re-torque flange bolts) — Transmission and differential oil
<p><i>Additional Maintenance Items for Special Operating Conditions:</i> Please refer to page 30 of this supplement to determine if your Toyota requires the additional maintenance items.</p> <input type="checkbox"/> Replace transmission and differential oil <input type="checkbox"/> Inspect body/chassis nuts and bolts	
<div style="border: 1px solid black; width: 250px; height: 40px; margin-bottom: 10px;"></div> <p style="margin: 0;"><i>Dealer Service Verification</i></p> <p style="margin: 0;">Date: _____</p> <p style="margin: 0;">Mileage: _____</p>	

¹ Maintenance service is required under the terms of the Emission Control Warranty.

MAINTENANCE LOG

38

35,000 Miles or 28 Months*	40,000 Miles or 32 Months*
<input type="checkbox"/> Replace engine oil and oil filter <input type="checkbox"/> Rotate tires Additional Maintenance Items for Special Operating Conditions: Please refer to page 30 of this supplement to determine if your Toyota requires the additional maintenance items. <input type="checkbox"/> Inspect the following: ___ Air filter ___ Ball joints and dust covers ___ Brake: linings, discs/drums ___ Drive shaft boots (re-torque flange bolts) ___ Steering linkages ___ Body/chassis nuts and bolts Dealer Service Verification Date: _____ Mileage: _____	<input type="checkbox"/> Replace engine oil and oil filter <input type="checkbox"/> Rotate tires Additional Maintenance Items for Special Operating Conditions: Please refer to page 30 of this supplement to determine if your Toyota requires the additional maintenance items. <input type="checkbox"/> Inspect the following: ___ Air filter ___ Ball joints and dust covers ___ Brake: linings, discs/drums ___ Drive shaft boots (re-torque flange bolts) ___ Steering linkages ___ Body/chassis nuts and bolts Dealer Service Verification Date: _____ Mileage: _____
37,500 Miles or 30 Months*	
<input type="checkbox"/> Replace engine oil and oil filter <input type="checkbox"/> Rotate tires	Dealer Service Verification Date: _____ Mileage: _____

*Use the white background boxes to follow 5,000-mile oil change intervals or the shaded background boxes to follow 7,500-mile oil change intervals. Please refer to page 29 of this supplement for further information and to determine which interval is right for your driving circumstances.

5,000-Mile Oil Change Intervals

7,500-Mile Oil Change Intervals



45,000 Miles or 36 Months*	
45,000 Miles or 36 Months*	
<input type="checkbox"/> Replace engine oil and oil filter	
<input type="checkbox"/> Rotate tires	
<input type="checkbox"/> Inspect the following:	
___ Exhaust pipes and mountings	___ Ball joints and dust covers
___ Brake: linings, discs/drums, lines, hoses	___ Drive shaft boots (re-torque flange bolts)
___ Steering linkages	___ Automatic transmission and differential oil
___ Rack and pinion assy. for leakage	___ Limited-slip differential oil (Supra)
<i>Additional Maintenance Items for Special Operating Conditions:</i>	
Please refer to page 30 of this supplement to determine if your Toyota requires the additional maintenance items.	
<input type="checkbox"/> Inspect air filter	
<input type="checkbox"/> Replace automatic transmission and differential oil	
<input type="checkbox"/> Inspect body/chassis nuts and bolts	
<i>Dealer Service Verification</i>	
Date: _____	
Mileage: _____	

MAINTENANCE LOG

40

50,000 Miles or 40 Months*	55,000 Miles or 44 Months*												
<p><input type="checkbox"/> Replace engine oil and oil filter</p> <p><input type="checkbox"/> Rotate tires</p> <p>Additional Maintenance Items for Special Operating Conditions: Please refer to page 30 of this supplement to determine if your Toyota requires the additional maintenance items.</p> <p><input type="checkbox"/> Inspect the following:</p> <table border="0"><tr><td><input type="checkbox"/> Air filter</td><td><input type="checkbox"/> Ball joints and dust covers</td></tr><tr><td><input type="checkbox"/> Brake: linings, discs/drums</td><td><input type="checkbox"/> Drive shaft boots (re-torque flange bolts)</td></tr><tr><td><input type="checkbox"/> Steering linkages</td><td><input type="checkbox"/> Body/chassis nuts and bolts</td></tr></table> <p>Dealer Service Verification</p> <p>Date: _____</p> <p>Mileage: _____</p>	<input type="checkbox"/> Air filter	<input type="checkbox"/> Ball joints and dust covers	<input type="checkbox"/> Brake: linings, discs/drums	<input type="checkbox"/> Drive shaft boots (re-torque flange bolts)	<input type="checkbox"/> Steering linkages	<input type="checkbox"/> Body/chassis nuts and bolts	<p><input type="checkbox"/> Replace engine oil and oil filter</p> <p><input type="checkbox"/> Rotate tires</p> <p>Additional Maintenance Items for Special Operating Conditions: Please refer to page 30 of this supplement to determine if your Toyota requires the additional maintenance items.</p> <p><input type="checkbox"/> Inspect the following:</p> <table border="0"><tr><td><input type="checkbox"/> Air filter</td><td><input type="checkbox"/> Ball joints and dust covers</td></tr><tr><td><input type="checkbox"/> Brake: linings, discs/drums</td><td><input type="checkbox"/> Drive shaft boots (re-torque flange bolts)</td></tr><tr><td><input type="checkbox"/> Steering linkages</td><td><input type="checkbox"/> Body/chassis nuts and bolts</td></tr></table> <p>Dealer Service Verification</p> <p>Date: _____</p> <p>Mileage: _____</p>	<input type="checkbox"/> Air filter	<input type="checkbox"/> Ball joints and dust covers	<input type="checkbox"/> Brake: linings, discs/drums	<input type="checkbox"/> Drive shaft boots (re-torque flange bolts)	<input type="checkbox"/> Steering linkages	<input type="checkbox"/> Body/chassis nuts and bolts
<input type="checkbox"/> Air filter	<input type="checkbox"/> Ball joints and dust covers												
<input type="checkbox"/> Brake: linings, discs/drums	<input type="checkbox"/> Drive shaft boots (re-torque flange bolts)												
<input type="checkbox"/> Steering linkages	<input type="checkbox"/> Body/chassis nuts and bolts												
<input type="checkbox"/> Air filter	<input type="checkbox"/> Ball joints and dust covers												
<input type="checkbox"/> Brake: linings, discs/drums	<input type="checkbox"/> Drive shaft boots (re-torque flange bolts)												
<input type="checkbox"/> Steering linkages	<input type="checkbox"/> Body/chassis nuts and bolts												
52,500 Miles or 42 Months*													
<p><input type="checkbox"/> Replace engine oil and oil filter</p> <p><input type="checkbox"/> Rotate tires</p>	<p>Dealer Service Verification</p> <p>Date: _____</p> <p>Mileage: _____</p>												

*Use the white background boxes to follow 5,000-mile oil change intervals or the shaded background boxes to follow 7,500-mile oil change intervals. Please refer to page 29 of this supplement for further information and to determine which interval is right for your driving circumstances.

5,000-Mile Oil Change Intervals

7,500-Mile Oil Change Intervals



60,000 Miles or 48 Months*	
60,000 Miles or 48 Months*	
<input type="checkbox"/> Replace engine oil and oil filter <input type="checkbox"/> Rotate tires <input type="checkbox"/> Replace engine air filter <input type="checkbox"/> Replace spark plugs ¹ <input type="checkbox"/> Inspect the following: ___ Valves (audible inspection), adjust if necessary ___ Drive belts ___ Fuel lines and connections, fuel tank vapor vent system hoses, fuel tank band ___ Fuel tank cap gasket ___ Charcoal canister (72 months) ²	<input type="checkbox"/> Replace engine coolant <input type="checkbox"/> Repack rear wheel bearings (Tercel, Paseo) <input type="checkbox"/> Replace limited-slip differential oil (Supra) ___ Exhaust pipes and mountings ___ Brake: linings, discs/drums, lines, hoses ___ Steering linkages ___ Rack and pinion assy. for leakage ___ Ball joints and dust covers ___ Drive shaft boots (re-torque flange bolts) ___ Transmission and differential oil
<p>Additional Maintenance Items for Special Operating Conditions: Please refer to page 30 of this supplement to determine if your Toyota requires the additional maintenance items.</p> <input type="checkbox"/> Replace timing belt ³ <input type="checkbox"/> Replace transmission and differential oil <input type="checkbox"/> Inspect body/chassis nuts and bolts	
<div style="border: 1px solid black; height: 100px; width: 100%;"></div> <p style="text-align: center;">Dealer Service Verification</p>	Date: _____ Mileage: _____

¹ Maintenance service is required under the terms of the Emission Control Warranty.
² Non-maintenance item except for CA, MA, NY.
³ Timing belt replacement only required for Special Operating Condition 3 as indicated on page 30 of this supplement.

MAINTENANCE LOG

42

65,000 Miles or 52 Months*	70,000 Miles or 56 Months*
<input type="checkbox"/> Replace engine oil and oil filter <input type="checkbox"/> Rotate tires Additional Maintenance Items for Special Operating Conditions: Please refer to page 30 of this supplement to determine if your Toyota requires the additional maintenance items. <input type="checkbox"/> Inspect the following: ___ Air filter ___ Ball joints and dust covers ___ Brake: linings, discs/drums ___ Drive shaft boots (re-torque flange bolts) ___ Steering linkages ___ Body/chassis nuts and bolts <div data-bbox="94 510 490 665">Dealer Service Verification Date: _____ Mileage: _____</div>	<input type="checkbox"/> Replace engine oil and oil filter <input type="checkbox"/> Rotate tires Additional Maintenance Items for Special Operating Conditions: Please refer to page 30 of this supplement to determine if your Toyota requires the additional maintenance items. <input type="checkbox"/> Inspect the following: ___ Air filter ___ Ball joints and dust covers ___ Brake: linings, discs/drums ___ Drive shaft boots (re-torque flange bolts) ___ Steering linkages ___ Body/chassis nuts and bolts <div data-bbox="857 510 1253 665">Dealer Service Verification Date: _____ Mileage: _____</div>
67,500 Miles or 54 Months*	
<input type="checkbox"/> Replace engine oil and oil filter <input type="checkbox"/> Rotate tires	<div data-bbox="604 742 998 895">Dealer Service Verification Date: _____ Mileage: _____</div>

*Use the white background boxes to follow 5,000-mile oil change intervals or the shaded background boxes to follow 7,500-mile oil change intervals. Please refer to page 29 of this supplement for further information and to determine which interval is right for your driving circumstances.

5,000-Mile Oil Change Intervals

7,500-Mile Oil Change Intervals



75,000 Miles or 60 Months*	
75,000 Miles or 60 Months*	
<input type="checkbox"/> Replace engine oil and oil filter	
<input type="checkbox"/> Rotate tires	
<input type="checkbox"/> Inspect the following:	
___ Exhaust pipes and mountings	___ Ball joints and dust covers
___ Brake: linings, discs/drums, lines, hoses	___ Drive shaft boots (re-torque flange bolts)
___ Steering linkages	___ Automatic transmission and differential oil
___ Rack and pinion assy. for leakage	___ Limited-slip differential oil (Supra)
<i>Additional Maintenance Items for Special Operating Conditions:</i>	
Please refer to page 30 of this supplement to determine if your Toyota requires the additional maintenance items.	
<input type="checkbox"/> Inspect air filter	
<input type="checkbox"/> Replace automatic transmission and differential oil	
<input type="checkbox"/> Inspect body/chassis nuts and bolts	
<i>Dealer Service Verification</i>	
Date: _____	
Mileage: _____	

MAINTENANCE LOG

80,000 Miles or 64 Months*	85,000 Miles or 68 Months*
<input type="checkbox"/> Replace engine oil and oil filter <input type="checkbox"/> Rotate tires Additional Maintenance Items for Special Operating Conditions: Please refer to page 30 of this supplement to determine if your Toyota requires the additional maintenance items. <input type="checkbox"/> Inspect the following: ___ Air filter ___ Ball joints and dust covers ___ Brake: linings, discs/drums ___ Drive shaft boots (re-torque flange bolts) ___ Steering linkages ___ Body/chassis nuts and bolts Dealer Service Verification Date: _____ Mileage: _____	<input type="checkbox"/> Replace engine oil and oil filter <input type="checkbox"/> Rotate tires Additional Maintenance Items for Special Operating Conditions: Please refer to page 30 of this supplement to determine if your Toyota requires the additional maintenance items. <input type="checkbox"/> Inspect the following: ___ Air filter ___ Ball joints and dust covers ___ Brake: linings, discs/drums ___ Drive shaft boots (re-torque flange bolts) ___ Steering linkages ___ Body/chassis nuts and bolts Dealer Service Verification Date: _____ Mileage: _____
82,500 Miles or 66 Months*	
<input type="checkbox"/> Replace engine oil and oil filter <input type="checkbox"/> Rotate tires	Dealer Service Verification Date: _____ Mileage: _____

*Use the white background boxes to follow 5,000-mile oil change intervals or the shaded background boxes to follow 7,500-mile oil change intervals. Please refer to page 29 of this supplement for further information and to determine which interval is right for your driving circumstances.

5,000-Mile Oil Change Intervals

7,500-Mile Oil Change Intervals



90,000 Miles or 72 Months*	
90,000 Miles or 72 Months*	
<input type="checkbox"/> Replace engine oil and oil filter <input type="checkbox"/> Rotate tires <input type="checkbox"/> Replace engine air filter <input type="checkbox"/> Replace non-platinum spark plugs ¹ - Celica (7AFE), Corolla, Paseo, Tercel <input type="checkbox"/> Inspect the following: __ Drive belts __ Fuel lines and connections, fuel tank vapor vent system hoses, fuel tank band __ Fuel tank cap gasket __ Exhaust pipes and mountings __ Brake: linings, discs/drums, lines, hoses	<input type="checkbox"/> Replace engine coolant <input type="checkbox"/> Repack rear wheel bearings (Tercel, Paseo) <input type="checkbox"/> Replace limited-slip differential oil (Supra) __ Steering linkages __ Rack and pinion assy. for leakage __ Ball joints and dust covers __ Drive shaft boots (re-torque flange bolts) __ Transmission and differential oil
<p><i>Additional Maintenance Items for Special Operating Conditions:</i> Please refer to page 30 of this supplement to determine if your Toyota requires the additional maintenance items.</p> <input type="checkbox"/> Replace transmission and differential oil <input type="checkbox"/> Inspect body/chassis nuts and bolts	
<div style="border: 1px solid black; height: 100px; width: 100%; margin-bottom: 5px;"></div> <p style="text-align: center;"><i>Dealer Service Verification</i></p>	<p>Date: _____</p> <p>Mileage: _____</p>

¹ Maintenance service is required under the terms of the Emission Control Warranty.

MAINTENANCE LOG

46

95,000 Miles or 76 Months*	100,000 Miles or 80 Months*
<input type="checkbox"/> Replace engine oil and oil filter <input type="checkbox"/> Rotate tires Additional Maintenance Items for Special Operating Conditions: Please refer to page 30 of this supplement to determine if your Toyota requires the additional maintenance items. <input type="checkbox"/> Inspect the following: ___ Air filter ___ Ball joints and dust covers ___ Brake: linings, discs/drums ___ Drive shaft boots (re-torque flange bolts) ___ Steering linkages ___ Body/chassis nuts and bolts Dealer Service Verification Date: _____ Mileage: _____	<input type="checkbox"/> Replace engine oil and oil filter <input type="checkbox"/> Rotate tires Additional Maintenance Items for Special Operating Conditions: Please refer to page 30 of this supplement to determine if your Toyota requires the additional maintenance items. <input type="checkbox"/> Inspect the following: ___ Air filter ___ Ball joints and dust covers ___ Brake: linings, discs/drums ___ Drive shaft boots (re-torque flange bolts) ___ Steering linkages ___ Body/chassis nuts and bolts Dealer Service Verification Date: _____ Mileage: _____
97,500 Miles or 78 Months*	
<input type="checkbox"/> Replace engine oil and oil filter <input type="checkbox"/> Rotate tires	Dealer Service Verification Date: _____ Mileage: _____

*Use the white background boxes to follow 5,000-mile oil change intervals or the shaded background boxes to follow 7,500-mile oil change intervals. Please refer to page 29 of this supplement for further information and to determine which interval is right for your driving circumstances.

5,000-Mile Oil Change Intervals

7,500-Mile Oil Change Intervals



105,000 Miles or 84 Months*	
105,000 Miles or 84 Months*	
<input type="checkbox"/> Replace engine oil and oil filter	
<input type="checkbox"/> Rotate tires	
<input type="checkbox"/> Inspect the following:	
___ Drive belts	___ Ball joints and dust covers
___ Exhaust pipes and mountings	___ Drive shaft boots (re-torque flange bolts)
___ Brake: linings, discs/drums, lines, hoses	___ Automatic transmission and differential oil
___ Steering linkages	___ Limited-slip differential oil (Supra)
___ Rack and pinion assy. for leakage	
<i>Additional Maintenance Items for Special Operating Conditions:</i>	
Please refer to page 30 of this supplement to determine if your Toyota requires the additional maintenance items.	
<input type="checkbox"/> Inspect air filter	
<input type="checkbox"/> Replace automatic transmission and differential oil	
<input type="checkbox"/> Inspect body/chassis nuts and bolts	
<i>Dealer Service Verification</i>	
Date: _____	
Mileage: _____	

MAINTENANCE LOG

48

110,000 Miles or 88 Months*	115,000 Miles or 92 Months*
<input type="checkbox"/> Replace engine oil and oil filter <input type="checkbox"/> Rotate tires Additional Maintenance Items for Special Operating Conditions: Please refer to page 30 of this supplement to determine if your Toyota requires the additional maintenance items. <input type="checkbox"/> Inspect the following: ___ Air filter ___ Ball joints and dust covers ___ Brake: linings, discs/drums ___ Drive shaft boots (re-torque flange bolts) ___ Steering linkages ___ Body/chassis nuts and bolts <div data-bbox="94 511 490 663" style="border: 1px solid black; padding: 5px;">Dealer Service Verification</div> Date: _____ Mileage: _____	<input type="checkbox"/> Replace engine oil and oil filter <input type="checkbox"/> Rotate tires Additional Maintenance Items for Special Operating Conditions: Please refer to page 30 of this supplement to determine if your Toyota requires the additional maintenance items. <input type="checkbox"/> Inspect the following: ___ Air filter ___ Ball joints and dust covers ___ Brake: linings, discs/drums ___ Drive shaft boots (re-torque flange bolts) ___ Steering linkages ___ Body/chassis nuts and bolts <div data-bbox="857 511 1253 663" style="border: 1px solid black; padding: 5px;">Dealer Service Verification</div> Date: _____ Mileage: _____
112,500 Miles or 90 Months*	
<input type="checkbox"/> Replace engine oil and oil filter <input type="checkbox"/> Rotate tires	<div data-bbox="604 742 1000 894" style="border: 1px solid black; padding: 5px;">Dealer Service Verification</div> Date: _____ Mileage: _____

*Use the white background boxes to follow 5,000-mile oil change intervals or the shaded background boxes to follow 7,500-mile oil change intervals. Please refer to page 29 of this supplement for further information and to determine which interval is right for your driving circumstances.

5,000-Mile Oil Change Intervals

7,500-Mile Oil Change Intervals



120,000 Miles or 96 Months*	
120,000 Miles or 96 Months*	
<input type="checkbox"/> Replace engine oil and oil filter <input type="checkbox"/> Rotate tires <input type="checkbox"/> Replace engine air filter <input type="checkbox"/> Replace spark plugs ¹ <input type="checkbox"/> Inspect the following: ___ Valves (audible inspection), adjust if necessary ___ Drive belts ___ Fuel lines and connections, fuel tank vapor vent system hoses, fuel tank band ___ Fuel tank cap gasket ___ Charcoal canister (144 months) ² ___ Exhaust pipes and mountings	<input type="checkbox"/> Replace engine coolant <input type="checkbox"/> Repack rear wheel bearings (Tercel, Paseo) <input type="checkbox"/> Replace limited-slip differential oil (Supra) ___ Brake: linings, discs/drums, lines, hoses ___ Steering linkages ___ Rack and pinion assy. for leakage ___ Ball joints and dust covers ___ Drive shaft boots (re-torque flange bolts) ___ Transmission and differential oil
<p>Additional Maintenance Items for Special Operating Conditions: Please refer to page 30 of this supplement to determine if your Toyota requires the additional maintenance items.</p> <input type="checkbox"/> Replace timing belt ³ <input type="checkbox"/> Replace transmission and differential oil <input type="checkbox"/> Inspect body/chassis nuts and bolts	
<div style="border: 1px solid black; padding: 5px; width: fit-content; margin: 0 auto;">Dealer Service Verification</div>	Date: _____ Mileage: _____

120 Months	
120 Months	
<input type="checkbox"/> Inspect SRS Air Bag	
<div style="border: 1px solid black; padding: 5px; width: fit-content; margin: 0 auto;">Dealer Service Verification</div>	Date: _____ Mileage: _____

¹ Maintenance service is required under the terms of the Emission Control Warranty.
² Non-maintenance item except for CA, MA, NY.
³ Timing belt replacement only required for Special Operating Condition 3 as indicated on page 30 of this supplement.

SERVICE MANUALS

50

Official Toyota Service Manuals

You may prefer to do some of your own service work on your Toyota. Or, you may want to be more knowledgeable when you talk about your Toyota with the service writer or service manager at the dealership. In either case, we have the service manuals with the information you need.

A complete line of Service Manuals is available for your Toyota, including the Repair Manual, Electrical Wiring Diagram, Automatic Transmission/Transaxle Repair Manual, and replacement *Owner's Manuals*, if needed.

For owners who wish to perform their own maintenance and light repair, a new Do-It-Yourself Repair Manual is available for Camry and Tacoma models.

Vehicle Repair Manual

These are the same service and repair manuals used by professional technicians in Toyota dealerships throughout the U.S. They are fully illustrated and cover each of your vehicle's systems in considerable detail.

- Tune-up instructions and specifications.
- Repair procedures for all vehicle mechanical systems, e.g., brakes, engine, transmission, and chassis.

Repair Manual Supplements

- Electrical Systems book provides detailed electrical wiring diagrams for each electrical system in your vehicle.
- Automatic Transmission/Transaxle Overhaul book covers procedures for overhaul of the automatic transmission/transaxle of your vehicle.

Do-It-Yourself Repair Manual

- Maintenance instructions.
- Light repair procedures for commonly performed owner repairs.

Ordering Procedures

If you wish to order one or more of the manuals, simply fill out both sides of the order form, cut it out, and mail it to us, or you can phone direct. If you are in any way dissatisfied with your order, return it within 10 days for a full refund.

If you wish to place a CREDIT CARD ORDER by telephone, please have your credit card handy when calling.

Only credit card orders can be accepted by phone.

Toyota Service Publications
1-800-622-2033

VEHICLE IDENTIFICATION

Model	Model Year
Body Style	
Vehicle I.D. Number	
In-Service Date	
Mileage at Delivery	
Key Number	
Selling Dealer's Name	
Dealer Code	

SPEEDOMETER REPLACEMENT RECORD

Speedometer Replaced on	(Date)
with	Miles on the Odometer
Toyota Dealer Signature	

OWNER IDENTIFICATION

53

Name		
Address		
City	State	ZIP
Telephone		

NOTES:

NOTES:

NOTES:

NOTES:



**WE REALLY CARE ABOUT YOU –
PLEASE BUCKLE UP.**

Toyota has made a special effort to encourage use of seat belts.

Toyota belts are:

- Comfortable
- Easy to use
- Convenient

We encourage you to use your belts every time you drive.

00404-01997-TRK
Printed in U.S.A.
07/96

00404-01997-CAR
Printed in U.S.A.
07/96

Table of Contents

In this manual you will find:

Warranty at a Glance	1
The Toyota Touch	2
How to Get Assistance	3
New Vehicle Limited Warranty	
• What Is Covered	4
• What Is Not Covered	6
• Owner's Responsibilities	7
Federal Emission Warranty	9
California Emission Control Warranty	13
Tire Limited Warranty	17
Arbitration	18
Seat Belt/Audio Systems	21
Extended Protection for Your Vehicle	22
Parts and Service	23
Toyota Parts Centers	24
Toyota Express Lube	25
Lifetime Guarantee Program	26
Genuine Toyota Fluids	27
Dealer Certificate	28
Scheduled Maintenance	29
Maintenance Log	34
Service Manuals	50
Vehicle Identification/ Owner Identification	53

1 9 9 7

OWNER'S
MANUAL
SUPPLEMENT

PART 1



Passenger Car

This Is a Supplement to Your Owner's Manual

- Keep this manual in your vehicle. In it you will find warranties and information about Toyota parts and service, as well as how to maintain your new Toyota.
- Warranty information is provided to protect your investment and outlines procedures for solving any problem you may have with your new Toyota. Your *Owner's Manual* also contains important information. Be sure to read it carefully.
- Maintenance information for your Toyota is provided in the **Scheduled Maintenance** section of this supplement. This section clearly indicates the minimum maintenance requirements for your Toyota based on your driving habits and operating conditions.

- The **Scheduled Maintenance** section of this supplement also includes a Maintenance Log which clearly identifies the specific maintenance requirements for each mileage interval while providing you with a convenient place to document your Toyota's maintenance history.
- All information is based on the latest data available at time of publication and is subject to change without notice, except the emissions warranty.
- Please be aware that any modification to your Toyota could affect its performance, safety, or durability, and may even violate government regulations.

- Please be aware that the failure to follow procedures specified in the Owner's Manual and this supplement could result in voiding the warranty in whole or in part.
- To further demonstrate our commitment to your satisfaction with your Toyota vehicle, there may be times when Toyota will establish a special policy adjustment for your particular vehicle model which will pay for all or part of the costs of certain repairs beyond normal warranty coverage.

For more details please call your dealership or call Toyota toll-free at 1-800-331-4331.

WARRANTY AT A GLANCE

WARRANTY COVERAGE

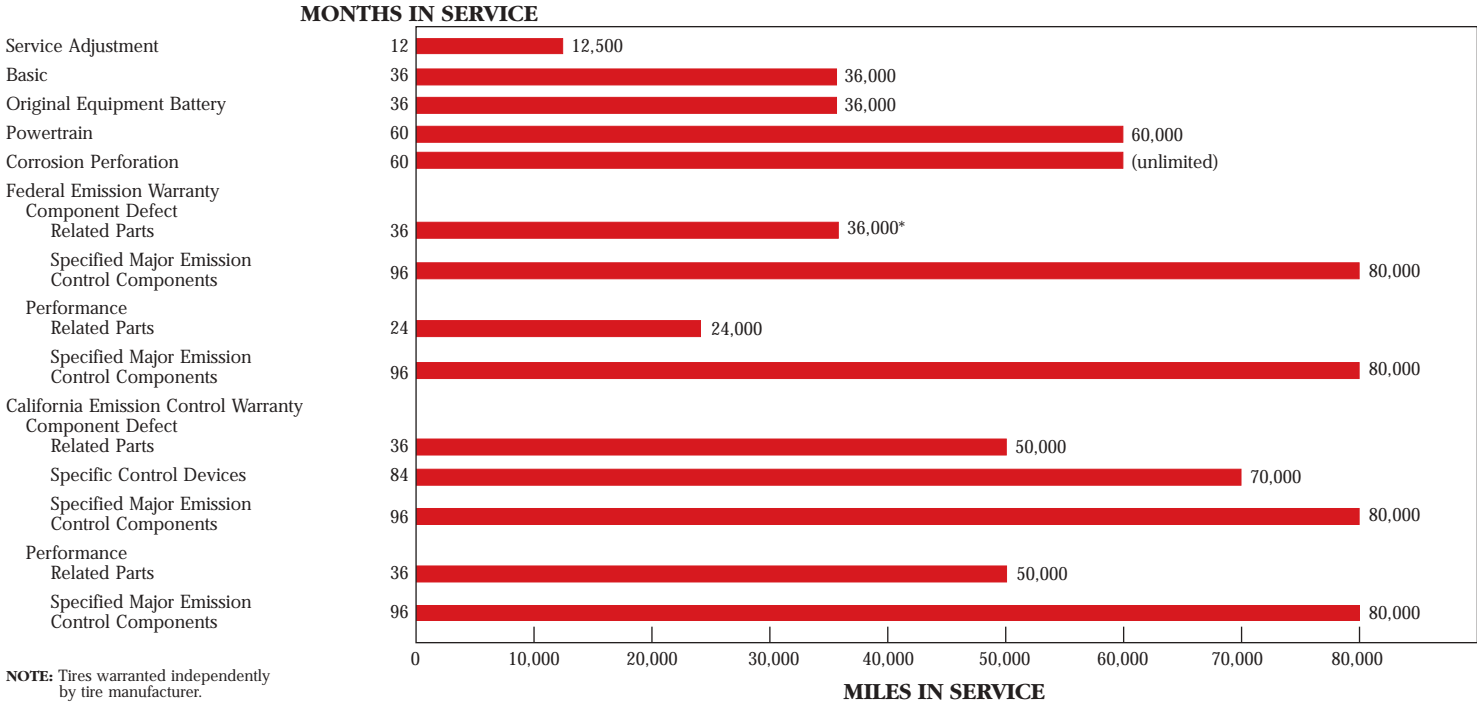

NOTE: Tires warranted independently by tire manufacturer.

* Federal Environmental Protection Agency (EPA) regulations require a coverage of 2 years/24,000 miles for emission control components. However, Toyota will provide a coverage of 3 years/36,000 miles under terms of the Basic Warranty. In addition, specific components may be entitled to additional coverage under terms of the Powertrain Warranty.

THE TOYOTA TOUCH

2

What Is the Toyota Touch?

It is our commitment to you. When you purchase a Toyota car, truck, sport utility vehicle, or van, we want you to derive even more satisfaction and receive even more value than you expect.

The Toyota Touch begins with design and engineering that leads the automobile industry in quality, innovation, economy, reliability, styling, and performance. Our 36 month/36,000 mile limited basic warranty coverage, with longer limited warranty coverage for specific components, further demonstrates this commitment to you—the customer. Throughout this lengthy warranty period, we are there to stand behind our product quality and YOU.

In addition to our lengthy limited warranty, the Toyota Touch is our commitment to treat you the way you want to be treated. It means that every step of the way, from your first visit or phone call to a Toyota dealer, through purchase and delivery, to after-sales service, we're committed to the spirit as well as the letter of courteous, fair, and reasonable treatment.

The Toyota Touch is our way of doing business with you. It's as simple as a smile, a handshake, and a promise kept.

HAVE A QUESTION OR PROBLEM?

Just ask for our

Customer Relations Manager.

YOUR SATISFACTION IS #1 WITH US.

THE 
TOYOTA TOUCH

To Our Customers

Toyota has a commitment to you and your satisfaction. From your first phone call or visit to the dealership, through the purchase and delivery of your new Toyota, to after-sales service, your satisfaction is Number One with us.

If you should experience a problem or concern, either within or outside of the warranty period, please follow these procedures in the sequence listed for the fastest possible response.

Step 1: Contact the Dealership Customer Relations Manager

If you have a question, concern, or complaint, just ask for the dealership Customer Relations Manager. This person has been specially trained to understand the customer's point of view when a question or problem arises.

The Customer Relations Manager has the responsibility to resolve most cases and will make every effort to conduct a fair review of your situation.

Note: For information regarding specific state regulations and notices, see the *Toyota Owner's Manual Supplement Part 2* in your vehicle glove box.

Step 2: Call the Toyota Customer Assistance Center

If for any reason you still need assistance after contacting the dealership Customer Relations Manager, please call Toyota's Customer Assistance Center toll-free at:

1-800-331-4331

For our hearing and/or speech impaired customers, please call toll-free at:

1-800-443-4999 (TDD)

A Toyota Customer Assistance Representative will review your request and help with any further questions or problems you may have regarding your vehicle warranty or any special policy adjustments.

Note: In order to give you the greatest assistance possible, please help us by providing the following information when you call:

- Vehicle Identification Number. (You will find this 17-digit number located on the driver's side corner of the dash under the window. It is also listed on your sales contract/invoice.)
- Current mileage on your Toyota (if applicable).
- Names of the selling and servicing dealerships.
- Your daytime and evening phone numbers.

Step 3: Arbitration

If you should experience a problem which has not been resolved to your satisfaction through Steps 1 and 2, Toyota offers additional assistance through the Council of Better Business Bureaus' (CBBBs') BBB AUTO LINE arbitration program. CBBB serves as the administrator of the BBB AUTO LINE program. All arbitrators and technical experts are employed through BBB AUTO LINE.

BBB AUTO LINE will resolve your complaint through arbitration — a process by which two or more parties authorize an independent third party to resolve the dispute.

This procedure is quick, easy to use, and offered to you at no cost.

Please refer to the New Vehicle Limited Warranty for additional information regarding the arbitration process.

Note: In Canada, assistance may be obtained from:
Toyota Customer Service Office
Toyota Canada Inc.
One Toyota Place
Scarborough, Ontario M1H1H9
Canada
1-800-263-7640 (Canada only)

NEW VEHICLE LIMITED WARRANTY

4

What Is Covered

Warrantor

TOYOTA warrants each new 1997 vehicle. For the purpose of warranty in the mainland United States and Alaska, TOYOTA is Toyota Motor Sales, U.S.A., Inc. (a California corporation).

Warranty Application

This warranty is applicable to any vehicle registered and normally operated in the mainland United States, Alaska, and Canada only.

No Charge

Warranty repairs and adjustments (parts and/or labor) will be made at no charge.

Fully Transferable

Warranty coverage is fully transferable at no cost to subsequent vehicle owners.

Warranty Begins

The warranty period begins on the date the vehicle is first delivered or put into use (in-service date).

Any implied warranty of merchantability or fitness for a particular purpose applicable to this vehicle is limited to the duration of the written warranty. Some states do not allow limitations on how long an implied warranty lasts, so the above limitation may not apply to you.

Arbitration

In the unlikely event a dispute arises as to your warranty coverage, Toyota offers dispute resolution through arbitration provided by:

BBB AUTO LINE
4200 Wilson Blvd., Suite 800
Arlington, VA 22203

Arbitration is available to you free of charge. BBB AUTO LINE is designed to render a decision within 40 days from BBB AUTO LINE's receipt of your request for arbitration. BBB AUTO LINE's decision is binding on Toyota but not on you.

IMPORTANT: You *must* use BBB AUTO LINE prior to seeking remedies available to you through a court action pursuant to the Magnuson-Moss Warranty Act (the "Act"). In addition, you *must* use BBB AUTO LINE if you are required to do so prior to seeking remedies available under the "Lemon Law" of your state. See the appropriate page in the *Owner's Manual Supplement Part 2* in your vehicle glove box for specific requirements applicable in your state. However, if your state law permits and if you choose to seek remedies which are not created by the Act, you are not required to use BBB AUTO LINE, although that option is still available to you.

Please refer to pages 18-20 in this manual for additional information regarding the arbitration process.

Basic Coverage Period

This warranty covers repairs to any part that Toyota supplies that is defective in materials or workmanship under normal use, except those items listed under "What Is Not Covered," for a period of 36 months or 36,000 miles, whichever occurs first. Selected components are warranted for longer periods.

Exceptions

The items specified below are covered for periods different from the basic coverage.

■ **Air Conditioner**

Air conditioner refrigerant charge is covered for the first 12 months, regardless of mileage, unless done as part of a warranty repair.

■ **Adjustments**

Service adjustments — minor repairs not usually associated with the replacement of parts — are covered for the first 12 months or 12,500 miles, whichever occurs first. (**Note:** Adjustments required to pass an emissions test are subject to the applicable emission warranty coverage.)

Powertrain

Engine, transmission, front wheel drive, rear wheel drive, and restraint system components are warranted against defects in materials or workmanship under normal use, except those items listed under “What Is Not Covered,” for a period of 60 months or 60,000 miles, whichever occurs first, from the vehicle’s in-service date. Specific components covered by this warranty are as follows:

- **Engine:** Cylinder block, head, and all internal parts, intake manifold, timing gears and gaskets, timing gear chain/belt and cover, flywheel, valve covers, oil pan, oil pump, engine mounts, water pump, fuel pump, turbocharger housing and all internal parts, supercharger housing, and all internal parts, engine control computer, seals, and gaskets.
- **Transmission and Transaxle:** Case and all internal parts, torque converter, clutch cover, transmission mounts, transfer case, and all internal parts, engine control computer, seals, and gaskets.
- **Front Wheel Drive:** Final drive housing and all internal parts, axle shafts, drive

shafts, constant velocity joints, front hub, and bearings, seals, and gaskets.

- **Rear Wheel Drive:** Axle housing and all internal parts, propeller shafts, U joints, axle shafts, drive shafts, bearings, supports, seals, and gaskets.
- **Restraint System:** Front seat belts, rear seat belts, and air bags.

For vehicles sold and registered in the state of Kansas, the warranty for seat belts and related components is 10 years, regardless of mileage.

Corrosion Perforation

Any body sheet metal found under normal use to have developed a perforation (hole through the body panel) from corrosion due to defects in materials or workmanship is warranted for 60 months, regardless of mileage. (Refer to page 8 for important information about protecting your vehicle.)

Towing

When your vehicle is inoperative due to a warranted part failure, towing service is covered to the nearest authorized dealership.

NEW VEHICLE LIMITED WARRANTY

6

What Is Not Covered

Factors Beyond the Manufacturer's Control

- Repairs and adjustments required as a result of misuse (for example, racing, overloading), negligence, modification, alteration, tampering, disconnection, improper adjustments unless performed by a dealership during warranty repair work or repairs, accident, and use of add-on parts/materials are not covered.
- Cosmetic conditions or surface corrosion from stone chips or scratches in the paint are not covered.
- Damage or surface corrosion from the environment such as acid rain, airborne fallout (chemicals, tree sap, etc.), salt, hail, windstorms, lightning, floods, other acts of God, and the like is not covered.

Lack of Maintenance or Use of Wrong Fuel, Oil, Lubricants, or Fluids

- Repairs and adjustments caused by improper maintenance, lack of required maintenance, or the use of fluids other than fluids specified in the *Owner's Manual* are not covered.

Maintenance Is at Owner's Expense

- Engine tune-up, lubrication, cleaning and polishing, replacement of filters, coolant, fuses, worn wiper blades, and worn brake pads and linings or clutch linings are some of the normal maintenance services all vehicles require and are not covered. Required scheduled maintenance is explained in this supplement.

Normal Noise, Vibration, and Deterioration

- Normal noise, vibration, wear and tear, and deterioration such as discoloration, fading, deformation, or blur are not covered.

Altered Mileage

- Failure of a vehicle on which the odometer mileage has been altered or changed so that vehicle mileage cannot be readily ascertained is not covered.

Tires

- Tires are warranted under a separate warranty provided by the tire manufacturer. Refer to page 17 for tire manufacturer information and warranty details.

Scrapped or Salvaged Vehicles

- A vehicle which has been damaged to such an extent that the owner or the institution financing, leasing, or insuring the vehicle considers it uneconomical to repair it and, as a result, the vehicle is not repaired by or for the person who owns the vehicle at the time of the event resulting in the damage is not covered by the Toyota New Vehicle Limited Warranty, with the exception of any applicable Emission Warranty. This includes, but is not limited to, those vehicles which are currently or were previously titled as "scrap," "salvage," or "dismantled."

Extra Expenses and Damages

Toyota does not authorize any person to create for it any other obligation or liability in connection with this vehicle. ANY IMPLIED WARRANTY OF MERCHANTABILITY OR FITNESS FOR A PARTICULAR PURPOSE APPLICABLE TO THIS VEHICLE IS LIMITED TO THE DURATION OF THIS WRITTEN WARRANTY. The performance of repairs and needed adjustments is the exclusive remedy under this warranty or any implied warranty.

TOYOTA SHALL NOT BE LIABLE FOR INCIDENTAL OR CONSEQUENTIAL DAMAGES (FOR OTHER THAN INJURY TO THE PERSON) RESULTING FROM BREACH OF THIS WRITTEN WARRANTY OR ANY IMPLIED WARRANTY.

Some states do not allow limitations on how long an implied warranty lasts or the exclusion or limitation of incidental or consequential damages, so the above limitations may not apply to you.

This warranty gives you specific legal rights, and you may also have other rights which vary from state to state.

Owner's Responsibilities

Obtaining Warranty Service

You are responsible for delivering your vehicle to any authorized Toyota dealer in the mainland U.S. (excluding Hawaii), Alaska, and Canada in order to obtain warranty service.

Maintenance

You are responsible for properly operating, maintaining, and caring for your Toyota in accordance with the instructions contained in your *Owner's Manual* and this supplement.

If your vehicle is subject to use under severe driving conditions, you should follow the maintenance requirements specified accordingly in the Scheduled Maintenance section of this supplement.

Note: Your dealer may recommend more frequent intervals or may include items which are in addition to those listed in the Scheduled Maintenance section of this booklet. These additional services are not required to maintain your warranty coverage. Please see your dealer for an explanation of any maintenance recommendations which are not part of your vehicle's maintenance schedule.

Maintenance Records

You are responsible for keeping maintenance records since it may be necessary in some instances for you to show that the required maintenance has been performed.

The Maintenance Log in the Scheduled Maintenance section of this supplement provides a convenient way to track and record your vehicle's maintenance history.

Where to Go for Warranty Service

Your Toyota dealer will make the necessary repairs or adjustments using new or remanufactured parts. Repair or replacement of a part is at the discretion of the Toyota dealer. While any Toyota dealer in the mainland U.S., Alaska, and Canada will perform warranty service, Toyota recommends that you return to the dealership which sold you your vehicle because of their continued and personal interest in you.

Customer Assistance

Should you have any questions regarding your warranty coverages or wish to inquire about a special policy adjustment covering your vehicle, please contact the dealership or call Toyota toll-free at 1-800-331-4331.

NEW VEHICLE LIMITED WARRANTY

8

Touring/Relocating Outside the Mainland United States, Alaska, and Canada

If you are touring or relocating outside the mainland U.S., Alaska, and Canada, and a problem arises, please consult a local Toyota dealer. Please note, however, that warranty service may not be provided by the local dealer because the local Toyota distributor may have no obligation to provide warranty service to your vehicle, and/or your Toyota may not comply with the regulatory and/or environmental requirements of such country.

What Can You Do to Help Protect Your Toyota Against Corrosion?

In order to help protect your vehicle against corrosion, it is important that you care for your vehicle regularly, following these suggestions:

- Wash regularly using cold, clean water and a mild vehicle wash soap.
- If insects, tar, or other similar deposits have accumulated on your vehicle, wash it as soon as possible.
- Wash your vehicle in the shade.
- Under certain conditions, special care should be taken to protect your Toyota against corrosion. If you drive on salted or dust-controlled roads, or if you drive near the ocean, hose off the undercarriage at least once a month.
- It is important that the drain holes in the lower edges of the doors and rocker panels be kept clear.
- If you detect any stone chips or scratches in the paint, touch them up immediately.

- If you do much driving on gravel roads, consider installing mud or stone shields behind each wheel.
- If you carry special cargo, such as chemicals, fertilizers, de-icer salt, etc., be sure that such materials are well-packaged and sealed.
- If your Toyota is damaged due to an accident or similar cause which destroys the paint and protective coating, have your vehicle repaired as soon as possible. The cost of such repairs is considered the responsibility of the owner.

This corrosion warranty does not cover non-genuine Toyota sheet metal parts or damage caused by the installation of such non-genuine Toyota sheet metal parts.

Application of additional rust-inhibiting materials is not necessary to protect your new Toyota, nor is it required in order to keep the five-year warranty coverage in effect.

Emission Defect Warranty

TOYOTA warrants to the retail purchaser and each subsequent purchaser that the Toyota vehicle:

- Was designed, built, and equipped so as to conform at the time of sale with regulations of the U.S. Environmental Protection Agency (EPA) as may be applicable.
- Is free from defects in materials and workmanship which may cause the vehicle to fail to conform with the above-mentioned applicable regulations.

EPA regulations require that the warranty is in effect for two years from the date the vehicle is first put into service or 24,000 miles, whichever occurs first. However, Toyota will provide you a coverage of three years or 36,000 miles, whichever occurs first, under the terms of the Basic Warranty. In addition, specific components may be entitled to additional coverage under terms of the Powertrain Warranty.

EPA regulations also require that the warranty for specified major emission control components designated by (*) is in effect for eight years or 80,000 miles, whichever occurs first.

The emission control parts covered by this warranty are listed on page 10.

Emission Performance Warranty

Some states and local jurisdictions have established periodic vehicle inspection and maintenance (I/M) programs to encourage proper maintenance of your vehicle. If an EPA-approved I/M program is in force in your area, you are eligible for emission performance warranty coverage.

EPA regulations require that Toyota make all necessary adjustments, repairs, or replacements at no cost to you if:

- Your vehicle fails to conform to applicable emission standards as determined in an EPA-approved emission test, and
- Such failure results or will result in your having to bear any penalty or other sanctions under local, state, or federal law.

EPA regulations require that the warranty is in effect for two years from the date the vehicle is first put into service or 24,000 miles, whichever occurs first.

In addition, EPA regulations require that the warranty for specified major emission control components designated by (*) is in effect for eight years or 80,000 miles, whichever occurs first.

The emission control parts covered by this warranty are listed on page 10 of this supplement.

Note: Vehicles equipped with a California Certified Emission Control System and registered and normally operated in the state of California or Massachusetts are also entitled to the California Emission Warranty. (See page 13 of this supplement.)

FEDERAL EMISSION WARRANTY

10

Warranty Parts List

AIR/FUEL METERING SYSTEM

- EFI Components
 - Airflow Sensor
 - Throttle Body
 - Engine Control Module*
 - Other Components
- Cold Start Enrichment System
- Deceleration Control
- Air/Fuel Ratio Feedback Control System

AIR INDUCTION SYSTEM

- Intake Manifold and Intake Air Surge Tank
- Turbocharger/Supercharger
- Charge Air Cooler

IGNITION SYSTEM

- Distributor and Internal Parts
- Spark Plugs**
- Ignition Coil and Ignitor
- Ignition Wires

POSITIVE CRANKCASE VENTILATION SYSTEM (PCV)

- PCV Valve or PCV Orifice
- Oil Filler Cap

EVAPORATIVE CONTROL SYSTEM

- Charcoal Canister
- Vapor Liquid Separator
- Fuel Tank
- Fuel Filler Cap

EGR SYSTEM

- EGR Valve
- Associated Parts

AIR INJECTION SYSTEM

- Air Injection Pump
- Airflow Control Valves
- Air Injection Manifold

CATALYST SYSTEM

- Catalytic Converter and Protector*
- Constricted Fuel Filler Neck
- Exhaust Manifold
- Exhaust Pipe (Manifold to Catalyst and/or Catalyst to Catalyst)

MISCELLANEOUS ITEMS USED IN ABOVE SYSTEMS

- Data Link Connector*
- Sensors, Switches, and Valves
- Hoses, Clamps, Fittings, Tubing, Sealing Gaskets or Devices, and Mounting Hardware
- Pulleys, Belts, and Idlers
- Bulbs for malfunctioning indicator (Engine system warning light)*

**Spark plugs warranted until first required maintenance only.

What Is Not Covered

Noncompliance caused by defective replacement parts not certified in accordance with the aftermarket parts certification regulations is not covered.

Noncompliance caused by the use of replacement parts not equivalent to original equipment parts is not covered.

Other provisions specified under the "What Is Not Covered" section in the New Vehicle Limited Warranty are also applicable to this warranty.

Facts About the Emission Warranty

Replacement Parts

The emission control systems of your vehicle were designed, built, and tested using Genuine Toyota Parts. Your vehicle is certified as conforming to applicable federal emission control regulations. Therefore, it is recommended that Genuine Toyota Parts be used as replacement parts.

Use of parts certified in accordance with aftermarket parts certification regulations for repairs and/or maintenance that are paid for by you will not affect the emission warranty coverage. However, use of replacement parts that are not of equivalent quality may impair the effectiveness of the emission control systems. Non-compliance caused by defective replacement parts not certified in accordance with aftermarket parts certification regulations or caused by the use of replacement parts not equivalent to original equipment parts is not covered.

Repairs and Maintenance

The use of any automotive repair establishment or individuals who regularly engage in the business of servicing automobiles for the performance of the maintenance, replacement, or repair of emission control devices and systems that are paid for by you does not affect the emission warranty.

Owner's Responsibility

It is your responsibility to ensure that the vehicle is maintained and operated in accordance with the written instructions for proper maintenance and use as specified in your *Owner's Manual* and this supplement.

In an emergency situation, or to rectify an unsafe condition where an authorized Toyota dealer is not reasonably available, you may perform the repair, or have the repair performed at any service establishment or by a person of your choosing. You will then be required to present the replaced parts and paid repair invoices to an authorized Toyota dealer for reimbursement of the reasonable emergency repair cost.

Maintenance records and receipts should be transferred to each subsequent owner. Toyota will not refuse warranty service based solely on the lack of maintenance or the lack of records showing the maintenance was performed, except when failures are caused by the lack of maintenance.

If you use certified replacement parts that have maintenance or replacement intervals different from those specified in this supplement, you must follow the maintenance and replacement schedule for the certified parts.

FEDERAL EMISSION WARRANTY

12

Filing a Claim With Toyota

A claim may be raised immediately upon the failure of an EPA-approved emission test by following these steps:

1. Take the failed vehicle to any authorized Toyota dealer and present a copy of the emission short test report as evidence of failure. Also, take your maintenance records in case they are needed.
2. The Toyota dealership will inspect your vehicle and determine the warranty applicability within a reasonable period of time (not to exceed 30 days) from your initial vehicle delivery date to any authorized Toyota dealership or within the time period required by local or state law.

3. If for any reason the claim is denied, a written explanation will be presented to you.
4. If Toyota fails to notify you of its decision within the time specified at left for reasons other than those listed below, Toyota shall be responsible for repairing the vehicle free of charge.
 - Delay is requested by you.
 - Delay is caused by factors beyond the control of Toyota or Toyota dealerships.

5. If you wish to obtain further information regarding the emission performance warranty, or if you have failed to receive satisfactory assistance from TOYOTA by following the problem resolution steps outlined in the “How to Get Assistance” section of this supplement, you may contact:

Director, Field Operations and Support Division (EN 397F)
Environmental Protection Agency
401 M Street SW
Washington, D.C. 20460

CALIFORNIA EMISSION CONTROL WARRANTY

Your Warranty Rights and Obligations

The California Air Resources Board (CARB) and Toyota are pleased to explain the emission control system warranty on your 1997 vehicle. In California, new motor vehicles must be designed, built, and equipped to meet the state's stringent anti-smog standards. CARB regulations require that Toyota must warrant the emission control system on your vehicle for the periods of time listed below, provided there has been no abuse, neglect, or improper maintenance of your vehicle.

Your emission control system may include parts such as the fuel-injection system, the ignition system, catalytic converter, and engine computer. Also included may be hoses, belts, connectors, and other emission-related assemblies.

Where a warrantable condition exists, Toyota will repair your vehicle at no cost to you, including diagnosis, parts, and labor.

Manufacturer's Warranty Coverage

1. For 3 years or 50,000 miles, whichever occurs first:
 - If your vehicle fails a smog check inspection, all necessary repairs and adjustments will be made by Toyota to ensure that your vehicle passes the inspection. This is your emission control system PERFORMANCE WARRANTY.
 - If any emission-related part on your vehicle is defective, that part will be repaired or replaced by Toyota. This is your short-term emission control system DEFECTS WARRANTY. In addition, you may be entitled to additional coverage under terms of the powertrain warranty.
2. For seven years or 70,000 miles, whichever occurs first:
 - If an emission-related part listed in this supplement specially noted with coverage for seven years or 70,000 miles is defective, the part will be repaired or replaced by Toyota. This is your long-term emission control system DEFECTS WARRANTY.

Owner's Warranty Responsibilities

As the vehicle owner, you are responsible for the performance of the required maintenance listed in your *Owner's Manual* and this supplement. Toyota recommends that you retain all receipts covering maintenance on your vehicle, but Toyota cannot deny warranty solely for the lack of receipts or for your failure to ensure the performance of all scheduled maintenance.

You are responsible for presenting your vehicle to a Toyota dealer as soon as a problem exists. The warranty repairs should be completed in a reasonable amount of time, not to exceed 30 days.

As the vehicle owner, you should also be aware that Toyota may deny you warranty coverage if your vehicle or a part has failed due to abuse, neglect, improper maintenance, or unapproved modifications.

If you have any questions regarding your warranty rights and responsibilities, you should contact Toyota's Customer Assistance Center toll-free at 1-800-331-4331 or the California Air Resources Board at 9528 Telstar Avenue, El Monte, CA 91731.

CALIFORNIA EMISSION CONTROL WARRANTY

14

Other Warranty Terms

- The warranty period begins on the date the vehicle is first delivered to the ultimate purchaser or on the date it is first placed in service as a “demonstrator” or “company” car.
- Parts that are scheduled for replacement as required maintenance are warranted up to their first replacement point.
- If you use a replacement part that has maintenance or replacement intervals different from those specified in this supplement, you must follow the maintenance and replacement schedule for the replacement part.
- Maintenance records and receipts should be transferred to each subsequent owner.
- After the three years or 50,000 miles emission performance warranty period has passed, a defect in a part which is warranted for seven years or 70,000 miles long-term emission defect warranty found during a smog check test failure is covered. In addition to the California emission performance warranty, Toyota would like to inform you that your vehicle is also subject to Federal emission performance warranty guidelines applicable to specified major emission control components for a period of eight years or 80,000 miles. See

page 8 of this supplement for an explanation of this warranty coverage.

- The defect warranty covers any part on the vehicle which affects any regulated emissions.

What Is Not Covered

These warranty obligations will not apply:

- Should tampering, abuse, neglect, or improper maintenance be found as the direct cause of the need for repair, replacement, or adjustment.
- Should noncompliance be caused by the use of replacement parts not equivalent to original Toyota parts.

Other provisions specified under the “What Is Not Covered” section in the New Vehicle Limited Warranty are also applicable to these warranties.

Long-Term Emission System Defect Warranty Parts List

The parts on this list are covered for a period of seven years or 70,000 miles, whichever occurs first.

AIR/FUEL METERING SYSTEM

- Engine Control Module
- Throttle Body

- Volume Air Flow Sensor
- Mass Air Flow Sensor
- Manifold Absolute Pressure Sensor
- Idle Air Control Valve on Supra and Land Cruiser Wagon 4WD
- Injector on Supra equipped with 2JZ-GTE

AIR INDUCTION SYSTEM

- Intake Manifold and Intake Air Surge Tank
- Intake Manifold Gasket on RAV4 2WD, RAV4 4WD, Land Cruiser Wagon 4WD
- Charge Air Cooler
- Supercharger
- Turbocharger
- Intake Air Control Valve

IGNITION SYSTEM

- Distributor and Internal Parts
- Knock Sensor on Camry and Avalon equipped with 1MZ-FE; Previa, Previa All-Trac; T100 2WD, T100 4WD; Tacoma 2WD, Tacoma 4WD; 4Runner 2WD, 4Runner 4WD equipped with 5 Z-FE
- Ignitor on Avalon

CATALYST SYSTEM

- Exhaust Manifold on Supra equipped with 2JZ-GTE, Camry and Avalon equipped with 1MZ-FE
- Right Exhaust Manifold Gasket on Camry and Avalon equipped with 1MZ-FE
- Catalytic Converter (Warm-Up Three-Way Catalyst)

- Exhaust Front Pipe on Tercel, Paseo, Camry, Avalon, Supra, Previa, Previa All-Trac, Land Cruiser Wagon 4WD, 4Runner 2WD, 4Runner 4WD
- Exhaust Center Pipe on Previa, Previa All-Trac, T100 2WD, T100 4WD
- Turbine Outlet Elbow

EVAPORATIVE CONTROL SYSTEM

- Fuel Tank

EGR SYSTEM

- EGR Pipe on Land Cruiser Wagon 4WD

Facts About the Emission Warranty

Replacement Parts

The emission control systems of your vehicle were designed, built, and tested using Genuine Toyota Parts, and the vehicle is certified as being in conformity with applicable federal and California emission control regulations. Therefore, it is recommended that replacement parts used be Genuine Toyota Parts.

Use of parts that are equivalent to Genuine Toyota Parts for repairs and/or

maintenance that are paid for by you will not affect the emission warranty coverage. However, use of replacement parts that are not of equivalent quality may impair the effectiveness of the emission control systems. If other than Genuine Toyota Parts are used for maintenance, replacement or repair of components affecting emission control, you should ensure that such parts are warranted by their manufacturers to be equivalent to Genuine Toyota Parts in calibration, performance, and durability.

Repairs and Maintenance

The performance of required scheduled maintenance by you or by a person of your choosing or the use of any automotive repair establishment or individuals who regularly engage in the business of servicing automobiles for the performance of the maintenance, replacement, or repair of emission control devices and systems that are paid for by you does not affect the emission warranty.

Emergency Repairs

In an emergency situation or to rectify an unsafe condition where an authorized Toyota dealer is not reasonably available, or a part is not available within 30 days, or a repair is not completed within 30 days, you may perform the repair, or you may have the repair performed at any service establishment or by a person of your choosing. Any replacement part may be used in an emergency situation; however, Toyota will not assume liability for subsequent failure caused by the use of non-equivalent parts unless you have taken steps to put the vehicle back in a conforming condition in a timely manner. You will then be required to present the replaced parts and copies of paid repair invoices to an authorized Toyota dealer for reimbursement of expenses, including diagnostic charges, not to exceed the manufacturer's suggested retail price for all warranted parts replaced and labor charges based on the manufacturer's recommended time allowance for the warranty repair and the geographically appropriate hourly labor rate.

CALIFORNIA EMISSION CONTROL WARRANTY

16

Filing a Claim With Toyota

To file a claim for a defect, bring your vehicle to any authorized Toyota dealer.

If your vehicle fails a California smog check test, a claim may be raised by following these steps:

1. Take the failed vehicle to any authorized Toyota dealer and present a copy of the emission test report as evidence of failure. Also, take your maintenance records in case they are needed.
2. If the repair is covered under warranty, the Toyota dealership will perform the repair within a reasonable period of time (not to exceed 30 days) from your initial vehicle delivery date to any authorized Toyota dealership or within the time period required by local or state law.
3. If for any reason the claim is denied, a written explanation will be presented to you.
4. If Toyota fails to notify you of its decision within the time specified above for reasons other than those listed below, Toyota shall be responsible for repairing the vehicle free of charge.
 - Delay is requested by you.
 - Delay is caused by factors beyond the control of Toyota or Toyota dealerships.
5. If you have failed to receive satisfactory assistance from TOYOTA by following the problem resolution steps outlined in the "How to Get Assistance" section of this supplement, you may contact:

California Air Resources Board
Mobile Source Division
9528 Telstar Avenue
El Monte, CA 91731
1-800-242-4450

Director, Field Operations and Support Division (EN397F)
Environmental Protection Agency
401 M Street SW
Washington, D.C. 20460

What Is Covered

Each tire supplied as original equipment on a new 1997 Toyota vehicle is warranted separately by the tire manufacturer. Please refer to the separate tire manufacturer's warranty statement in your vehicle glove box for exact coverage.

Obtaining Warranty Service

You are responsible for delivering the vehicle with the unserviceable tire to any authorized dealer of the tire manufacturer in order to obtain warranty service. For the location of authorized tire dealers, please refer to your local telephone directory. Your Toyota dealer may also assist you in obtaining warranty coverage from the tire manufacturer.

The Tire Warrantors

Detailed tire warranty information and regional customer service phone numbers (where applicable) can be obtained by contacting the tire warrantors listed on this page.

The Respective Tire Warrantors Are:

Bridgestone/Firestone, Inc.

One Bridgestone Park
Nashville, TN 37214
1-800-847-3272

Toyo Tire (USA) Corporation

6415 Katella Ave.
Cypress, CA 90630
1-800-442-TOYO
1-800-238-TOYO

Goodyear Tire and Rubber Company

1144 East Market Street
Akron, OH 44316
1-800-321-2136

Yokohama Tire Corporation

601 S. Acacia Ave.
P.O. Box 4550
Fullerton, CA 92631-4550
1-800-722-9888

Dunlop Tire Corporation

P.O. Box 1109
Buffalo, NY 14240
1-800-548-4714

Michelin North America

One Parkway South
P.O. Box 19001
Greenville, SC 29602-9001
1-800-847-3435

Ohtsu Tire and Rubber Co., Ltd.

2539 237th St., Unit-A
Torrance, CA 90505
1-800-468-5448

General Tire

One General Street
Akron, OH 44329-0007
1-800-847-3349

ARBITRATION

18

BBB AUTO LINE Arbitration

If you should experience a problem which has not been resolved to your satisfaction through the first two steps of Toyota's complaint handling process, Toyota offers additional assistance through the COUNCIL OF BETTER BUSINESS BUREAUS' (CBBB's) BBB AUTO LINE arbitration program.

What Is BBB AUTO LINE?

BBB AUTO LINE is comprised of local BBB professionals who are trained and experienced in arbitration. BBB will arbitrate your case by reviewing the facts, inspecting the vehicle, if necessary, and promptly rendering a fair and equitable decision.

What Types of Disputes Are Eligible?

BBB AUTO LINE arbitrates disputes involving Toyota's product reliability or warranty performance which arise during the greater of 1) three years or 36,000 miles from the vehicle's in-service date, whichever is earlier, or 2) the applicable provision of Toyota's New Vehicle Limited Warranty. However, BBB AUTO LINE will not arbitrate claims involving a vehicle used primarily for commercial purposes unless the "Lemon Law" of your state covers vehicles used for commercial purposes or claims that an air bag failed

to deploy or deployed when it should not have. You must file a request for arbitration with BBB AUTO LINE within 60 days of the expiration of the eligibility period, provided the concern or alleged defect was brought to the attention of Toyota or one of its dealers during the eligibility period.

How Long Is the Arbitration Process?

The entire process, from the time BBB AUTO LINE receives your request for arbitration to the arbitrator's decision, is designed to take no more than 40 days. In some cases a decision may be delayed because of:

- Your failure to provide certain information required by BBB AUTO LINE or your failure to make the vehicle available for inspection by BBB AUTO LINE in a timely manner when an inspection is necessary.
- Your failure to contact Toyota about your dispute before requesting arbitration.

The letter from BBB AUTO LINE advising you of its decision will specify that Toyota must comply with the decision shortly, usually within 30 calendar days. CBBB will contact you to ensure that Toyota has complied in a timely manner.

How Much Will it Cost?

There is no charge to you for submitting your dispute to BBB AUTO LINE. You may obtain copies of your case for a nominal fee from CBBB.

When to Use BBB AUTO LINE

Because most situations can be resolved by our customer satisfaction network, we recommend that you request arbitration only after utilizing Toyota's Steps 1 and 2 of the customer assistance process described earlier on page 3.

You must use BBB AUTO LINE prior to seeking remedies available to you through a court action pursuant to the Magnuson-Moss Warranty Act (the "Act"). In addition, you must use BBB AUTO LINE if you are required to do so prior to seeking remedies available under the "Lemon Law" of your state. See the appropriate page in the *Owner's Manual Supplement Part 2* in your vehicle glove box for specific requirements applicable in your state. However, if your state law permits and if you choose to seek remedies which are not created by the Act, you are not required to use BBB AUTO LINE, although that option is still available to you.

How to Request Arbitration

Complete the BBB AUTO LINE Customer Claim form, available through Toyota's Customer Assistance Center (by calling toll-free at 1-800-331-4331) or found at the center of your Toyota *Owner's Manual Supplement Part 2*. You will need the following information:

- Vehicle year, make, model, vehicle identification number (VIN), mileage, date of purchase.
- A brief description of your complaint and actions you have taken to resolve it.
- Enclose copies of invoices with your request for arbitration if you are seeking reimbursement for repairs or related incidental expenses.
- What action or remedy would resolve your problem.

Send your request to:

BBB AUTO LINE
4200 Wilson Blvd., Suite 800
Arlington, VA 22203

How Does the Arbitration Process Work?

When BBB AUTO LINE receives your request, it will be forwarded to the Toyota regional office/private distributor for response.

After receiving and analyzing all pertinent documentation, if applicable, BBB AUTO LINE will schedule a technical evaluation. This may include an inspection of the vehicle with a Toyota representative present.

An oral hearing will be held prior to the decision being rendered if you request it.

At the oral hearing, all evidence is admissible. In an oral hearing, you and a Toyota representative will present both sides of the case to the BBB AUTO LINE arbitrator. Each of you will be allotted approximately 30 minutes to give testimony and provide documents. Then you and Toyota will be given approximately 10 minutes each for rebuttal.

A settlement satisfactory to all parties may be negotiated during the mediation/arbitration process prior to submission of the case to the arbitrator.

If a technical evaluation was made, the technical expert will forward the technical evaluation report to the BBB AUTO LINE program.

At the oral hearing, an arbitrator will listen to all testimony and review all of the information available and the applicable legal standards and render a decision within 10 days of hearing completion.

What Types of Decisions Are Rendered, and How Do I Know If Toyota Will Abide by BBB AUTO LINE's Decision?

BBB AUTO LINE's decisions are based on what it believes is fair and appropriate under the circumstances after applying the appropriate legal standards. Remedies include, but are not limited to, repairs; reimbursement for repair or incidental expenses, such as towing costs; or repurchase or replacement of your vehicle. BBB AUTO LINE's decision is binding on Toyota, but not on you, the customer. Toyota must comply with the decision shortly after it is rendered, usually within 30 days. CBBB will contact you within 10 working days of scheduled performance to ensure that Toyota has complied with the decision in a timely manner.

ARBITRATION

20

Are There Limits on the Scope of BBB AUTO LINE Decisions?

BBB AUTO LINE decisions will not include:

- Attorney Fees
- Punitive Damages
- Multiple Damages
- Consequential Damages other than incidental damages which you may be entitled to under law.

What Other Recourse Do I Have Available?

If you are dissatisfied with the arbitrator's decision or Toyota's performance, you may pursue any other legal remedies which you may have including small claims court. You should be aware that the arbitration findings are admissible as evidence in any subsequent legal proceedings concerning your dispute.

Is the BBB AUTO LINE Program Subject to Change?

The information about BBB AUTO LINE in this *Owner's Manual Supplement* was correct as of the date of printing. The program may, however, be changed without notice. Contact Toyota at 1-800-331-4331 or BBB AUTO LINE if you have any questions about BBB AUTO LINE.

The Experts Say, “Buckle Up!”

The importance of using seat belts cannot be overemphasized. The safety experts from government and private organizations say “Buckle Up!” Here are a few good reasons why:

- Properly adjusted seat belts can help reduce driving fatigue and help the driver maintain better vehicle control.
- Studies show that generally the safest place in a collision is inside your vehicle. Seat belts can help keep you there.
- Eight out of ten injury accidents occur at speeds under 40 mph, but even below 5 mph children can be injured during quick turns or sudden stops. Children who are too small to wear regular seat belts should always be provided with a Child Restraint System dynamically tested to meet federal standards.

In addition to seat belts, many Toyota vehicles are equipped with both driver's and passenger's side supplemental restraint systems (SRS air bags). Air bags have been designed to supplement the three-point seat belt by providing additional protection by

restraining the forward motion in the event of a more serious frontal accident. **The SRS does not replace use of the seat belt.** To obtain maximum protection in an accident, the driver and all passengers in the vehicle should always wear their seat belts.

Get That Good Feeling

Familiarize yourself with the operation of your seat belts, as explained in your *Owner's Manual*. Wear them every time you drive your new Toyota, and encourage those who ride with you to do the same.

Remember: For peace of mind, buckle up ... it's a good feeling!

Audio Systems

Your Toyota's original equipment radio and sound system components are covered under the terms of the Toyota New Vehicle Limited Warranty.

In the unlikely event your radio does require service, any authorized Toyota dealer is prepared to minimize inconvenience by exchanging your radio/sound system rather than sending it out for repair.

How it works:

- If the dealership determines that the radio cannot be repaired at the dealership, they will order a replacement radio and return your car to you.
- Once your replacement radio arrives at the dealership (usually within a few days), it will be installed in your vehicle at your convenience and you're on your way!

Note: In general, radio performance and particularly FM reception may be affected by such factors as natural terrain, man-made obstacles, and your distance from the radio station's transmitter. Please consult your *Owner's Manual* for further information on radio operation and performance.

EXTENDED PROTECTION FOR YOUR VEHICLE

22

Long-Term Commitment

Toyota is committed to your long-term satisfaction. It is our commitment to provide quality service for as long as you own your new Toyota, no matter how long that may be.

Today's marketplace has seen vehicle replacement costs accelerate, and many of our customers are deciding to keep their Toyotas longer. Consequently, many of you are concerned about the potential costs for major repairs as your Toyota ages. It is for this reason that more than 1,100 Toyota dealerships across the country now offer Toyota "Extra Care" or a similar service agreement for your vehicle.

Extended Protection

The Vehicle Service Agreement provides extended protection against unexpected repairs beyond the factory warranty on your Toyota. It helps you minimize the risk of these potential future costs.

Various service agreements are available to meet almost every vehicle protection need. Most plans offer additional service conveniences:

- Nationwide coverage
- Vehicle towing
- Substitute transportation
- Protection when you travel
- Transferability
- Easy claim service

Vehicle service agreements may be purchased directly through your local Toyota dealer. Each program is specific as to time, mileage, and component coverages. It is to your advantage to select a vehicle service agreement program that fully provides the extended coverage you desire. Your Toyota dealer can help you select the plan that is best for your protection needs.

Preventive Service

Toyota is also aware that in today's market the cost of keeping a vehicle well maintained is ever increasing. Your Toyota dealer can help you manage service costs by offering you the option of pre-paying for vital services and inspections for your new Toyota. *Toyota Auto Care* or similar preventive service plans are offered by most Toyota dealers. These plans, like *Toyota Auto Care*, may include some of the following benefits:

- Engine oil and filter change
- Lubrication of key chassis parts
- 19-point inspection
- Emergency 24-hour roadside assistance
- Timed service reminders
- Computerized service history
- Transferability

Different intervals may be selected to meet your specific service needs. Ask your Toyota dealer about the many different plans available to help protect your vehicle for the years ahead.



T O Y O T A E X T R A C A R E



A U T O C A R E

WE SUPPORT

Toyota Quality Service

Part of the care that all vehicles require is regular replenishment of fluids, lubricants, and maintenance parts to guard against premature wear or failure. In addition, regular inspection of a vehicle's overall mechanical condition by trained technicians can provide the opportunity for minor repairs to be carried out quickly and economically before they lead to more extensive problems. Toyota's Recommended Maintenance Schedule provides factory-recommended guides for maintenance and inspection based on mileage, time, and the conditions under which the vehicle is regularly driven.

With proper maintenance, your Toyota will last longer and deliver maximum performance and reliability. Please see page 29 for your model's recommended maintenance schedule. Follow the schedule to help your Toyota serve you economically for many years to come.

Toyota Supports Technician Certification

The skill of the technician who actually services or repairs your Toyota is vitally important to your vehicle's operation and efficiency. To make sure your Toyota dealer gives you the best service available anywhere, Toyota created the Toyota Certified Technician Program. In addition, over 90 percent of all Toyota dealers participate in the technician certification program of the National Institute for Automotive Service Excellence (ASE).

Certified technicians are proven professionals. They have earned their certification by attending Toyota Technical Training classes and by passing a series of comprehensive written examinations. Next time you visit, ask your Toyota dealer to show you the technicians' credentials.

Genuine Toyota Parts

A network of more than 1,100 Toyota dealers throughout the U.S. is your guaranteed source for quality Genuine Toyota Parts. Genuine Toyota Parts are engineered and manufactured to the same high standards of quality and performance built into every Toyota product.

This extensive dealer network is dedicated to providing the parts you need to service your Toyota vehicle. Each dealer's parts inventory is further supplemented by a nationwide system of 11 electronically connected and strategically located Toyota Parts Distribution Centers. This comprehensive system provides the assurance that virtually any part from any Toyota vehicle in the U.S. is readily available to meet your parts and service needs.

TOYOTA PARTS CENTERS

24

Toyota Parts Centers

A network of over 430 Toyota dealerships throughout the U.S. offers one-stop shopping convenience for Toyota Do-It-Yourselfers. A Toyota Parts Center (TPC) is a parts store within the dealership that offers a full selection of automotive products. Included are Genuine Toyota maintenance and repair parts, Genuine Toyota Accessories, and a full line of brand name car-care products at competitive prices.

Most TPCs are open Saturdays and some evenings. Expert technical help is available to answer DIY parts questions. Also, "How To" brochures covering most common maintenance jobs and Toyota model-specific pocket application catalogs are available free of charge.

Stop by your local TPC and experience the service and value available to Toyota DIYers.



FPO

Toyota Express Lube

Toyota Express Lube dealers offer you a complete oil and filter change and 19-point inspection, in 29 minutes or less, *guaranteed*, or your next one's free! Toyota Express Lube combines all the convenience and value of a quick oil change with the quality and reliability of Genuine Toyota Parts and trained technicians that you've come to trust.

For a Toyota Express Lube oil change, no appointment is ever necessary. Just follow the signs and drive up to the Express Lube lane—you will be waited on promptly, and your guaranteed 29 minute oil and filter change will be done while you wait. And it's a great value too—Toyota Express Lube service is typically priced very competitively with franchised quick lube centers.

Call Toyota's Customer Assistance Center at 1-800-331-4331 for the nearest Toyota Express Lube location, and "*Catch the Express!*"



LIFETIME GUARANTEE PROGRAM

26

A Commitment to Quality and Customer Satisfaction

Toyota guarantees you'll only have to pay once! That's right; if replacement is ever necessary, for as long as you own the vehicle, Toyota provides complete parts *and* labor coverage for mufflers, exhaust pipes, shock absorbers, struts, and strut cartridges when you purchase these items and have them installed by your authorized Toyota dealer. This Lifetime Guarantee is our way of demonstrating to you Toyota's commitment to quality and customer satisfaction.

Remember, these top-quality Genuine Toyota Parts are manufactured to meet Toyota's high standards for fit and function. So don't compromise; when replacement time comes, count on your Toyota dealer for a lifetime!

Toyota mufflers, exhaust pipes, shocks, struts, and strut cartridges are guaranteed to the original purchaser for the life of the vehicle when installed by an authorized Toyota dealer. See dealer for full details.

Compare Lifetime Guarantee Coverage

Toyota vs. Others		
	Toyota	Others*
• Muffler	Yes	Yes
- Labor to replace	Yes	Yes
• Tail Pipe	Yes	No
- Labor to replace	Yes	No
• Exhaust Pipes	Yes	No
- Labor to replace	Yes	No

Theirs

**We Cover
The Muffler,
Pipes And
Labor Too!**

Ours

* Some muffler shops—read their fine print and compare.

Genuine Toyota Chemicals

The Toyota Chemical Line is engineered to serve your car care needs. Formulated specifically for use with Toyota vehicles, this quality lineup includes everything for the care and maintenance of Toyota cars and trucks.

The Toyota Chemical Line includes appearance products, such as Liquid Car Wash and Fabric Spot Remover, and service items such as Rust Penetrants, Brake Cleaner, and EFI Injector Cleaner. All products are produced to meet or exceed Toyota's warranty requirements.

Toyota Antifreeze/Coolant

- Helps provide excellent long-term corrosion protection.
- Does not contain silicates that may harm water pump seals.
- Is specially formulated for Toyota engine cooling systems.
- Is tested and approved by Toyota.
- Is produced to meet or exceed Toyota's warranty requirements.



Toyota Motor Oils

- Are specially formulated for Toyota gasoline engines.
- Are tested and approved by Toyota.
- Are produced to meet or exceed Toyota's warranty requirements.

- Are approved for Toyota turbocharged engines.
- Are formulated to help save gas by reducing engine friction.

DEALER CERTIFICATE

28

We (the Dealer) want you to know that at the time your new _____ is being delivered that:

1. Based upon written notification furnished by TOYOTA, we have knowledge that this vehicle is covered by an Environmental Protection Agency (EPA) Certificate of Conformity.
2. We have made a visual inspection limited to those emission control devices or portions thereof which are visible without removal or adjustment of any components or systems of the vehicle, whether emission-related or otherwise. Based upon such visual inspection, there are no apparent deficiencies in the installation of emission control devices by TOYOTA. ("Emission control device" is limited for purposes of this certificate to all devices installed on a vehicle for the sole or primary purpose of controlling vehicle emissions and which were not in general use prior to 1968.)

3. We have performed all emission control system preparations required by TOYOTA prior to the sale of the vehicle, as set forth in the current predelivery service manual provided by TOYOTA.
4. Except as may be provided in Paragraph 5 below, if this vehicle fails an EPA-approved emission test prior to the expiration of three months or 4,000 miles (whichever comes first) from the date or mileage at the time of delivery to the ultimate purchaser, and the vehicle has been maintained and used in accordance with the written instructions for proper maintenance and use, then TOYOTA shall remedy the non-conformity free of charge to the vehicle owner under the terms of TOYOTA's emission performance warranty.
5. Check if the vehicle is a company car or demonstrator and complete the following:

The vehicle with which this statement was delivered was placed in service as a demonstrator or company car prior to delivery. TOYOTA's emission performance warranty period commenced on the date the vehicle was first placed in service, namely on _____

Note: The dealer makes no representation or warranty that the emission control system or any part thereof is without defect nor that the system will properly perform. TOYOTA's emission performance warranty referred to above furnished with the vehicle is solely that of the manufacturer.

This statement is required by section 207 of the Clean Air Act (42 U.S.C. 7541) and the EPA regulations issued thereunder.

(Dealership Name)

OWNER INFORMATION CHANGE



NO POSTAGE
NECESSARY
IF MAILED
IN THE
UNITED STATES

BUSINESS REPLY MAIL
FIRST CLASS MAIL PERMIT NO. 449 TORRANCE, CA 90509

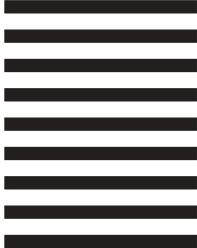

POSTAGE WILL BE PAID BY ADDRESSEE

DIRECT RESPONSE DEPARTMENT A207
TOYOTA MOTOR SALES USA INC
PO BOX 2991
TORRANCE CA 90509-9941



OWNER INFORMATION CHANGE

EVV

NAME/ADDRESS INFORMATION FORM

Check One:

Same Owner, Name and/or Address Changed

Same Owner, Additional Driver

New Owner

No Longer Have Vehicle—Sold or Traded to Individual Listed Below

Vehicle Identification Number (VIN)

Effective Date of This Information

Mo.

Day

Year

Mr.

Mrs.

Ms.

Miss

Dr.

Individual OR

First Name

M.I.

Last Name

Company:

Company Name

Address/P.O. Box

Apt./Suite Number

City

State

ZIP Code

Home Telephone Number

Ext.

Work Telephone Number

Ext.

Social Security Number/
Customer Reference

Do not include on future mailings

OWNER INFORMATION CHANGE

|||||
FPO
|||||

NO POSTAGE
NECESSARY
IF MAILED
IN THE
UNITED STATES

BUSINESS REPLY MAIL

FIRST CLASS MAIL

PERMIT NO. 449

TORRANCE, CA 90509

POSTAGE WILL BE PAID BY ADDRESSEE

DIRECT RESPONSE DEPARTMENT A207
TOYOTA MOTOR SALES USA INC
PO BOX 2991
TORRANCE CA 90509-9941

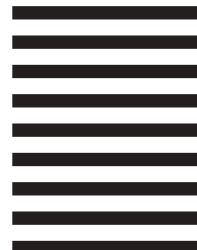

||||| **FPO** |||